

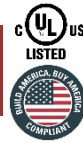

# BASELITE - ARBOR – LED – SPECIFICATION SHEET



PROJECT NAME: \_\_\_\_\_ PROJECT TYPE: \_\_\_\_\_

NOTES: BABA COMPLIANT

\*FOR A COMPLETE MODEL NUMBER, MAKE A SELECTION FROM THE DROP DOWNS BELOW. SKIP SECTIONS THAT DO NOT APPLY.

MODEL #  
EXAMPLE: W513 41 E16 SQ 1/2" 43 45LED 3K LDM120 PR3 GR13 44

## A - SHADES

### ARBOR

- W511 - 25LED (MAX)
- W5114 - 25LED (MAX)
- W513 - 25LED (MAX)
- W5134 - 25LED (MAX)
- W517 - 35LED (MAX)
- W5174 - 35LED (MAX)
- WV5174 - 35LED (MAX)
- SWS17 - 35LED (MAX)
- W5175 - 35LED (MAX)
- W5136 - 35LED (MAX)

## B - FINISH OPTIONS

(SEE WEBSITE FOR SWATCH COLORS)  
(\*SEE NOTES FOR LIMITATIONS\*)

- 14, 15, 16, 17, 18, 19, 19P, 20, 20P, 20PB, 20SB, 21, 21P, 22, 22P, 23, 23P, 38, 39, 40, 41, 41.5, 42, 43, 44, 45, 46, 48, 49, 50, 51, 52, 53, 54, 55, 57, 58, 59, 60, 61, 62, 63, 64, 65, 66, 70, 71, 72, 73, 74, 75, 76, 77, 78, 79, 80, 81, 82, 83, 84, 85, 86, 87, 88, 89, 90, 91, 92, 93, 94, 95, 96, 97, 98, 99, 100, MG.

## C - MOUNTING OPTIONS

### 1/2" ARM EXTENSIONS

E1, E2, E2S, E3, E4, B1, E16, E17, E24, E27

### 3/4" ARM EXTENSIONS

E3A, E4A, E5, E6, E7, E8, E9, E10, E11, E12, E13, B15, B15S, E19, E20, E21, E25

### E14 - CREATE YOUR OWN

(BASELITE WILL TAKE YOUR SKETCH AND FABRICATE A CUSTOM ARM EXTENSION TO MEET YOUR NEEDS).

### 1/2" WALL MOUNT

B13, WM13R, WM13X, B10, B11, B101

### 3/4" WALL MOUNT

B9, B9C, B12, WM14X, WM15, WM35X, WM55X, WM60X, WM61X WM70X, WM71X

### LED CORD MOUNT

LBLC, LWHC, LTCB, LTCW, LTCHB, LTCHW, LTLB, LTLW, LTLB, LTLW, LRCB, LRCW, LRCHB, LRCHW, LFHB, LFHW, LHBL, LHWHC, LCBLC, LCWHC, LCHB, LCHW

### STEM MOUNT

ST6, ST12, ST18, ST24, ST36, ST48, STXX

## D - MOUNTING ADD-ONS

### LED ADD-ONS

LWTM, LSLC, LSTC

### UNIVERSAL ADD-ONS

SQ 1/2", SQ 3/4", FH 1/2", FH 3/4", TRB 1/2", TRB 3/4", SWL, LGSWL, CNK, INB, RINB

## E - MOUNTING COLOR

SEE SECTION "B" FOR COLOR OPTIONS.

## F - WATTAGE

(SEE PAGE 4 FOR WATTAGE LIMITATIONS)

### LED WATTAGE OPTION

10, 12, 25, 35

\*NOTE - MAX WATTAGE IS LISTED NEXT TO THE SHADE MODEL NUMBER IN SECTION "A". ALL WATTAGES BELOW THAT ARE ALSO AVAILABLE FOR THE SAME MODEL NUMBER.

## G - LED COLOR TEMP

- 27K - 2700 KELVIN
- 3K - 3000 KELVIN
- 35K - 3500 KELVIN
- 4K - 4000 KELVIN
- 5K - 5000 KELVIN

## H - ELECTRICAL OPTION

(SEE PAGE 4 FOR DIMMING OPTION SPECIFICATIONS)

### LDM120

LDM0-10

## I - GLASS OPTIONS

CL3, CL4, BL3, BL4, RE3, RE4, GR3, GR4, AH3, AH4, FR3, FR4, PR3, PR4, BA, BAX, BAF, PR8, PR8F, FN, OC

## J - ACCESSORIES

GR11, GR13, GR17, REF, UGR, LGR11, LGR13, LGR17, CRL13, CRL17, FLE11, FLE13, FLE17, FGR11, FGR13, FGR17, GU-1, GU-2, WG-1, WG-2

## K - ACCESSORY COLOR

SEE SECTION "B" FOR COLOR OPTIONS.

## NOTES

- (1). FINISH OPTIONS 20, 21, 22, 23 ARE FOR SOLID BRASS FIXTURES ONLY.
- (2). FINISH OPTIONS 19, 21, 22, 23, 75, 76, 77, 83, 84, 88, 93 AND 98 ARE APPLIED BY HAND. THESE FINISHES WILL VARY IN CONSISTENCY.
- (3). FINISH OPTIONS 19, 38, 39, 40, 49, 54, 57, 58, 61, 62, 63, 70, 71, 72, 73, 78, 83, 84, 88, 92, 93, 98 ONLY AVAILABLE INSIDE AND OUT OF FIXTURE. OTHER FINISHES ARE WHITE INSIDE.
- (4). FINISH OPTIONS 61, 62, 70, 71, 72, 73 ARE FINISHED WITH A SUPERCHROME ON THE INSIDE FOR ALL LED LIGHT SOURCE OPTIONS.
- (5). COLOR CORDS ARE NOT APPLICABLE FOR LED OPTIONS.
- (6). ALL ARMS COME WITH A CAST BACKPLATE (CB1/2", CB3/4", LWTM, CFWTM, ECT.).
- (7). ACCORDING TO THE LIGHT SOURCE THE BACKPLATE MAY VARY IN SIZE. (EXAMPLE: LED LIGHT SOURCE WILL HAVE A DEEPER BACKPLATE TO HOUSE THE DRIVER.).
- (8). ALL FIXTURES MOUNT TO A 4-O JUNCTION BOX.
- (9). FIXTURE DIMENSIONS MAY VARY ±0.25.
- (10). CORD AND CANOPY COME IN THE SAME COLOR.

## SHADE DIMENSIONS

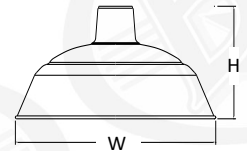

**W513** H-8" W-13"  
**W517** H-8" W-17"

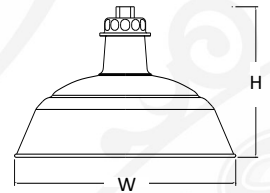

**W5134** H-9.5" W-13"  
**W5174** H-9.5" W-17"

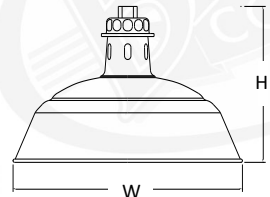

**WV5174** H-9.5" W-17"  
\*SHADE RATED FOR DRY LOCATION ONLY

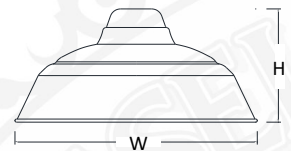

**SWS17** H-9" W-17"

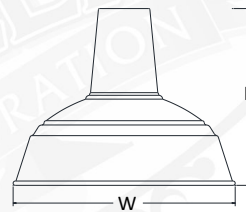

**W5136** H-10.25" W-13"

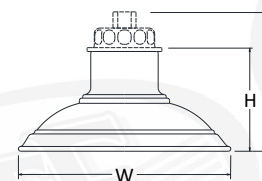

**W511** H-5.5" W-11"

**W5114** H-7.5" W-11"

\*W5114 - WITH CAST ALUMINUM TOP  
\*W511 - NO TOP

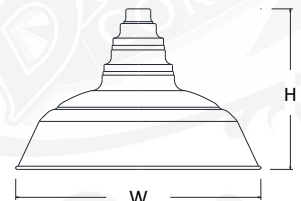

**W5175** H-11" W-17"



**C - MOUNTING OPTIONS**

**1/2" ARM EXTENSIONS**

\*ARMS RATED FOR WET LOCATION \* MAXIMUM SECTIONS OF ARMS ARE DIMENSIONED



**E1** 9"(H) 19.75"(W)



**E2** 13.5"(H) 36.75"(W)



**E2S** 13.5"(H) 35"(W)



**E3** 16.5"(H) 26.5"(W)



**E4** 14.5"(H) 24"(W)

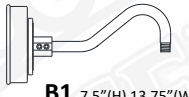

**B1** 7.5"(H) 13.75"(W)

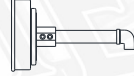

**E16** 6"(H) 10.25"(W)



**E24** 9.5"(H) 24"(W)

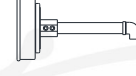

**E17** 6"(H) 11.25"(W)



**E27** 9"(H) 12.25"(W)

**3/4" ARM EXTENSIONS**

\*ARMS RATED FOR WET LOCATION \* MAXIMUM SECTIONS OF ARMS ARE DIMENSIONED



**E20** 85.5"(H) 27.25"(W)

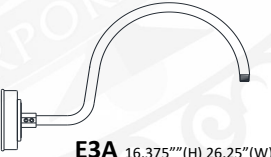

**E3A** 16.375"(H) 26.25"(W)

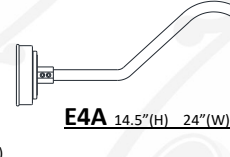

**E4A** 14.5"(H) 24"(W)

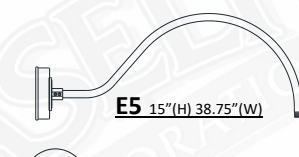

**E5** 15"(H) 38.75"(W)

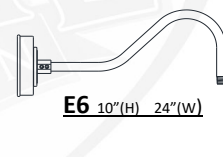

**E6** 10"(H) 24"(W)

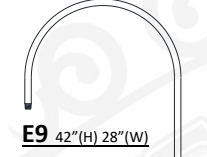

**E9** 42"(H) 28"(W)

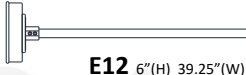

**E12** 6"(H) 39.25"(W)

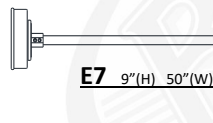

**E7** 9"(H) 50"(W)



**E10** 18"(H) 56"(W)

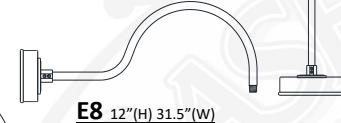

**E8** 12"(H) 31.5"(W)

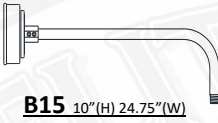

**B15** 10"(H) 24.75"(W)

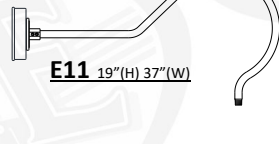

**E11** 19"(H) 37"(W)

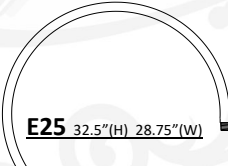

**E25** 32.5"(H) 28.75"(W)



**E13** 30.5"(H) 27"(W)

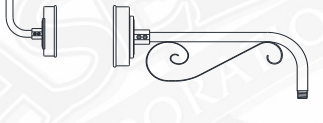

**B15S** 10"(H) 19.75"(W)



**E21** 12"(H) 28.75"(W)



**E19** 10.625"(H) 11.5"(W)

**NOTES:**



- \* All arms sold with Cast Backplate (CB)
- \* Backplate may vary in size depending on light source.

**E14**



- \* Baselite will take your sketch and fabricate a custom arm extension to meet your needs
- \* Dimensions to be determined by customer

**1/2" WALL MOUNTS**

\*MOUNTS RATED FOR WET LOCATION \* MAXIMUM SECTIONS OF MOUNTS ARE DIMENSIONED

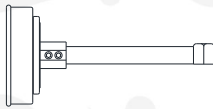

**B10** 6"(H) 12.5"(W)

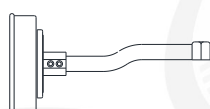

**B101** 6"(H) 13.5"(W)



**B11** 6"(H) 14.5"(W)



**B13** 6"(H) 16.5"(W)



**WM13R** 12"(H) 9.5"(W)

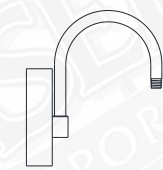

**WM13X** 12"(H) 10.5"(W)

**3/4" WALL MOUNTS**

\*MOUNTS RATED FOR WET LOCATION \* MAXIMUM SECTIONS OF MOUNTS ARE DIMENSIONED



**B12** 6"(H) 15.5"(W)



**B9** 5"(H) 18"(W)

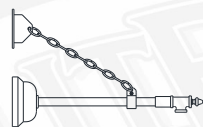

**B9C** 5"(H) 18"(W)  
\*CHAIN HEIGHT TBD BY CUSTOMER



**WM14X** 18"(H) 14"(W)

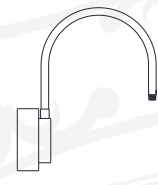

**WM15** 23"(H) 19.5"(W)

**C - MOUNTING OPTIONS (CONTINUED)**

**3/4" WALL MOUNTS**

\*MOUNTS RATED FOR WET LOCATION \* MAXIMUM SECTIONS OF MOUNTS ARE DIMENSIONED

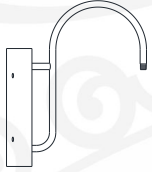

**WM35X** 26"(H) 22"(W)



**WM55X** 19"(H) 27"(W)

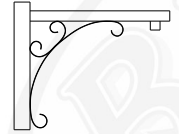

**WM60X** 18"(H) 22"(W)

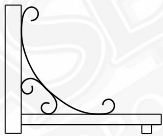

**WM61X** 18"(H) 22"(W)

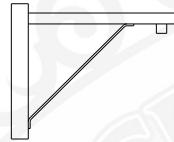

**WM70X** 18"(H) 22"(W)

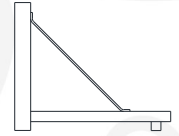

**WM71X** 18"(H) 22"(W)

**STEM MOUNTS**

\*STEMS RATED FOR DAMP LOCATION

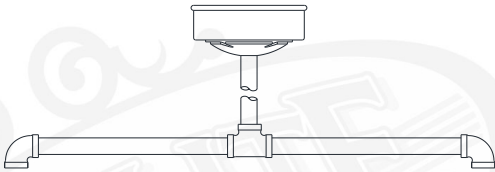

**DP24** DOUBLE PENDANT 20"(H) 24"(W)  
\*DP24 COMES STANDARD WITH LSTC AND ST18



**ST(XX)** STEM- 1/2" NPT

XX = LENGTH OF STEM  
(EXAMPLE - "ST18" = STEM MOUNT 18" LENGTH)  
\*CANOPY NOT INCLUDED, ADD IN SECTION D  
\* 1/4" NPT AND 3/4" NPT AVAILABLE UPON REQUEST



**SC24** SCROLL STEM 33"(H) 26"(W)  
\*SC24 COMES STANDARD WITH LSTC

**CORD MOUNTS**

\*CORDS RATED FOR DRY LOCATION. \*CORD AND CANOPY COME IN THE SAME COLOR.

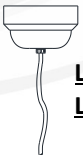

**LBLC** 8' BLACK CORD  
**LWHC** 8' WHITE CORD



**LTCB** 8' BLACK CORD, CABLE, and LOOP  
**LTCW** 8' WHITE CORD, CABLE, and LOOP



**LTCHB** 8' BLACK CORD, 3' CHAIN, and LOOP  
**LTCW** 8' WHITE CORD, 3' CHAIN, and LOOP

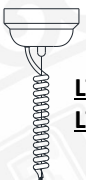

**LTLB** 8' BLACK TELEPHONE CORD AND CABLE  
**LTLW** 8' WHITE TELEPHONE CORD AND CABLE

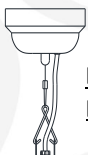

**LRCB** 8' BLACK CORD, CABLE, and LOOP  
**LRCW** 8' WHITE CORD, CABLE, and LOOP



**LRCHB** 8' BLACK CORD, 3' CHAIN, and LOOP  
**LRCHW** 8' WHITE CORD, 3' CHAIN, and LOOP



**LFBH** 8' BLACK CORD WITH FLAT HUB  
**LFWH** 8' WHITE CORD WITH FLAT HUB



**LCBLC** 8' BLACK CORD and CABLE  
**LCWHC** 8' WHITE CORD and CABLE



**LCHB** 8' BLACK CORD, 3' CHAIN, and LOOP  
**LCHW** 8' WHITE CORD, 3' CHAIN, and LOOP  
\* Loop may vary due to shade style

**NOTES: CANOPY SIZES**  
\*ALL LED CANOPIES MAY VARY IN SIZE ACCORDING TO THE WATTAGE THAT IS CHOSEN. HIGHER WATTAGE TAKES A LARGER CANOPY.  
5.5" CANOPY - UP TO 25W  
6.5" CANOPY - UP TO 50W  
10" CANOPY - UP TO 100W



## I – GLASS OPTIONS

NOTE : GLASS IS HEAT RESISTANCE BOROSILICATE. \*TEMPERD GLASS AVAILABLE UPON REQUEST. CONTACT YOUR LOCAL SALES REPRESENTATIVE FOR INFORMATION OR CALL FACTORY FOR QUESTIONS.



**CL3** 3" CLEAR GLASS    **PR3** 3" PRISMATIC GLASS    **RE3** 3" RED GLASS    **BL3** 3" BLUE GLASS  
**CL4** 4" CLEAR GLASS    **PR4** 4" PRISMATIC GLASS    **RE4** 4" RED GLASS    **BL4** 4" BLUE GLASS



**FR3** 3" FROSTED GLASS    **AH3** 3" AMBER HYDE GLASS    **GR3** 3" GREEN GLASS  
**FR4** 4" FROSTED GLASS    **AH4** 4" AMBER HYDE GLASS    **GR4** 4" GREEN GLASS

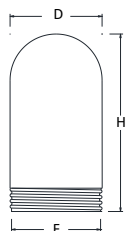

GLASS – DIMENSIONS	
3" GLASS	
Diameter	3.34"
Height	6.93"
Fitter	3.29"
4" GLASS	
Diameter	4.34"
Height	8.37"
Fitter	4.29"

GLASS – MAX WATTAGE	
3" GLASS	– 100W INC / LED25W
4" GLASS	– 200W INC / LED25W



**BA** 6" OPAL BALL (100W INC MAX/LED12W)    **BAX** 9" CLEAR GLOBE (150W INC MAX/LED25W)    **FN** 8" CLEAR TEXTURED GLOBE (150W INC MAX/LED25W)  
**BAF** 9" FROSTED GLOBE (200W INC MAX/LED25W)  
**BA7** 7" CLEAR GLOBE    **PR8** 8" PRISMATIC    **OC** 8" OPAL TAPERED GLOBE (60W INC MAX/LED25W)  
**BA7F** 7" FROSTED GLOBE (100W INC MAX/LED25W)    **PR8F** 8" PRISMATIC FROSTED (200W INC MAX/LED45W)

## J – ACCESSORIES

NOTE : DUE TO THE SIZE OF THE LED BUBBLE, WATTAGE RESTRICTIONS APPLY TO WIRE AND CAST GUARDS - WG-1 & GU-1 LED 12W MAX - WG-2 & GU-2 LED 30W MAX

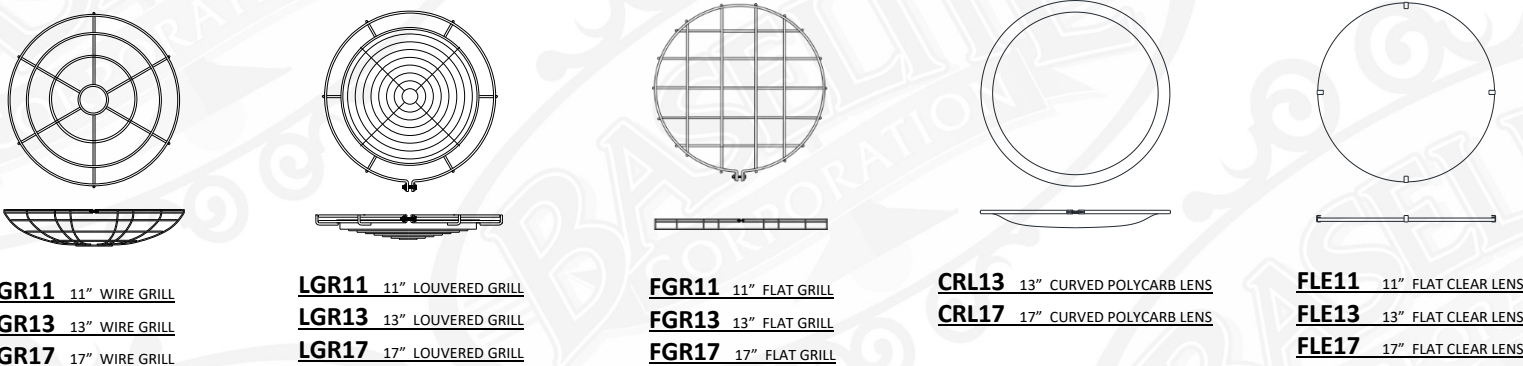

**GR11** 11" WIRE GRILL    **LGR11** 11" LOUVERED GRILL    **FGR11** 11" FLAT GRILL    **CRL13** 13" CURVED POLYCARB LENS    **FLE11** 11" FLAT CLEAR LENS  
**GR13** 13" WIRE GRILL    **LGR13** 13" LOUVERED GRILL    **FGR13** 13" FLAT GRILL    **CRL17** 17" CURVED POLYCARB LENS    **FLE13** 13" FLAT CLEAR LENS  
**GR17** 17" WIRE GRILL    **LGR17** 17" LOUVERED GRILL    **FGR17** 17" FLAT GRILL    **FLE17** 17" FLAT CLEAR LENS

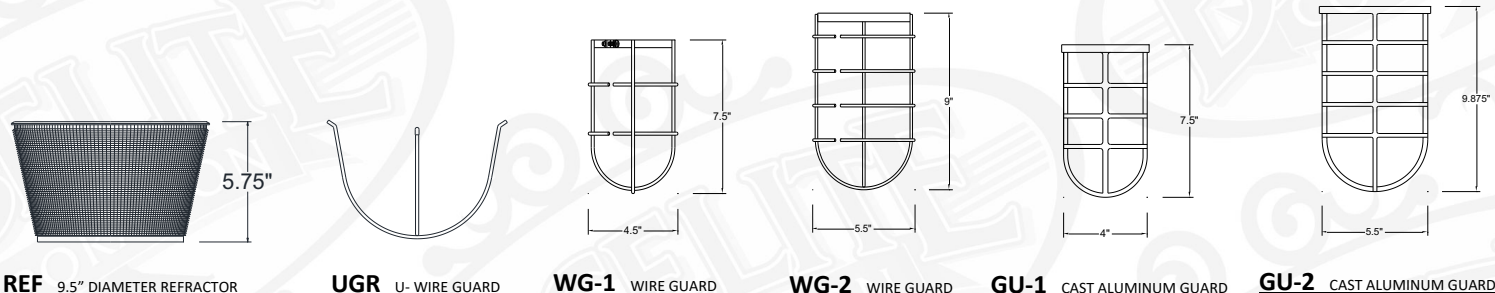

**REF** 9.5" DIAMETER REFRACTOR    **UGR** U- WIRE GUARD    **WG-1** WIRE GUARD    **WG-2** WIRE GUARD    **GU-1** CAST ALUMINUM GUARD    **GU-2** CAST ALUMINUM GUARD