

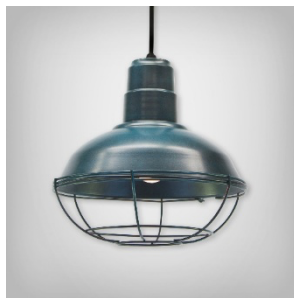

BASELITE – WAREHOUSE SHADE – LED – SPEC SHEET

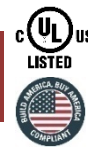

PROJECT NAME: _____ PROJECT TYPE: _____

NOTES: **BABA COMPLIANT**

*FOR A COMPLETE MODEL NUMBER, MAKE A SELECTION FROM THE DROP DOWNS BELOW. SKIP SECTIONS THAT DO NOT APPLY.

MODEL

EXAMPLE: W512 41 E16 SQ ½" 43 50W 3K LDM120 PR3 GR12 44

A - SHADES

WAREHOUSE

- W508 - 12W (MAX)
- W512 - 25W (MAX)
- W514 - 35W (MAX)
- WC514 - 35W (MAX)
- W516 - 50W (MAX)
- W516X - 50W (MAX)
- W5167 - 50W (MAX)
- W518 - 80W (MAX)
- W520 - 80W (MAX)
- W5206 - 80W (MAX)
- W524 - 100W (MAX)
- W527 - 100W (MAX)

B - FINISH OPTIONS

(SEE WEBSITE FOR SWATCH COLORS)
(*SEE NOTES FOR LIMITATIONS*)

- 14, 15, 16, 17, 18, 19, 19P, 20, 20P, 20PB, 20SB, 21, 21P, 22, 22P, 23, 23P, 38, 39, 40, 41, 41.5, 42, 43, 44, 45, 46, 48, 49, 50, 51, 52, 53, 54, 55, 57, 58, 59, 60, 61, 62, 63, 64, 65, 66, 70, 71, 72, 73, 74, 75, 76, 77, 78, 79, 80, 81, 82, 83, 84, 85, 86, 87, 88, 89, 90, 91, 92, 93, 94, 95, 96, 97, 98, 99, 100

C - MOUNTING OPTIONS

½" ARM EXTENSIONS

- E1, E2, E3, E4, B1, E16, E17, E18, E26, E27

¾" ARM EXTENSIONS

- E3A, E4A, E5, E6, E7, E8, E9, E10, E11, E12, E13, B15, B15S, E19, E20, E21, E25

E14 - CREATE YOUR OWN

(BASELITE WILL TAKE YOUR SKETCH AND FABRICATE A CUSTOM ARM EXTENSION TO MEET YOUR NEEDS).

½" WALL MOUNT

- B13, WM13R, WM13X, B10, B11, B101

¾" WALL MOUNT

- B9, B9C, B12, WM10, WM11, WM14X, WM15, WM35X, WM55X, WM60X, WM61X WM70X, WM71X

LED CORD MOUNT

- LBLC, LWHC, LTCB, LTCW, LTCHB, LTCHW, LTLB, LTLW, LTLB, LTLW, LRCB, LRCW, LRCHB, LRCHW, LFHB, LFHW, LHBL, LHWHC, LCBL, LCWHC, LCHB, LCHW

STEM MOUNT

- ST6, ST12, ST18, ST24, ST36, ST48, STXX

D - MOUNTING ADD-ONS

LED ADD-ONS

LWTM, LSLC, LSTC

UNIVERSAL ADD-ONS

SQ ½", SQ ¾", FH ½", FH ¾", TRB ½", TRB ¾", SWL, LGSWL, CNK, INB, RINB

E - MOUNTING COLOR

SEE SECTION "B" FOR COLOR OPTIONS.

F - LIGHT SOURCE

(SEE PAGE 4 FOR WATTAGE LIMITATIONS)

LIGHT EMITTED DIODE (LED)

LED10WF, LED12W, LED25W, LED35W, LED50W, LED80W, LED100W

*NOTE - MAX WATTAGE IS LISTED NEXT TO THE SHADE MODEL NUMBER IN SECTION "A". ALL WATTAGES BELOW THAT ARE ALSO AVAILABLE FOR THE SAME MODEL NUMBER.

G - LED COLOR TEMP

- 27K - 2700 KELVIN
- 3K - 3000 KELVIN
- 35K - 3500 KELVIN
- 4K - 4000 KELVIN
- 5K - 5000 KELVIN

H - ELECTRICAL OPTION

(SEE PAGE 4 FOR DIMMING OPTION SPECIFICATIONS)

- LDM120
- LDM0-10

I - GLASS OPTIONS

(BOROSILICATE HEAT RESISTANCE GLASS)

- CL3, CL4, BL3, BL4, RE3, RE4, GR3, GR4, AH3, AH4, FR3, FR4, PR3, PR4, BA, BAX, BAF, PR8, PR8F, FN, OC

J - ACCESSORIES

- GR8, GR12, GR14, GR16, GR18, GR20, GR24, GR27, REF, UGR, LGR8, LGR12, LGR14, LGR16, LGR18, LGR20, LGR24, LGR27, CRL8, CRL12, CRL14, CRL16, CRL18, CRL20, FLE12, FLE14, FLE16, FLE18, FLE20, FLE24, FLE27, FGR8, FGR12, FGR14, FGR16, FGR18, FGR20, FGR24, FGR27, GU-1, GU-2, WG-1, WG-2

K - ACCESSORY COLOR

SEE SECTION "B" FOR COLOR OPTIONS.

NOTES

- (1). FINISH OPTIONS 75,76, 77, 83, 84, 88, 93 AND 98 ARE APPLIED BY HAND. THESE FINISHES WILL VARY IN CONSISTENCY.
- (2). FINISH OPTIONS 38, 39, 40, 49, 54, 57, 58, 61, 62, 63, 70, 71, 72, 73, 78, 83, 84, 88, 92, 93, 98 ONLY AVAILABLE INSIDE AND OUT OF FIXTURE. OTHER FINISHES ARE WHITE INSIDE.
- (3). FINISH OPTIONS FOR SHADES ≤ 10" IN DIAMETER ARE THE SAME INSIDE AND OUT OF FIXTURE. SHADES > 10" IN DIAMETER ARE WHITE ON THE INSIDE.
- (4). FINISH OPTIONS 61, 62, 70, 71, 72, 73 ARE FINISHED WITH A SUPERCHROME ON THE INSIDE FOR ALL LED LIGHT SOURCE OPTIONS.
- (5). COLOR CORDS ARE NOT APPLICABLE FOR LED OPTIONS.
*ALL ARMS COME WITH A CAST BACKPLATE (CB1/2", CB3/4", LWTM, CFWTM, ECT.).
*ACCORDING TO THE LIGHT SOURCE THE BACKPLATE MAY VARY IN SIZE. (EXAMPLE: LED LIGHT SOURCE WILL HAVE A DEEPER BACKPLATE TO HOUSE THE DRIVER.).
*ALL FIXTURES MOUNT TO A RECESSED 4-O JUNCTION BOX.
*FIXTURE DIMENSIONS MAY VARY ± 0.25.
*CORD AND CANOPY COME IN THE SAME COLOR.

SHADE DIMENSIONS

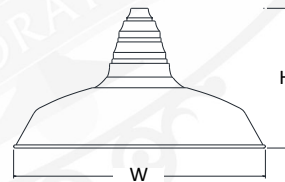

W5206 H-11" W-20"



W516X H-10.5" W-16.5"

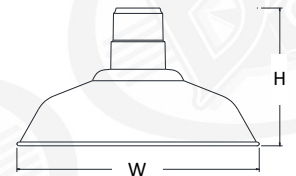

W508 H-6" W-8"

W512 H-8" W-12"

W514 H-9" W-14"

W516 H-9" W-16"

W518 H-9" W-18"

W520 H-10" W-20"

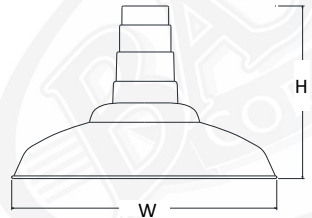

W524 H-16" W-24"

W527 H-16" W-27"

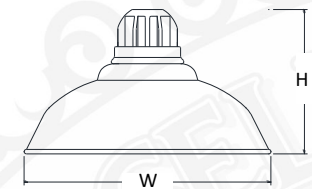

WC514 H-8" W-14"



W5167 H-7.5" W-16"



C - MOUNTING OPTIONS

1/2" ARM EXTENSIONS

*ARMS RATED FOR WET LOCATION * MAXIMUM SECTIONS OF ARMS ARE DIMENSIONED

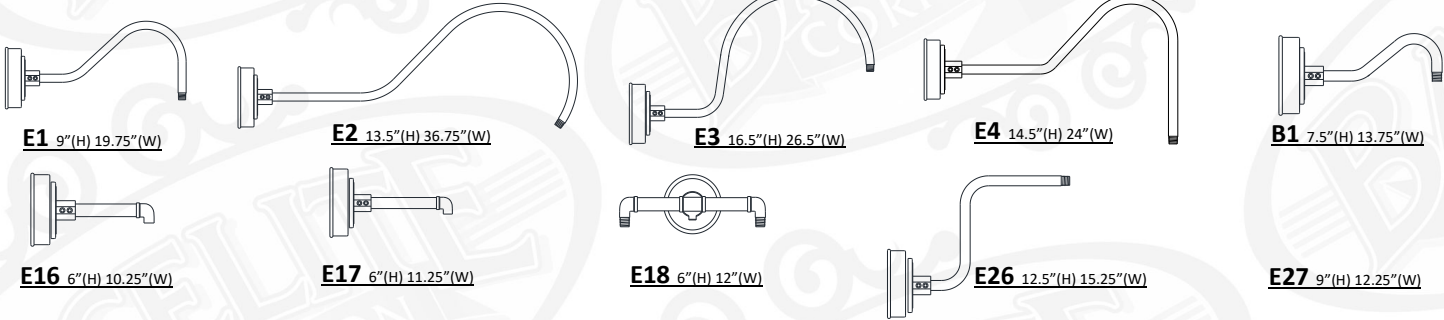

3/4" ARM EXTENSIONS

*ARMS RATED FOR WET LOCATION * MAXIMUM SECTIONS OF ARMS ARE DIMENSIONED

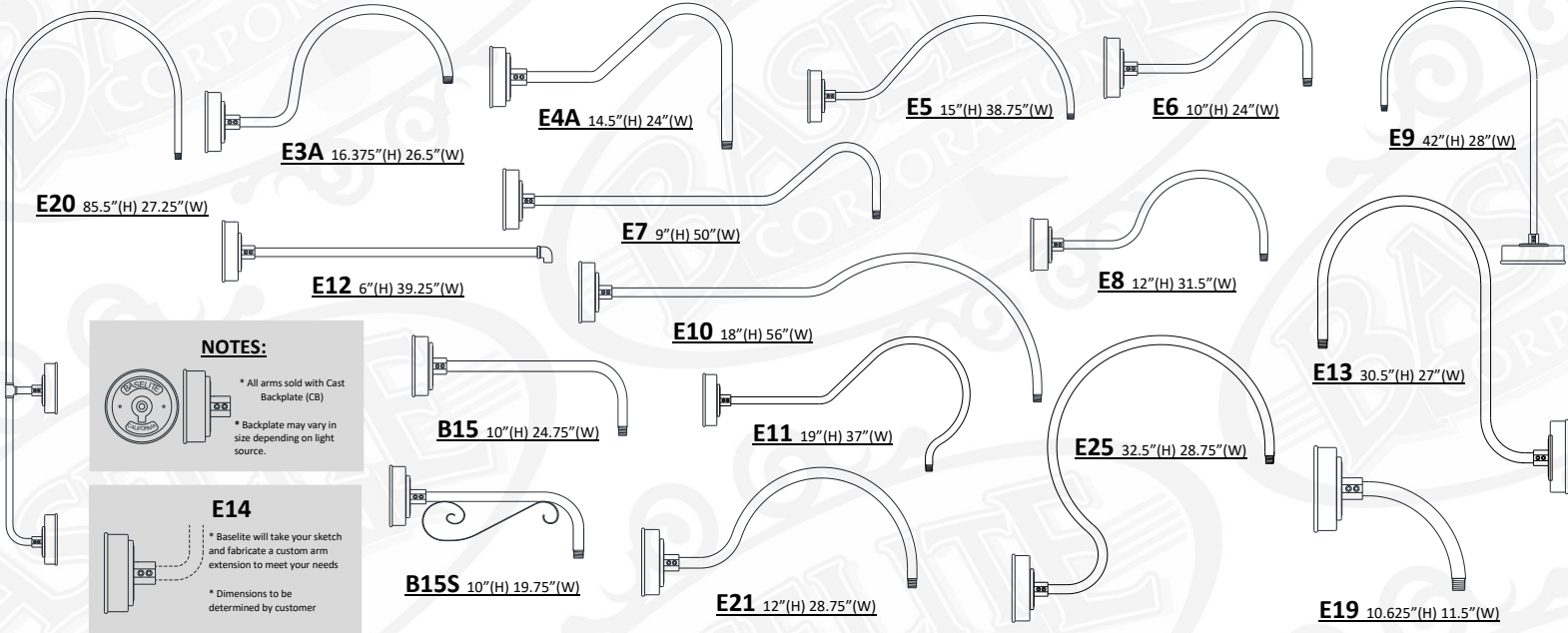

1/2" WALL MOUNTS

*MOUNTS RATED FOR WET LOCATION * MAXIMUM SECTIONS OF MOUNTS ARE DIMENSIONED

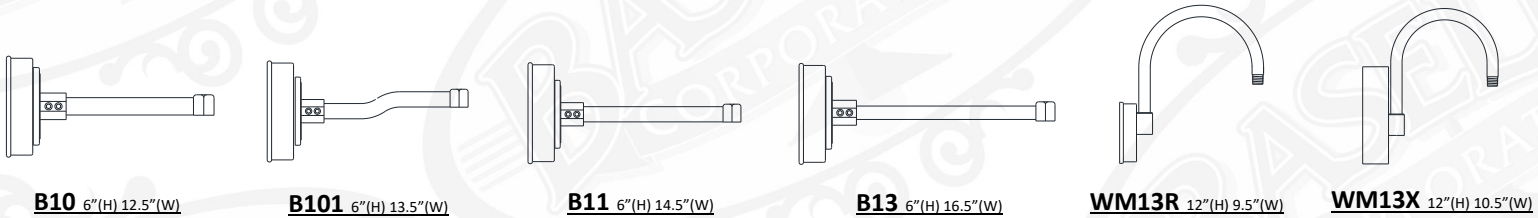

3/4" WALL MOUNTS

*MOUNTS RATED FOR WET LOCATION * MAXIMUM SECTIONS OF MOUNTS ARE DIMENSIONED

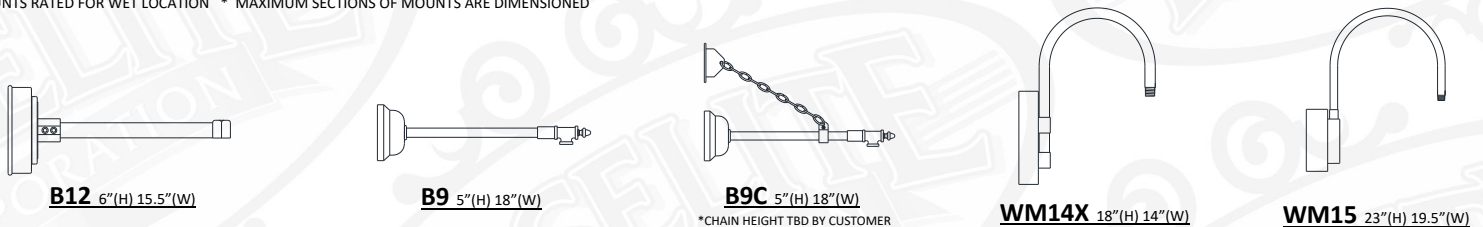



C - MOUNTING OPTIONS (CONTINUED)

3/4" WALL MOUNTS

*MOUNTS RATED FOR WET LOCATION * MAXIMUM SECTIONS OF MOUNTS ARE DIMENSIONED

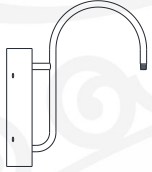

WM35X 26"(H) 22"(W)



WM55X 19"(H) 27"(W)

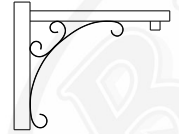

WM60X 18"(H) 22"(W)

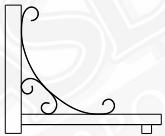

WM61X 18"(H) 22"(W)

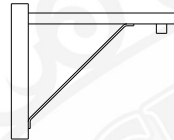

WM70X 18"(H) 22"(W)

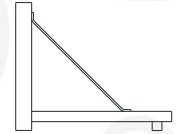

WM71X 18"(H) 22"(W)

STEM MOUNTS

*STEMS RATED FOR DAMP LOCATION

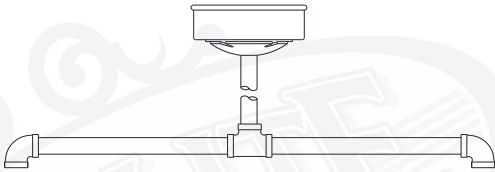

DP24 DOUBLE PENDANT 20"(H) 24"(W)
*DP24 COMES STANDARD WITH LSTC AND ST18



ST(XX) STEM- 1/2" NPT
XX = LENGTH OF STEM
(EXAMPLE - "ST18" = STEM MOUNT 18" LENGTH)
*CANOPY NOT INCLUDED, ADD IN SECTION D
* 1/4" NPT AND 3/4" NPT AVAILABLE UPON REQUEST



SC24 SCROLL STEM 33"(H) 26"(W)
*SC24 COMES STANDARD WITH LSTC

LED - CORD MOUNTS

*CORDS RATED FOR DRY LOCATION *CORD AND CANOPY COME IN THE SAME COLOR.



LBLC 8' BLACK CORD
LWHC 8' WHITE CORD

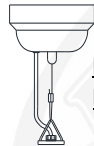

LTCB 8' BLACK CORD, CABLE, and LOOP
LTCW 8' WHITE CORD, CABLE, and LOOP



LTCHB 8' BLACK CORD, 3' CHAIN, and LOOP
LTCHW 8' WHITE CORD, 3' CHAIN, and LOOP



LTLB 8' BLACK TELEPHONE CORD AND CABLE
LTLW 8' WHITE TELEPHONE CORD AND CABLE



LRCB 8' BLACK CORD, CABLE, and LOOP
LRCW 8' WHITE CORD, CABLE, and LOOP



LRCHB 8' BLACK CORD, 3' CHAIN, and LOOP
LRCHW 8' WHITE CORD, 3' CHAIN, and LOOP



LFHB 8' BLACK CORD WITH FLAT HUB
LFHW 8' WHITE CORD WITH FLAT HUB



LCBLC 8' BLACK CORD and CABLE
LCWHC 8' WHITE CORD and CABLE



LCHB 8' BLACK CORD, 3' CHAIN, and LOOP
LCHW 8' WHITE CORD, 3' CHAIN, and LOOP
* Loop may vary due to shade style



NOTES: CANOPY SIZES

* ALL LED CANOPIES MAY VARY IN SIZE ACCORDING TO THE WATTAGE THAT IS CHOSEN. HIGHER WATTAGE TAKES A LARGER CANOPY.

5.5" CANOPY - UP TO 25W
6.5" CANOPY - UP TO 50W
10" CANOPY - UP TO 100W

I – GLASS OPTIONS

NOTE : GLASS IS HEAT RESISTANCE BOROSILICATE. *TEMPERD GLASS AVAILABLE UPON REQUEST. CONTACT YOUR LOCAL SALES REPRESENTATIVE FOR INFORMATION OR CALL FACTORY FOR QUESTIONS.



CL3 3" CLEAR GLASS
CL4 4" CLEAR GLASS



PR3 3" PRISMATIC GLASS
PR4 4" PRISMATIC GLASS



RE3 3" RED GLASS
RE4 4" RED GLASS



BL3 3" BLUE GLASS
BL4 4" BLUE GLASS



FR3 3" FROSTED GLASS
FR4 4" FROSTED GLASS



AH3 3" AMBER HYDE GLASS
AH4 4" AMBER HYDE GLASS



GR3 3" GREEN GLASS
GR4 4" GREEN GLASS

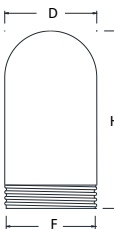

GLASS – DIMENSIONS	
3" GLASS	
Diameter	3.34"
Height	6.93"
Fitter	3.29"
4" GLASS	
Diameter	4.34"
Height	8.37"
Fitter	4.29"

GLASS – MAX WATTAGE	
3" GLASS	100W INC / LED25W
4" GLASS	200W INC / LED25W



BA 6" OPAL BALL
(100W INC MAX/LED12W)



BAX 9" CLEAR GLOBE
BAF 9" FROSTED GLOBE
(200W INC MAX/LED25W)



FN 8" CLEAR TEXTURED GLOBE
(150W INC MAX/LED25W)



BA7 7" CLEAR GLOBE
BA7F 7" FROSTED GLOBE
(100W INC MAX/LED25W)



PR8 8" PRISMATIC
PR8F 8" PRISMATIC FROSTED
(200W INC MAX/LED45W)



OC 8" OPAL TAPERED GLOBE
(60W INC MAX/LED25W)

J – ACCESSORIES

NOTE : DUE TO THE SIZE OF THE LED BUBBLE, WATTAGE RESTRICTIONS APPLY TO WIRE AND CAST GUARDS - WG-1 & GU-1 LED 12W MAX - WG-2 & GU-2 LED 30W MAX

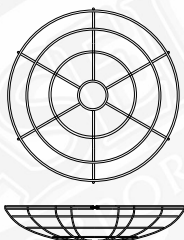

GR8 8" WIRE GRILL
GR12 12" WIRE GRILL
GR14 14" WIRE GRILL
GR16 16" WIRE GRILL
GR18 18" WIRE GRILL
GR20 20" WIRE GRILL
GR24 24" WIRE GRILL
GR27 27" WIRE GRILL

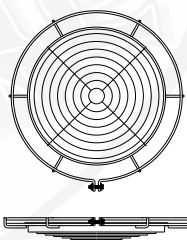

LGR8 8" LOUVERED GRILL
LGR12 12" LOUVERED GRILL
LGR14 14" LOUVERED GRILL
LGR16 16" LOUVERED GRILL
LGR18 18" LOUVERED GRILL
LGR20 20" LOUVERED GRILL
LGR24 24" LOUVERED GRILL
LGR27 27" LOUVERED GRILL

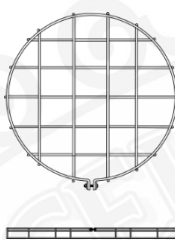

FGR8 8" FLAT GRILL
FGR12 12" FLAT GRILL
FGR14 14" FLAT GRILL
FGR16 16" FLAT GRILL
FGR18 18" FLAT GRILL
FGR20 20" FLAT GRILL
FGR24 24" FLAT GRILL
FGR27 27" FLAT GRILL



CRL8 8" CURVED POLYCARB LENSE
CRL12 12" CURVED POLYCARB LENSE
CRL14 14" CURVED POLYCARB LENSE
CRL16 16" CURVED POLYCARB LENSE
CRL18 18" CURVED POLYCARB LENSE
CRL20 20" CURVED POLYCARB LENSE

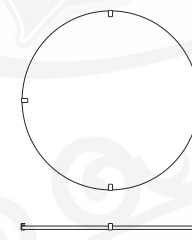

FLE8 8" FLAT CLEAR LENSE
FLE12 12" FLAT CLEAR LENSE
FLE14 14" FLAT CLEAR LENSE
FLE16 16" FLAT CLEAR LENSE
FLE18 18" FLAT CLEAR LENSE
FLE20 20" FLAT CLEAR LENSE
FLE24 24" FLAT CLEAR LENSE
FLE27 27" FLAT CLEAR LENSE

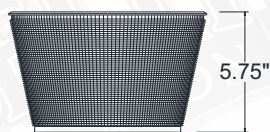

REF 9.5" DIAMETER REFRACTOR



UGR U-WIRE GUARD

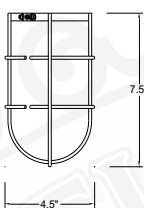

WG-1 WIRE GUARD

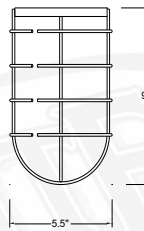

WG-2 WIRE GUARD
Available for shades 12" or higher

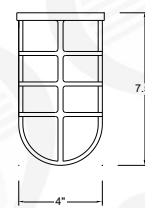

GU-1 CAST ALUMINUM GUARD

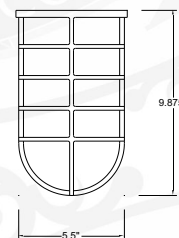

GU-2 CAST ALUMINUM GUARD
Available for shades 12" or higher