

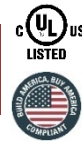

BASELITE – DEEP BOWL – LED – SPECIFICATION SHEET



PROJECT NAME: _____ PROJECT TYPE: _____

NOTES: **BABA COMPLIANT**



*FOR A COMPLETE MODEL NUMBER, MAKE A SELECTION FROM THE DROP DOWNS BELOW. SKIP SECTIONS THAT DO NOT APPLY.

MODEL #											
EXAMPLE:	D616	41	E16	SQ 1/2"	43	50W	3K	LDM120	PR3	GR16	44

A - SHADES

DEEP BOWL

- D610** - 12W (MAX)
- D612** - 12W (MAX)
- D614** - 25W (MAX)
- D616** - 50W (MAX)
- D618** - 80W (MAX)
- D627** - 100W (MAX)

B - FINISH OPTIONS

(SEE WEBSITE FOR SWATCH COLORS)
(*SEE NOTES FOR LIMITATIONS*)

- 14, 15, 16, 17, 18, 19P, 20P, 20PB, 20SB,
- 21P, 22P, 23P, 38, 39, 40, 41, 41.5, 42, 43,
- 44, 45, 46, 48, 49, 50, 51, 52, 53, 54, 55, 57,
- 58, 59, 60, 61, 62, 63, 64, 65, 66, 70, 71, 72,
- 73, 74, 75, 76, 77, 78, 79, 80, 81, 82, 83, 84,
- 85, 86, 87, 88, 89, 90, 91, 92, 93, 94, 95, 96,
- 97, 98, 99, 100, MG.

C – MOUNTING OPTIONS

1/2" ARM EXTENSIONS

E1, E2, E3, E4, B1, E16, E17, E27

3/4" ARM EXTENSIONS

E3A, E4A, E5, E6, E7, E8, E9,
E10, E11, E12, E13, B15, B15S,
E19, E20, E21, E25

E14 - CREATE YOUR OWN

(BASELITE WILL TAKE YOUR SKETCH AND FABRICATE A CUSTOM ARM EXTENSION TO MEET YOUR NEEDS).

1/2" WALL MOUNT

B13, WM13R, WM13X, B10, B11, B101

3/4" WALL MOUNT

B9, B9C, B12, WM10, WM11, WM14X,
WM15, WM35X, WM55X, WM60X,
WM61X WM70X, WM71X

LED CORD MOUNT

LBLC, LWHC, LTCB, LTCW, LTCHB,
LTCHW, LTLB, LTLW, LTLB, LTLW, LRCB,
LRCW, LRCHB, LRCHW, LFHB, LFHW,
LHBLC, LHWHC, LCBLC, LCWHC, LCHB,
LCHW

STEM MOUNT

ST6, ST12, ST18, ST24, ST36, ST48, STXX

D – MOUNTING ADD-ONS

LED ADD-ONS

LWTM, LSLC, LSTC

UNIVERSAL ADD-ONS

SQ 1/2", SQ 3/4", FH 1/2", FH 3/4", TRB 1/2", TRB 3/4",
SWL, LGSWL, CNK, INB, RINB

E – MOUNTING COLOR

SEE SECTION "B" FOR COLOR OPTIONS.

F – LIGHT SOURCE

(SEE PAGE 4 FOR WATTAGE LIMITATIONS)

LIGHT EMITTED DIODE (LED)

10WF, 12W, 25W, 35W, 50W, 80W, 100W

*NOTE – MAX WATTAGE IS LISTED NEXT TO THE SHADE MODEL NUMBER IN SECTION "A". ALL WATTAGES BELOW THAT ARE ALSO AVAILABLE FOR THE SAME MODEL NUMBER.

G – LED COLOR TEMP

27K – 2700 KELVIN

3K – 3000 KELVIN

35K – 3500 KELVIN

4K – 4000 KELVIN

5K – 5000 KELVIN

H – ELECTRICAL OPTION

(SEE PAGE 4 FOR DIMMING OPTION SPECIFICATIONS)

LDM120

LDM0-10

I – GLASS OPTIONS

CL3, CL4, BL3, BL4, RE3, RE4, GR3, GR4,
AH3, AH4, FR3, FR4, PR3, PR4, BA, BAX,
BAF, PR8, PR8F, FN, OC

J – ACCESSORIES

GR10, GR12, GR14, GR16, GR18, GR27, REF,
UGR, LGR10, LGR12, LGR14, LGR16, LGR18,
LGR27, CRL10, CRL12, CRL14, CRL16, CRL18,
FLE10, FLE12, FLE14, FLE16, FLE18, FLE27,
FGR10, FGR12, FGR14, FGR16, FGR18, FGR27,
GU-1, GU-2, WG-1, WG-2

K – ACCESSORY COLOR

SEE SECTION "B" FOR COLOR OPTIONS.

NOTES

- (1). FINISH OPTIONS 75,76, 77, 83, 84, 88, 93 AND 98 ARE APPLIED BY HAND. THESE FINISHES WILL VARY IN CONSISTENCY.
- (2). FINISH OPTIONS 38, 39, 40, 49, 54, 57, 58, 61, 62, 63, 70, 71, 72, 73, 78, 83, 84, 88, 92, 93, 98 ONLY AVAILABLE INSIDE AND OUT OF FIXTURE. OTHER FINISHES ARE WHITE INSIDE.
- (3). FINISH OPTIONS FOR SHADES ≤ 10" IN DIAMETER ARE THE SAME INSIDE AND OUT OF FIXTURE. SHADES > 10" IN DIAMETER ARE WHITE ON THE INSIDE.
- (4). FINISH OPTIONS 61, 62, 70, 71, 72, 73 ARE FINISHED WITH A SUPERCHROME ON THE INSIDE FOR ALL LED LIGHT SOURCE OPTIONS.
- (5). COLOR CORDS ARE NOT APPLICABLE FOR LED OPTIONS.
*ALL ARMS COME WITH A CAST BACKPLATE (CB1/2", CB3/4", LWTM, CFWTM, ECT.).
*ACCORDING TO THE LIGHT SOURCE THE BACKPLATE MAY VARY IN SIZE. (EXAMPLE: LED LIGHT SOURCE WILL HAVE A DEEPER BACKPLATE TO HOUSE THE DRIVER.).
*ALL FIXTURES MOUNT TO A RECESSED 4-O JUNCTION BOX.
*FIXTURE DIMENSIONS MAY VARY ± 0.25.
*CORD AND CANOPY COME IN THE SAME COLOR.

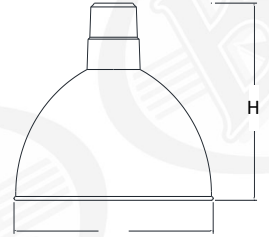

D610 H-10" W-10"

D612 H-10.5" W-12"

D614 H-13" W-14"

D616 H-14" W-16"

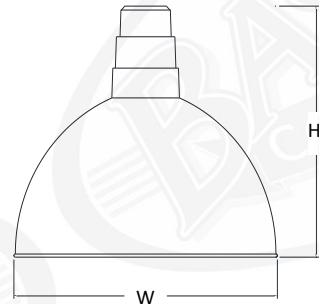

D618 H-16" W-18"

D627 H-17" W-27"



C - MOUNTING OPTIONS

1/2" ARM EXTENSIONS

*ARMS RATED FOR WET LOCATION * MAXIMUM SECTIONS OF ARMS ARE DIMENSIONED

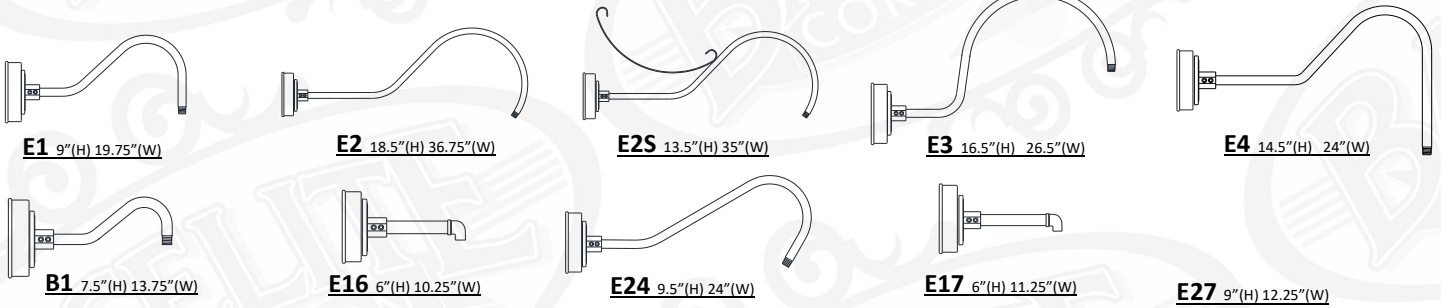

3/4" ARM EXTENSIONS

*ARMS RATED FOR WET LOCATION * MAXIMUM SECTIONS OF ARMS ARE DIMENSIONED

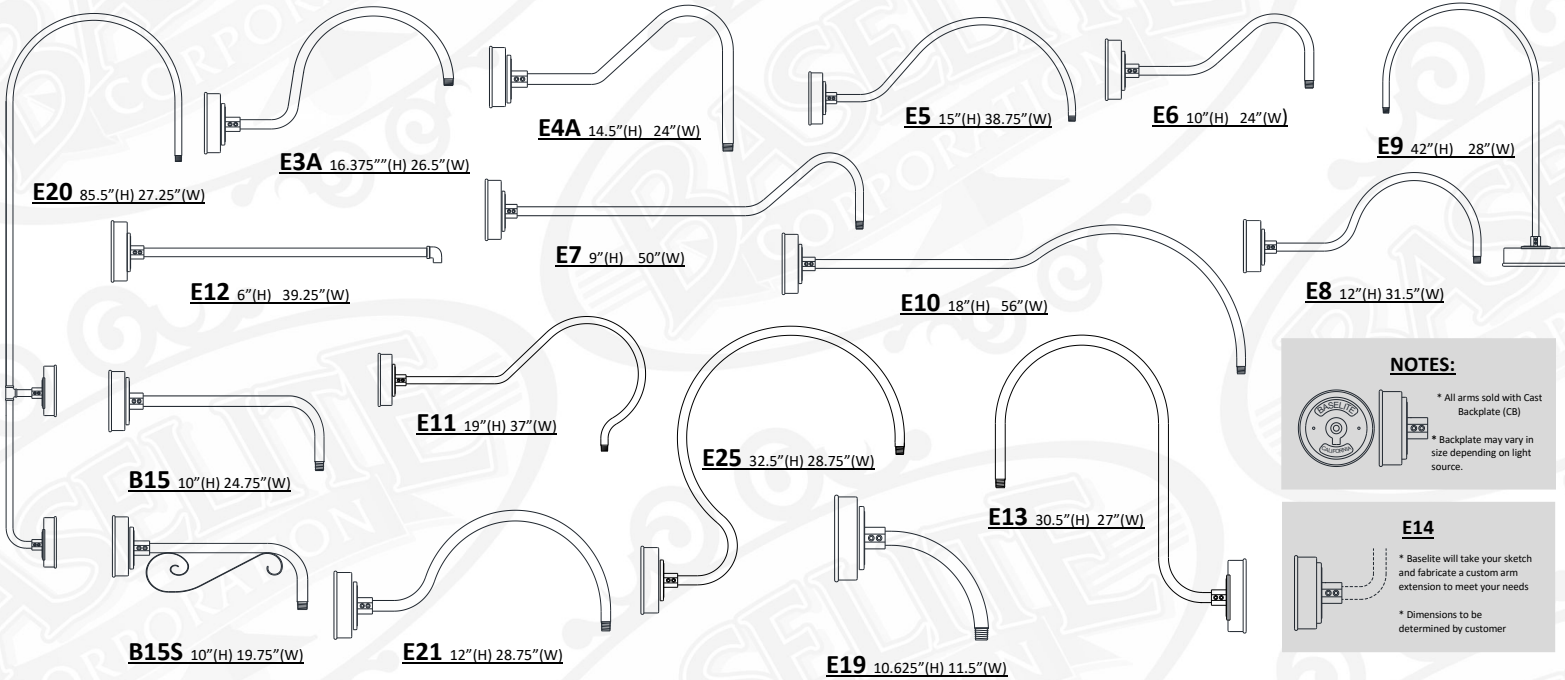

NOTES:

* All arms sold with Cast Backplate (CB)
* Backplate may vary in size depending on light source.

E14

* Baselite will take your sketch and fabricate a custom arm extension to meet your needs
* Dimensions to be determined by customer

1/2" WALL MOUNTS

*MOUNTS RATED FOR WET LOCATION * MAXIMUM SECTIONS OF MOUNTS ARE DIMENSIONED

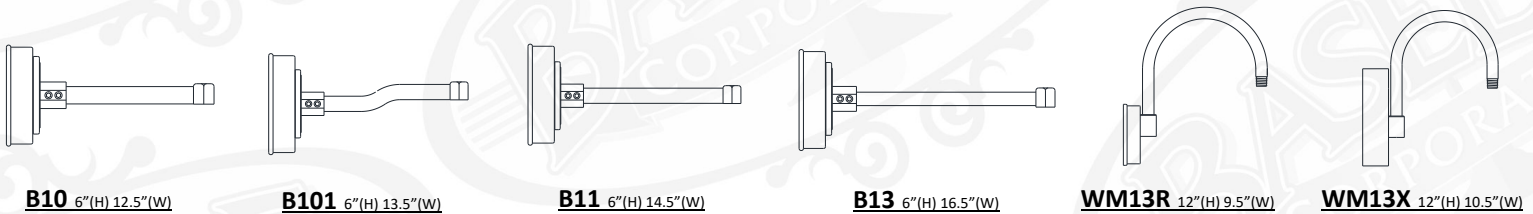

3/4" WALL MOUNTS

*MOUNTS RATED FOR WET LOCATION * MAXIMUM SECTIONS OF MOUNTS ARE DIMENSIONED

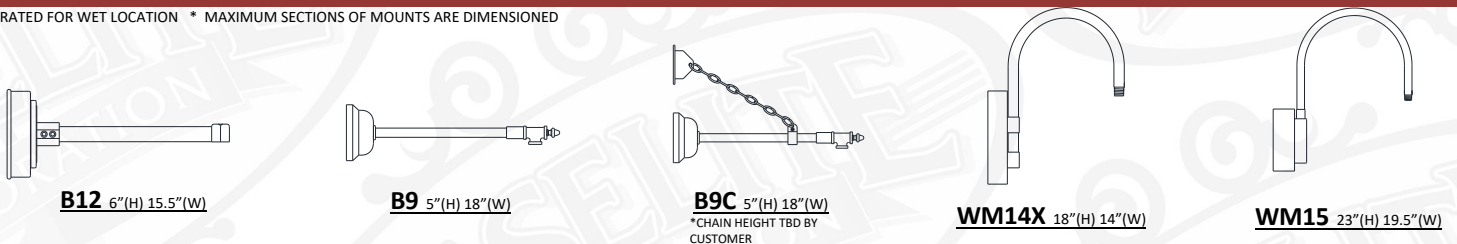



C - MOUNTING OPTIONS (CONTINUED)

3/4" WALL MOUNTS

*MOUNTS RATED FOR WET LOCATION * MAXIMUM SECTIONS OF MOUNTS ARE DIMENSIONED



WM35X 26"(H) 22"(W)



WM55X 19"(H) 27"(W)

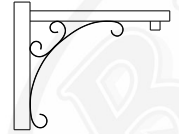

WM60X 18"(H) 22"(W)

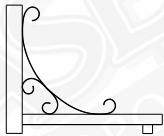

WM61X 18"(H) 22"(W)

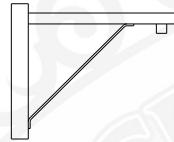

WM70X 18"(H) 22"(W)

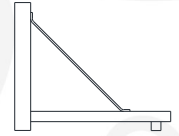

WM71X 18"(H) 22"(W)

STEM MOUNTS

*STEMS RATED FOR DAMP LOCATION

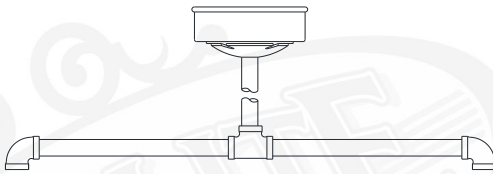

DP24 DOUBLE PENDANT 20"(H) 24"(W)
*DP24 COMES STANDARD WITH LSTC AND ST18



ST(XX) STEM- 1/2" NPT
XX = LENGTH OF STEM
(EXAMPLE - "ST18" = STEM MOUNT 18" LENGTH)
*CANOPY NOT INCLUDED, ADD IN SECTION D
* 1/4" NPT AND 3/4" NPT AVAILABLE UPON REQUEST

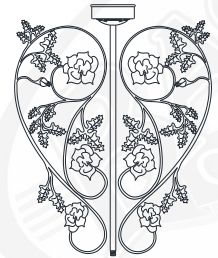

SC24 SCROLL STEM 33"(H) 26"(W)
*SC24 COMES STANDARD WITH LSTC

CORD MOUNTS

*CORDS RATED FOR DRY LOCATION *CORD AND CANOPY COME IN THE SAME COLOR.



LBLC 8' BLACK CORD
LWHC 8' WHITE CORD



LTCB 8' BLACK CORD, CABLE, and LOOP
LTCW 8' WHITE CORD, CABLE, and LOOP



LTCHB 8' BLACK CORD, 3' CHAIN, and LOOP
LTCHW 8' WHITE CORD, 3' CHAIN, and LOOP



LTLB 8' BLACK TELEPHONE CORD AND CABLE
LTLW 8' WHITE TELEPHONE CORD AND CABLE



LRCB 8' BLACK CORD, CABLE, and LOOP
LRCW 8' WHITE CORD, CABLE, and LOOP



LRCHB 8' BLACK CORD, 3' CHAIN, and LOOP
LRCHW 8' WHITE CORD, 3' CHAIN, and LOOP



LFBH 8' BLACK CORD WITH FLAT HUB
LFWH 8' WHITE CORD WITH FLAT HUB



LCBLC 8' BLACK CORD and CABLE
LCWHC 8' WHITE CORD and CABLE



LCHB 8' BLACK CORD, 3' CHAIN, and LOOP
LCHW 8' WHITE CORD, 3' CHAIN, and LOOP
* Loop may vary due to shade style



NOTES: CANOPY SIZES

*ALL LED CANOPIES MAY VARY IN SIZE ACCORDING TO THE WATTAGE THAT IS CHOSEN. HIGHER WATTAGE TAKES A LARGER CANOPY.

5.5" CANOPY - UP TO 25W
6.5" CANOPY - UP TO 50W
10" CANOPY - UP TO 100W



I – GLASS OPTIONS

NOTE : GLASS IS HEAT REISSTANCE BOROSILICATE. *TEMPERD GLASS AVAILABLE UPON REQUEST. CONTACTN YOUR LOCAL SALES REPRESENTATIVE FOR INFORMATION OR CALL FACTORY FOR QUESTIONS.



CL3 3" CLEAR GLASS
CL4 4" CLEAR GLASS
PR3 3" PRISMATIC GLASS
PR4 4" PRISMATIC GLASS
RE3 3" RED GLASS
RE4 4" RED GLASS
BL3 3" BLUE GLASS
BL4 4" BLUE GLASS
FR3 3" FROSTED GLASS
FR4 4" FROSTED GLASS
AH3 3" AMBER HYDE GLASS
AH4 4" AMBER HYDE GLASS
GR3 3" GREEN GLASS
GR4 4" GREEN GLASS

GLASS – DIMENSIONS	
3" GLASS	
Diameter	3.34"
Height	6.93"
Fitter	3.29"
4" GLASS	
Diameter	4.34"
Height	8.37"
Fitter	4.29"

GLASS – MAX WATTAGE	
3" GLASS	– 100W INC / LED25W
4" GLASS	– 200W INC / LED25W



BA 6" OPAL BALL
(100W INC MAX/LED12W)
BAX 9" CLEAR GLOBE
BAF 9" FROSTED GLOBE
(200W INC MAX/LED25W)
FN 8" CLEAR TEXTURED GLOBE
(150W INC MAX/LED25W)
BA7 7" CLEAR GLOBE
BA7F 7" FROSTED GLOBE
(100W INC MAX/LED25W)
PR8 8" PRISMATIC
PR8F 8" PRISMATIC FROSTED
(200W INC MAX/LED45W)
OC 8" OPAL TAPERED GLOBE
(60W INC MAX/LED25W)

J – ACCESSORIES

NOTE : DUE TO THE SIZE OF THE LED BUBBLE, WATTAGE RESTRICTIONS APPLY TO WIRE AND CAST GUARDS - WG-1 & GU-1 LED 12W MAX - WG-2 & GU-2 LED 30W MAX

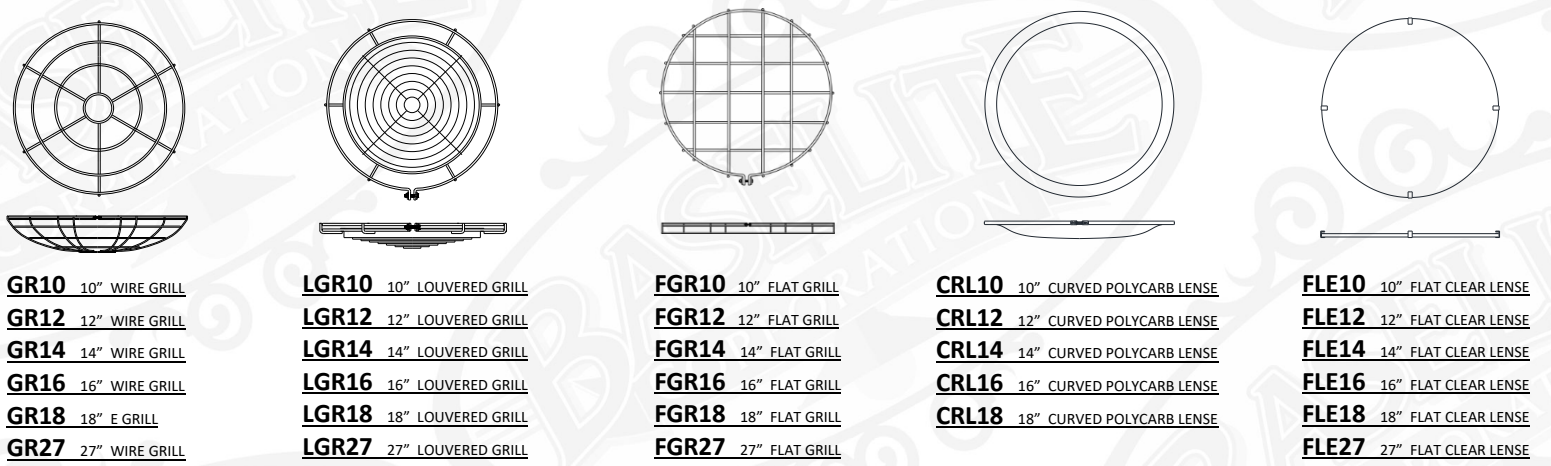

GR10 10" WIRE GRILL
GR12 12" WIRE GRILL
GR14 14" WIRE GRILL
GR16 16" WIRE GRILL
GR18 18" E-GRILL
GR27 27" WIRE GRILL
LGR10 10" LOUVERED GRILL
LGR12 12" LOUVERED GRILL
LGR14 14" LOUVERED GRILL
LGR16 16" LOUVERED GRILL
LGR18 18" LOUVERED GRILL
LGR27 27" LOUVERED GRILL
FGR10 10" FLAT GRILL
FGR12 12" FLAT GRILL
FGR14 14" FLAT GRILL
FGR16 16" FLAT GRILL
FGR18 18" FLAT GRILL
FGR27 27" FLAT GRILL
CRL10 10" CURVED POLYCARB LENSE
CRL12 12" CURVED POLYCARB LENSE
CRL14 14" CURVED POLYCARB LENSE
CRL16 16" CURVED POLYCARB LENSE
CRL18 18" CURVED POLYCARB LENSE
FLE10 10" FLAT CLEAR LENSE
FLE12 12" FLAT CLEAR LENSE
FLE14 14" FLAT CLEAR LENSE
FLE16 16" FLAT CLEAR LENSE
FLE18 18" FLAT CLEAR LENSE
FLE27 27" FLAT CLEAR LENSE

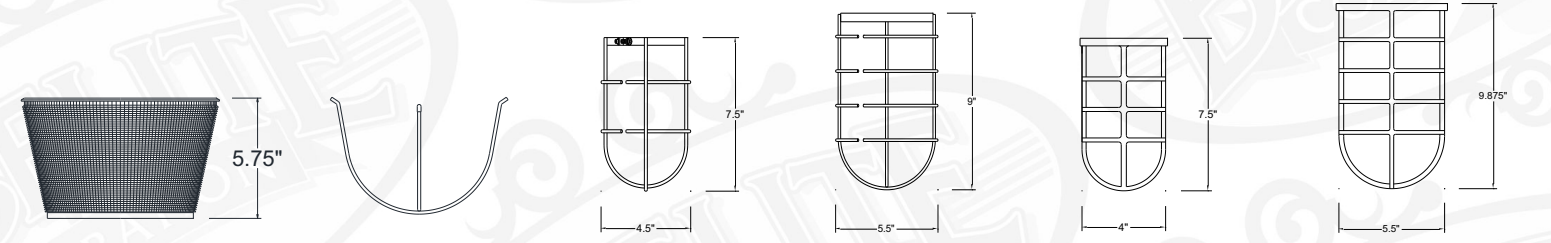

REF 9.5" DIAMETER REFRACTOR
UGR U WIRE GRILL
WG-1 WIRE GUARD
WG-2 WIRE GUARD
Available for shades 12" or higher
GU-1 CAST ALUMINUM GUARD
GU-2 CAST ALUMINUM GUARD
Available for shades 12" or higher