



BASELITE – E – HE – LED – SPECIFICATION SHEET



PROJECT NAME: _____ PROJECT TYPE: _____

MODEL #	/	/	/	X	/	/	/	/	/	/	/
EXAMPLE:	A	B	C	D	E	F	G	H	I	J	K
	HE1	41	E16	-	41	12WLED	3K	LDM120	FR3	CG1	41

*SKIP SECTION IF OPTION DOES NOT APPLY

NOTES: **BABA COMPLIANT**



HE2/62/E17/200WINC/FR4/CG2/62

A - SHADES

E-HE SERIES

- E1** - 12WLED (MAX), (3" GLASS), (3" GUARD)
- E2** - 25WLED (MAX), (4" GLASS), (4" GUARD)
- HE1** - 12WLED (MAX), (3" GLASS), (3" GUARD)
- HE2** - 25WLED (MAX), (4" GLASS), (4" GUARD)

B - FINISH OPTIONS

(SEE NOTES FOR LIMITATIONS)
 (SEE WEBSITE FOR SWATCH COLORS)
 20, 21, 22, 23, 40, 41, 41.5, 42, 43, 44, 45,
 46, 48, 49, 50, 51, 52, 53, 54, 55, 59, 60,
 61, 62, 63, 70, 71, 72, 73

C - MOUNTING OPTIONS

*ALL FIXTURES COMES AS IS. NO OTHER MOUNTING APPLIES
E16 - COMES STANDARD WITH E1 & HE1
E17 - COMES STANDARD WITH E2 & HE2

D - MOUNTING ADD-ONS

NOT AVAILABLE

E - MOUNTING COLOR

SEE SECTION "B" FOR COLOR OPTIONS.

F - LIGHT SOURCE

(SEE PAGE 2 FOR WATTAGE LIMITATIONS)
LIGHT EMITTED DIODE (LED)
 10W, 12W, 25W

*NOTE – MAX WATTAGE IS LISTED NEXT TO THE SHADE MODEL NUMBER IN SECTION "A". ALL WATTAGES BELOW THAT ARE ALSO AVAILABLE FOR THE SAME MODEL NUMBER.

G – LED COLOR TEMP

- 27K – 2700 KELVIN
- 3K – 3000 KELVIN
- 35K – 3500 KELVIN
- 4K – 4000 KELVIN
- 5K – 5000 K ELVIN

H – ELECTRICAL OPTION

(SEE PAGE 2 FOR DIMMING OPTION SPECIFICATIONS)
LDM120
LDM0-10

I – GLASS OPTIONS

3" GLASS (AVAILABLE FOR E1 & HE1)
 CL3, CLT3, BL3, RE3, GR3,
 AH3, FR3, FRT3, PR3
4" GLASS (AVAILABLE FOR E2 & HE2)
 CL4, CLT4, BL4, RE4, GR4,
 AH4, FR4, FRT4, PR4

J – ACCESSORIES

3" GUARDS (AVAILABLE FOR E1 & HE1)
 CG1, WG1
4" GUARDS (AVAILABLE FOR E2 & HE2)
 CG2, WG2

K – ACCESSORY COLOR

SEE SECTION "B" FOR COLOR OPTIONS.

NOTES

- FINISH OPTIONS 40, 49, 54, 61, 62, 63, 70, 71, 72, 73 ONLY AVAILABLE INSIDE AND OUT OF FIXTURE. OTHER FINISHES ARE WHITE INSIDE.
 - FINISH OPTIONS FOR SHADES ≤ 10" IN DIAMETER ARE THE SAME INSIDE AND OUT OF FIXTURE. SHADES > 10" IN DIAMETER ARE WHITE ON THE INSIDE.
 - FINISH OPTIONS 61, 62, 70, 71, 72, 73 ARE FINISHED WITH A SUPERCHROME ON THE INSIDE FOR ALL LED LIGHT SOURCE OPTIONS.
- *ALL ARMS COME WITH A CAST BACKPLATE (CB1/2", CB3/4", LWTM, CFWTM, ECT.).
 - *ACCORDING TO THE LIGHT SOURCE THE BACKPLATE MAY VARY IN SIZE. (EXAMPLE: LED LIGHT SOURCE WILL HAVE A DEEPER BACKPLATE TO HOUSE THE DRIVER.).
 - *ALL FIXTURES MOUNT TO A RECESSED 4-O JUNCTION BOX.
 - *FIXTURE DIMENSIONS MAY VARY ± 0.25.
 - *RATED FOR WET LOCATION.

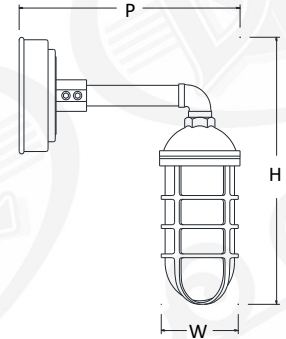

E1 H - 13.625" W - 4" PROJ. - 11.75"

E2 H - 16.125" W - 5.5" PROJ. - 13.75"
 3" GLASS & 3" GUARD AVAILABLE FOR E1
 4" GLASS & 4" GUARD AVAILABLE FOR E2

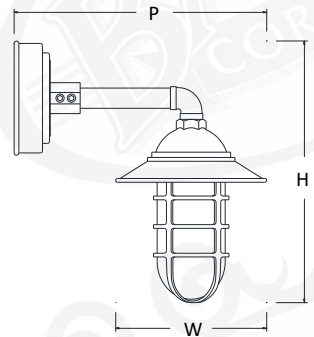

HE1 H - 13.625" W - 8" PROJ. - 13.625"

HE2 H - 16.125" W - 10" PROJ. - 15.75"
 3" GLASS & 3" GUARD AVAILABLE FOR HE1
 4" GLASS & 4" GUARD AVAILABLE FOR HE2



F – LIGHT SOURCE

BASELITE'S PUBLISHED LUMINAIRE PHOTOMETRIC TESTING WAS PERFORMED IN A 3-METER INTEGRATING SPHERE USING THE 4TT GEOMETRY METHOD. DATA IS CONSIDERED TO BE REPRESENTATIVE OF THE CONFIGURATIONS SHOWN, WITHIN THE TOLERANCES ALLOWED BY LIGHTING FACTS.

LIGHT EMITTING DIODE (LED)					
LED 12W (MAX) - E1, HE1 LED 25W (MAX) - E2, HE2			*IMPORTANT – FOR LIGHT EMITTED DIODE (LED) LIGHT SOURCE OPTION, FIXTURES ARE LIMITED DUE TO SIZE OF THE FIXTURE AND THE CORD WATTAGE RESTRICTIONS. PLEASE SEE MAX WATTAGE AVAILABILITY. EXAMPLE: / LED25W /		
OPTION	WATTAGE	LUMENS	CRI	VOLTAGE	DIMMING
LED10WF	10W	1280	>90	120-277 VAC	TRI-ELV *120V ONLY
LED12W	12W	1481	>90	120-277 VAC	See section "H"
LED25W	25W	2812	>90	120-277 VAC	See section "H"
@3500K					

H – ELECTRICAL OPTION

BASELITE'S ELECTRICAL OPTIONS ARE ONLY COMPATIBLE FOR CERTAIN FIXTURES, SO RESTRICTIONS APPLY DUE TO THE SIZE OF THE DRIVER AND FIXTURE. PLEASE SEE INFORMATION BELOW AND FOR FURTHER DETAILS CONTACT THE FACTORY.

LED DIMMING OPTIONS

(LED10WF – ONLY AVAILABLE WITH **LDM120** - TRI-ELV DIMMING OPITON) ALL OTHER WATTAGES CAN CHOOSE FROM THE OPTIONS BELOW. CONTACT DRIVER MANUFACTURER FOR FURTHER SPECIFICATIONS.

LDM120 - TRIAC / ELV – INPUT 120 / 277V - DIMMING AT 120 VOLT ONLY

LDM0-10V – 0 – 10V – DIMMING AT 120 / 277 VOLTS

I – GLASS OPTIONS

*3" GLASS AVAILABLE FOR E1 & HE1. *4" GLASS AVAILABLE FOR E2 & HE2



CL3 3" CLEAR GLASS

CL4 4" CLEAR GLASS



PR3 3" PRISMATIC GLASS

PR4 4" PRISMATIC GLASS



RE3 3" RED GLASS

RE4 4" RED GLASS



BL3 3" BLUE GLASS

BL4 4" BLUE GLASS



FR3 3" FROSTED GLASS

FR4 4" FROSTED GLASS



AH3 3" AMBER HYDE GLASS

AH4 4" AMBER HYDE GLASS



GR3 3" GREEN GLASS

GR4 4" GREEN GLASS

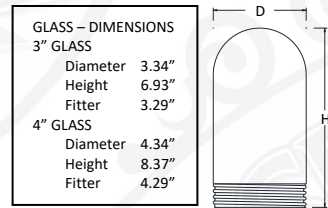

GLASS – MAX WATTAGE
 3" GLASS – 100W INC / LED12W
 4" GLASS – 200W INC / LED25W

J – ACCESSORIES

* 3" GUARDS AVAILABLE FOR E1 & HE1 * 4" GUARDS AVAILABLE FOR E2 & HE2

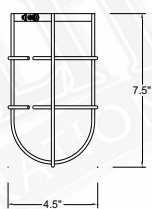

WG1 3" WIRE GUARD

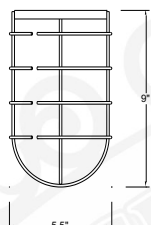

WG2 4" WIRE GUARD

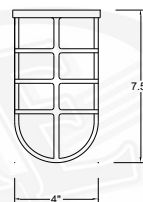

CG1 3" CAST GUARD

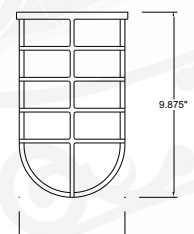

CG2 4" CAST GUARD