



# BASELITE – E – HE – CF – SPECIFICATION SHEET



PROJECT NAME: \_\_\_\_\_ PROJECT TYPE: \_\_\_\_\_

MODEL #	/	/	/	X	/	/	/	/	/	/	/
EXAMPLE:	A HE1	B 41	C E16	D -	E 41	F 12WINC	G 3K	H LDM120	I FR3	J CG1	K 41

\*SKIP SECTION IF OPTION DOES NOT APPLY

NOTES: **BABA COMPLIANT**

---



---



---



HE2/62/E17/200WINC/FR4/CG2/62

## A – SHADES

**E-HE SERIES**  
**E1** - 32WCF (MAX), (3" GLASS), (3" GUARD)  
**E2** - 42WCF (MAX), (4" GLASS), (4" GUARD)  
**HE1** - 32WCF (MAX), (3" GLASS), (3" GUARD)  
**HE2** - 42WCF (MAX), (4" GLASS), (4" GUARD)

## B - FINISH OPTIONS

(SEE NOTES FOR LIMITATIONS)  
 (SEE WEBSITE FOR SWATCH COLORS)  
 20, 21, 22, 23, 40, 41, 41.5, 42, 43, 44, 45,  
 46, 48, 49, 50, 51, 52, 53, 54, 55, 59, 60,  
 61, 62, 63, 70, 71, 72, 73

## C – MOUNTING OPTIONS

\* ALL FIXTURES COMES AS IS. NO OTHER MOUNTING APPLIES  
**E16** - COMES STANDARD WITH E1 & HE1  
**E17** - COMES STANDARD WITH E2 & HE2

## D – MOUNTING ADD-ONS

NOT AVAILABLE

## E – MOUNTING COLOR

SEE SECTION "B" FOR COLOR OPTIONS.

## F – LIGHT SOURCE

(SEE PAGE 2 FOR WATTAGE LIMITATIONS)  
**COMPACT FLUORESCENT (CF)**  
 26W, 32W, 42W

## G – LED COLOR TEMP

NOT AVAILABLE

## H – ELECTRICAL OPTION

(SEE PAGE 2 FOR DIMMING OPTION SPECIFICATIONS)  
**CDM120**  
**CDM277**  
**CDM120/277**

## I – GLASS OPTIONS

**3" GLASS** (AVAILABLE FOR E1 & HE1)  
 CL3, CLT3, BL3, RE3, GR3,  
 AH3, FR3, FRT3, PR3  
**4" GLASS** (AVAILABLE FOR E2 & HE2)  
 CL4, CLT4, BL4, RE4, GR4,  
 AH4, FR4, FRT4, PR4

## J – ACCESSORIES

**3" GUARDS** (AVAILABLE FOR E1 & HE1)  
 CG1, WG1  
**4" GUARDS** (AVAILABLE FOR E2 & HE2)  
 CG2, WG2

## K – ACCESSORY COLOR

SEE SECTION "B" FOR COLOR OPTIONS.

## NOTES

- FINISH OPTIONS 40, 49, 54, 61, 62, 63, 70, 71, 72, 73 ONLY AVAILABLE INSIDE AND OUT OF FIXTURE. OTHER FINISHES ARE WHITE INSIDE.
  - FINISH OPTIONS FOR SHADES ≤ 10" IN DIAMETER ARE THE SAME INSIDE AND OUT OF FIXTURE. SHADES > 10" IN DIAMETER ARE WHITE ON THE INSIDE.
  - FINISH OPTIONS 61, 62, 70, 71, 72, 73 ARE FINISHED WITH A SUPERCHROME ON THE INSIDE FOR ALL LED LIGHT SOURCE OPTIONS.
- \*ALL ARMS COME WITH A CAST BACKPLATE (CB1/2", CB3/4", LWTM, CFWTM, ECT.).
  - \*ACCORDING TO THE LIGHT SOURCE THE BACKPLATE MAY VARY IN SIZE. (EXAMPLE: LED LIGHT SOURCE WILL HAVE A DEEPER BACKPLATE TO HOUSE THE DRIVER.).
  - \*ALL FIXTURES MOUNT TO A RECESSED 4-O JUNCTION BOX.
  - \*FIXTURE DIMENSIONS MAY VARY ± 0.25.
  - \*RATED FOR WET LOCATION.

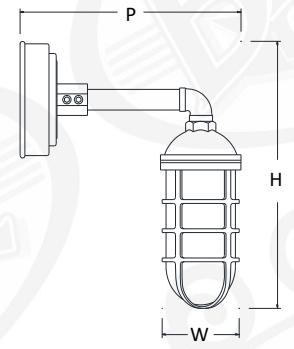

**E1** H - 13.625" W - 4" PROJ. - 11.75"

**E2** H - 16.125" W - 5.5" PROJ. - 13.75"

3" GLASS & 3" GUARD AVAILABLE FOR E1  
4" GLASS & 4" GUARD AVAILABLE FOR E2

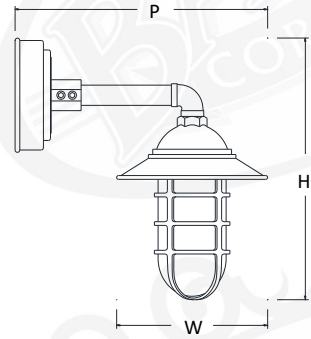

**HE1** H - 13.625" W - 8" PROJ. - 13.625"

**HE2** H - 16.125" W - 10" PROJ. - 15.75"

3" GLASS & 3" GUARD AVAILABLE FOR HE1  
4" GLASS & 4" GUARD AVAILABLE FOR HE2



**F – LIGHT SOURCE**

BASELITE'S PUBLISHED LUMINAIRE PHOTOMETRIC TESTING WAS PERFORMED IN A 3-METER INTEGRATING SPHERE USING THE 4TT GEOMETRY METHOD. DATA IS CONSIDERED TO BE REPRESENTATIVE OF THE CONFIGURATIONS SHOWN, WITHIN THE TOLERANCES ALLOWED BY LIGHTING FACTS.

**COMPACT FLUORESCENT (CF)**

**CF 26W, 32W(MAX) - E1, HE1**  
**CF 26W, 32W, OR 42W(MAX) - E2, HE2**

**\*IMPORTANT – FOR COMPACT FLUORESCENT (CF) LIGHT SOURCE, FIXTURES ARE LIMITED DUE TO THE SIZE OF THE SHADE. PLEASE SEE THE CHART TO THE LEFT TO SEE WHAT WATTAGE IS COMPARABLE FOR EACH FIXTURE WHEN ORDERING.**  
EXAMPLE: / CF42W /

OPTION	WATTAGE	LUMENS	CRI	VOLTAGE	DIMMING
CF26W	26W	PER BULB SPECS	>90	120-277 VAC	See section "H"
CF32W	32W	PER BULB SPECS	>90	120-277 VAC	See section "H"
CF42W	42W	PER BULB SPECS	>90	120-277 VAC	See section "H"

**H – ELECTRICAL OPTION**

MOST BASELITE'S ELECTRICAL OPTIONS ARE ONLY COMPATIBLE FOR CERTAIN FIXTURES. PLEASE SEE NOTES BELOW AND FOR FURTHER DETAILS CONTACT THE FACTORY. FOR DIMMING BALLAST OPTION, PLEASE CHOOSE MARK X OR MARK VII, SO RESTRICTIONS APPLY DUE TO THE SIZE OF THE BALLAST AND FIXTURE.

**COMPACT FLUORESCENT DIMMING OPTIONS**

PROVIDED WITH ADVANCE TRANSFORMER, PLEASE CHOOSE MARK 10 OR MARK 7 WITH SPECIFIED VOLTAGE FROM THE LIST BELOW. CONTACT BALLAST MANUFACTURER FOR SPECIFICATIONS.

- CDM7-120/277 - ADVANCE MARK 7 0-10v ELECTRICAL BALLST – 120/277 VOLT**
- CDM10-120 - ADVANCE MARK 10 ELECTRICAL BALLST – 120 VOLT**
- CDM10-277 - ADVANCE MARK 10 ELECTRICAL BALLST – 277 VOLT**

**I – GLASS OPTIONS**

\*NOTE : GLASS IS HEAT RESISTANCE BOROSILICATE. \*TEMPERD GLASS AVAILABLE UPON REQUEST. CONTACT YOUR LOCAL SALES REPRESENTATIVE FOR INFORMATION OR CALL FACTORY FOR QUESTIONS.  
\*3" GLASS AVAILABLE FOR E1 & HE1. \*4" GLASS AVAILABLE FOR E2 & HE2



**CL3** 3" CLEAR GLASS  
**CL4** 4" CLEAR GLASS



**PR3** 3" PRISMATIC GLASS  
**PR4** 4" PRISMATIC GLASS



**RE3** 3" RED GLASS  
**RE4** 4" RED GLASS



**BL3** 3" BLUE GLASS  
**BL4** 4" BLUE GLASS



**FR3** 3" FROSTED GLASS  
**FR4** 4" FROSTED GLASS



**AH3** 3" AMBER HYDE GLASS  
**AH4** 4" AMBER HYDE GLASS



**GR3** 3" GREEN GLASS  
**GR4** 4" GREEN GLASS

GLASS – DIMENSIONS	
3" GLASS	
Diameter	3.34"
Height	6.93"
Fitter	3.29"
4" GLASS	
Diameter	4.34"
Height	8.37"
Fitter	4.29"

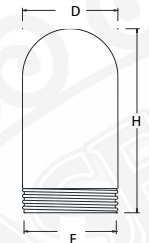

GLASS – MAX WATTAGE	
3" GLASS	– 100W INC / LED12W
4" GLASS	– 200W INC / LED25W

**J – ACCESSORIES**

\* 3" GUARDS AVAILABLE FOR E1 & HE1      \*4" GUARDS AVAILABLE FOR E2 & HE2

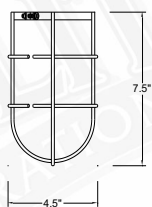

**WG1** 3" WIRE GUARD

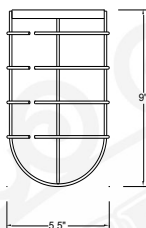

**WG2** 4" WIRE GUARD

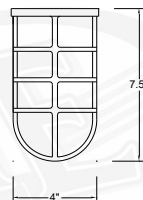

**CG1** 3" CAST GUARD

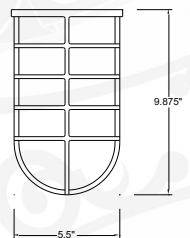

**CG2** 4" CAST GUARD