

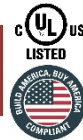

BASELITE - ARBOR – LED – SPECIFICATION SHEET



PROJECT NAME: _____ PROJECT TYPE: _____

NOTES: BABA COMPLIANT

*FOR A COMPLETE MODEL NUMBER, MAKE A SELECTION FROM THE DROP DOWNS BELOW. SKIP SECTIONS THAT DO NOT APPLY.

MODEL #	EXAMPLE:	W513	41	E16	SQ ½"	43	45LED	3K	LDM120	PR3	GR13	44
---------	----------	------	----	-----	-------	----	-------	----	--------	-----	------	----

A - SHADES

ARBOR

- W511 - 25LED (MAX)
- W5114 - 25LED (MAX)
- W513 - 25LED (MAX)
- W5134 - 25LED (MAX)
- W517 - 35LED (MAX)
- W5174 - 35LED (MAX)
- WV5174 - 35LED (MAX)
- SWS17 - 35LED (MAX)
- W5175 - 35LED (MAX)
- W5136 - 35LED (MAX)

B - FINISH OPTIONS

(SEE WEBSITE FOR SWATCH COLORS)
(*SEE NOTES FOR LIMITATIONS*)

- 14, 15, 16, 17, 18, 19, 19P, 20, 20P, 20PB, 20SB, 21, 21P, 22, 22P, 23, 23P, 38, 39, 40, 41, 41.5, 42, 43, 44, 45, 46, 48, 49, 50, 51, 52, 53, 54, 55, 57, 58, 59, 60, 61, 62, 63, 64, 65, 66, 70, 71, 72, 73, 74, 75, 76, 77, 78, 79, 80, 81, 82, 83, 84, 85, 86, 87, 88, 89, 90, 91, 92, 93, 94, 95, 96, 97, 98, 99, 100, MG.

C - MOUNTING OPTIONS

½" ARM EXTENSIONS

E1, E2, E2S, E3, E4, B1, E16, E17, E24, E27

¾" ARM EXTENSIONS

E3A, E4A, E5, E6, E7, E8, E9, E10, E11, E12, E13, B15, B15S, E19, E20, E21, E25

E14 - CREATE YOUR OWN

(BASELITE WILL TAKE YOUR SKETCH AND FABRICATE A CUSTOM ARM EXTENSION TO MEET YOUR NEEDS).

½" WALL MOUNT

B13, WM13R, WM13X, B10, B11, B101

¾" WALL MOUNT

B9, B9C, B12, WM14X, WM15, WM35X, WM55X, WM60X, WM61X WM70X, WM71X

LED CORD MOUNT

LBLC, LWHC, LTCB, LTCW, LTCHB, LTCHW, LTLB, LTLW, LTLB, LTLW, LRCB, LRCW, LRCHB, LRCHW, LFHB, LFHW, LHBLC, LHWHC, LCBLC, LCWHC, LCHB, LCHW

STEM MOUNT

ST6, ST12, ST18, ST24, ST36, ST48, STXX

D - MOUNTING ADD-ONS

LED ADD-ONS

LWTM, LSLC, LSTC

UNIVERSAL ADD-ONS

SQ ½", SQ ¾", FH ½", FH ¾", TRB ½", TRB ¾", SWL, LGSWL, CNK, INB, RINB

E - MOUNTING COLOR

SEE SECTION "B" FOR COLOR OPTIONS.

F - WATTAGE

(SEE PAGE 4 FOR WATTAGE LIMITATIONS)

LED WATTAGE OPTION

10, 12, 25, 35

*NOTE - MAX WATTAGE IS LISTED NEXT TO THE SHADE MODEL NUMBER IN SECTION "A". ALL WATTAGES BELOW THAT ARE ALSO AVAILABLE FOR THE SAME MODEL NUMBER.

G - LED COLOR TEMP

- 27K - 2700 KELVIN
- 3K - 3000 KELVIN
- 35K - 3500 KELVIN
- 4K - 4000 KELVIN
- 5K - 5000 KELVIN

H - ELECTRICAL OPTION

(SEE PAGE 4 FOR DIMMING OPTION SPECIFICATIONS)

LDM120

LDM0-10

I - GLASS OPTIONS

CL3, CL4, BL3, BL4, RE3, RE4, GR3, GR4, AH3, AH4, FR3, FR4, PR3, PR4, BA, BAX, BAF, PR8, PR8F, FN, OC

J - ACCESSORIES

GR11, GR13, GR17, REF, UGR, LGR11, LGR13, LGR17, CRL13, CRL17, FLE11, FLE13, FLE17, FGR11, FGR13, FGR17, GU-1, GU-2, WG-1, WG-2

K - ACCESSORY COLOR

SEE SECTION "B" FOR COLOR OPTIONS.

NOTES

- (1). FINISH OPTIONS 20, 21, 22, 23 ARE FOR SOLID BRASS FIXTURES ONLY.
- (2). FINISH OPTIONS 19, 21, 22, 23, 75, 76, 77, 83, 84, 88, 93 AND 98 ARE APPLIED BY HAND. THESE FINISHES WILL VARY IN CONSISTENCY.
- (3). FINISH OPTIONS 19, 38, 39, 40, 49, 54, 57, 58, 61, 62, 63, 70, 71, 72, 73, 78, 83, 84, 88, 92, 93, 98 ONLY AVAILABLE INSIDE AND OUT OF FIXTURE. OTHER FINISHES ARE WHITE INSIDE.
- (4). FINISH OPTIONS 61, 62, 70, 71, 72, 73 ARE FINISHED WITH A SUPERCHROME ON THE INSIDE FOR ALL LED LIGHT SOURCE OPTIONS.
- (5). COLOR CORDS ARE NOT APPLICABLE FOR LED OPTIONS.
- (6). ALL ARMS COME WITH A CAST BACKPLATE (CB1/2", CB3/4", LWTM, CFWTM, ECT.).
- (7). ACCORDING TO THE LIGHT SOURCE THE BACKPLATE MAY VARY IN SIZE. (EXAMPLE: LED LIGHT SOURCE WILL HAVE A DEEPER BACKPLATE TO HOUSE THE DRIVER.).
- (8). ALL FIXTURES MOUNT TO A 4-O JUNCTION BOX.
- (9). FIXTURE DIMENSIONS MAY VARY ±0.25.
- (10). CORD AND CANOPY COME IN THE SAME COLOR.

SHADE DIMENSIONS

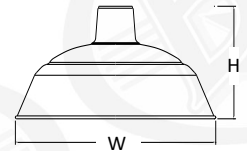

W513 H-8" W-13"
W517 H-8" W-17"

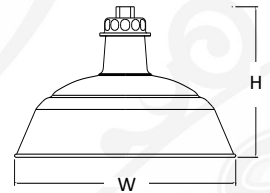

W5134 H-9.5" W-13"
W5174 H-9.5" W-17"

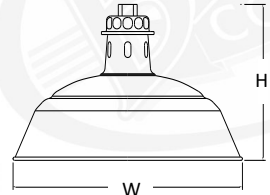

WV5174 H-9.5" W-17"
*SHADE RATED FOR DRY LOCATION ONLY

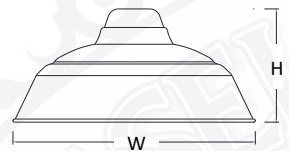

SWS17 H-9" W-17"

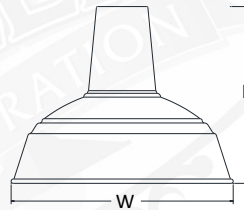

W5136 H-10.25" W-13"

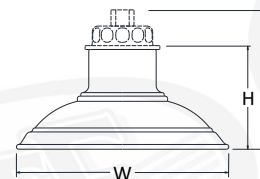

W511 H-5.5" W-11"

W5114 H-7.5" W-11"

*W5114 - WITH CAST ALUMINUM TOP
*W511 - NO TOP

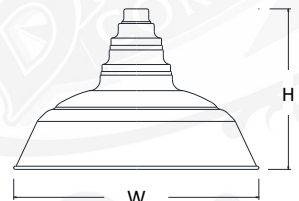

W5175 H-11" W-17"



C - MOUNTING OPTIONS

1/2" ARM EXTENSIONS

*ARMS RATED FOR WET LOCATION * MAXIMUM SECTIONS OF ARMS ARE DIMENSIONED



E1 9"(H) 19.75"(W)



E2 13.5"(H) 36.75"(W)



E2S 13.5"(H) 35"(W)



E3 16.5"(H) 26.5"(W)



E4 14.5"(H) 24"(W)

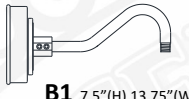

B1 7.5"(H) 13.75"(W)

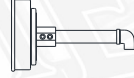

E16 6"(H) 10.25"(W)



E24 9.5"(H) 24"(W)

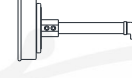

E17 6"(H) 11.25"(W)



E27 9"(H) 12.25"(W)

3/4" ARM EXTENSIONS

*ARMS RATED FOR WET LOCATION * MAXIMUM SECTIONS OF ARMS ARE DIMENSIONED

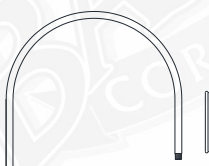

E20 85.5"(H) 27.25"(W)

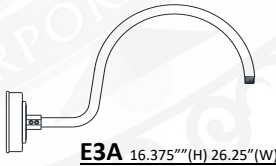

E3A 16.375"(H) 26.25"(W)

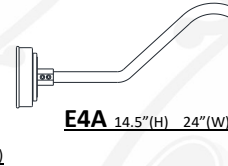

E4A 14.5"(H) 24"(W)

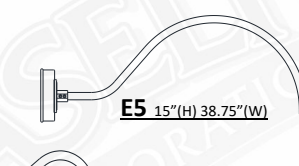

E5 15"(H) 38.75"(W)

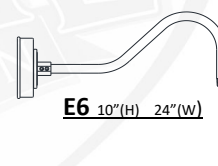

E6 10"(H) 24"(W)

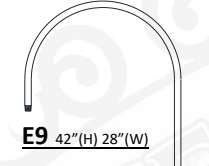

E9 42"(H) 28"(W)

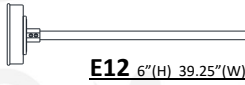

E12 6"(H) 39.25"(W)

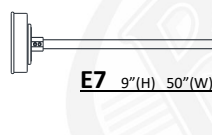

E7 9"(H) 50"(W)



E10 18"(H) 56"(W)

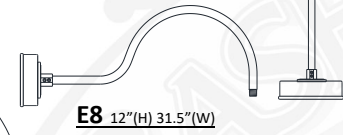

E8 12"(H) 31.5"(W)

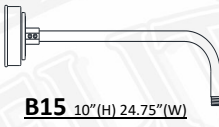

B15 10"(H) 24.75"(W)

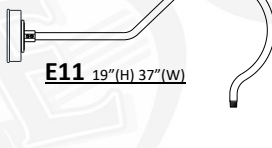

E11 19"(H) 37"(W)

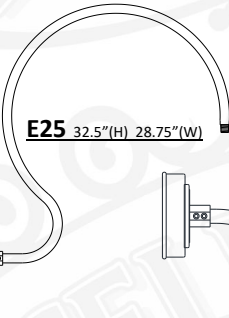

E25 32.5"(H) 28.75"(W)

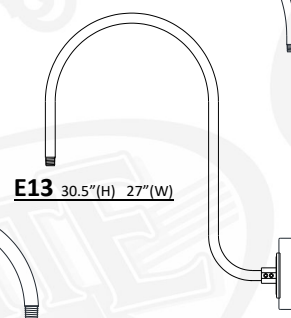

E13 30.5"(H) 27"(W)



B15S 10"(H) 19.75"(W)



E21 12"(H) 28.75"(W)

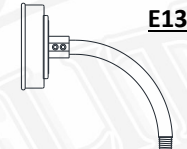

E19 10.625"(H) 11.5"(W)

NOTES:



- * All arms sold with Cast Backplate (CB)
- * Backplate may vary in size depending on light source.

E14



- * Baselite will take your sketch and fabricate a custom arm extension to meet your needs
- * Dimensions to be determined by customer

1/2" WALL MOUNTS

*MOUNTS RATED FOR WET LOCATION * MAXIMUM SECTIONS OF MOUNTS ARE DIMENSIONED

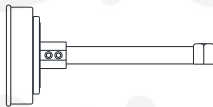

B10 6"(H) 12.5"(W)

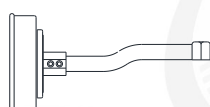

B101 6"(H) 13.5"(W)



B11 6"(H) 14.5"(W)



B13 6"(H) 16.5"(W)

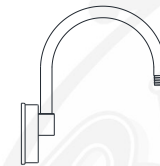

WM13R 12"(H) 9.5"(W)

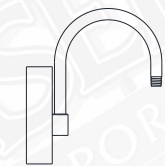

WM13X 12"(H) 10.5"(W)

3/4" WALL MOUNTS

*MOUNTS RATED FOR WET LOCATION * MAXIMUM SECTIONS OF MOUNTS ARE DIMENSIONED



B12 6"(H) 15.5"(W)



B9 5"(H) 18"(W)

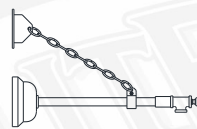

B9C 5"(H) 18"(W)

*CHAIN HEIGHT TBD BY CUSTOMER



WM14X 18"(H) 14"(W)



WM15 23"(H) 19.5"(W)

C - MOUNTING OPTIONS (CONTINUED)

3/4" WALL MOUNTS

*MOUNTS RATED FOR WET LOCATION * MAXIMUM SECTIONS OF MOUNTS ARE DIMENSIONED



WM35X 26"(H) 22"(W)



WM55X 19"(H) 27"(W)

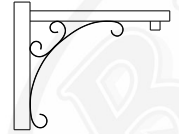

WM60X 18"(H) 22"(W)

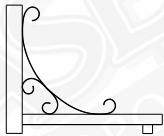

WM61X 18"(H) 22"(W)

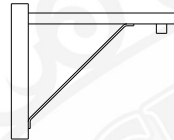

WM70X 18"(H) 22"(W)

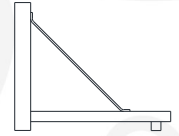

WM71X 18"(H) 22"(W)

STEM MOUNTS

*STEMS RATED FOR DAMP LOCATION

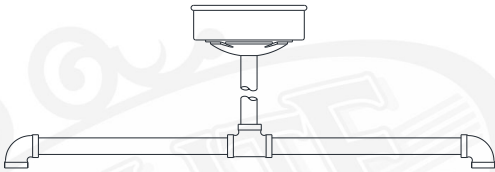

DP24 DOUBLE PENDANT 20"(H) 24"(W)

*DP24 COMES STANDARD WITH LSTC AND ST18



ST(XX) STEM- 1/2" NPT

XX = LENGTH OF STEM
(EXAMPLE - "ST18" = STEM MOUNT 18" LENGTH)
*CANOPY NOT INCLUDED, ADD IN SECTION D
* 1/4" NPT AND 3/4" NPT AVAILABLE UPON REQUEST



SC24 SCROLL STEM 33"(H) 26"(W)

*SC24 COMES STANDARD WITH LSTC

LED CORD MOUNTS

*FOR LED & COMPACT FLUORESCENT OPTIONS, CANOPIES WILL VARY IN SIZE DUE TO SIZE OF THE DRIVER/BALLAST THAT WILL BE LOCATED INSIDE OF THE CANOPY. *CORDS RATED FOR DRY LOCATION
*CANOPY DIMENSIONS: 4" (H) 5.5" (W) *CORD AND CANOPY COME IN THE SAME COLOR.

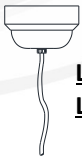

LBLC 8' BLACK CORD

LWHC 8' WHITE CORD



LTCB 8' BLACK CORD, CABLE, and LOOP

LTCW 8' WHITE CORD, CABLE, and LOOP



LTCHB 8' BLACK CORD, 3' CHAIN, and LOOP

LTCW 8' WHITE CORD, 3' CHAIN, and LOOP



LTLB 8' BLACK TELEPHONE CORD AND CABLE

LTLW 8' WHITE TELEPHONE CORD AND CABLE

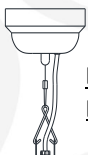

LRCB 8' BLACK CORD, CABLE, and LOOP

LRCW 8' WHITE CORD, CABLE, and LOOP



LRCHB 8' BLACK CORD, 3' CHAIN, and LOOP

LRCHW 8' WHITE CORD, 3' CHAIN, and LOOP



LFBH 8' BLACK CORD WITH FLAT HUB

LFWH 8' WHITE CORD WITH FLAT HUB



LCBLC 8' BLACK CORD and CABLE

LCWHC 8' WHITE CORD and CABLE



LCHB 8' BLACK CORD, 3' CHAIN, and LOOP

LCHW 8' WHITE CORD, 3' CHAIN, and LOOP

* Loop may vary due to shade style

10'

NOTES:
*DISTANCE TO LAMP (CF) 10'
*All compact fluorescent and LED housings may vary in size according to light source chosen.



D - MOUNTING ADD-ONS

LED - STEM AND ARM ADD-ONS

* FOR LED & COMPACT FLUORESCENT OPTIONS, CANOPIES WILL VARY IN SIZE DUE TO SIZE OF THE DRIVER/BALLAST THAT WILL BE LOCATED INSIDE OF THE CANOPY.

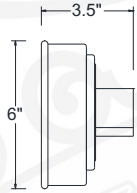

LWTM WEATHERTIGHT LED WALL MOUNT

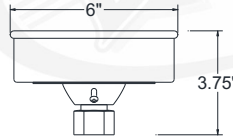

LSLC LED SLOPE CEILING CANOPY

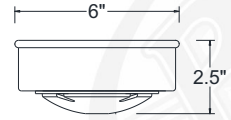

LSTC LED STEM MOUNT CANOPY

UNIVERSAL STEM AND ARM ADD-ONS

* EXAMPLE FOR MULTIPLE MOUNTING ADD-ONS:

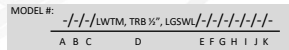

CNK CANOPY For MULTIPLE FIXTURES

*CNK dimensions vary on number of fixtures applied

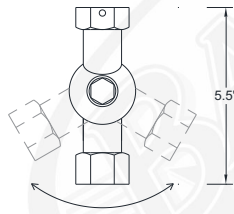

LGSWL 1/2" NPT SWIVEL

*For all shades greater than 7" wide in diameter

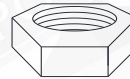

FH 1/2" FLAT HUB 1/2"

FH 3/4" FLAT HUB 3/4"

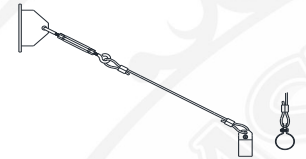

TRB 1/2" - 4' CABLE SUPPORT

TRB 3/4" - 4' CABLE SUPPORT

F - WATTAGE

BASELITE'S PUBLISHED LUMINAIRE PHOTOMETRIC TESTING WAS PERFORMED IN A 3-METER INTEGRATING SPHERE USING THE 4TT GEOMETRY METHOD. DATA IS CONSIDERED TO BE REPRESENTATIVE OF THE CONFIGURATIONS SHOWN, WITHIN THE TOLERANCES ALLOWED BY LIGHTING FACTS.

LIGHT EMITTING DIODE (LED)

25 LED (MAX) – W511, W5114, W513, W5134
35 LED (MAX) – W517, W5174, WV5174, SWS17, W5175, W5136

***IMPORTANT** – FOR LIGHT EMITTED DIODE (LED) LIGHT SOURCE OPTION, FIXTURES ARE LIMITED DUE TO SIZE OF THE FIXTURE AND THE CORD WATTAGE RESTRICTIONS. PLEASE SEE MAX WATTAGE AVAILABILITY. **EXAMPLE:** /35LED/

OPTION	WATTAGE	LUMENS	CRI	VOLTAGE	DIMMING
10LED	10	1280	>90	120-277 VAC	TRI-ELV *120V ONLY
12LED	12	1481	>90	120-277 VAC	See section "H"
25LED	25	2812	>90	120-277 VAC	See section "H"
35LED	35	3743	>90	120-277 VAC	See section "H"
		@3500K			

*FIXTURE WATTAGE CAN BE DE-RATED TO MEET CODE COMPLIANCE "XXMED" – XX = DESIRED WATTAGE RATING BELOW MAX.

H – ELECTRICAL OPTION

LED DIMMING OPTIONS

(LED10WF – ONLY AVAILABLE WITH LDM120 - TRI-ELV DIMMING OPITON) ALL OTHER WATTAGES CAN CHOOSE FROM THE OPTIONS BELOW. CONTACT DRIVER MANUFACTURER FOR FURTHER SPECIFICATIONS.

LDM120 - TRIAC / ELV – INPUT 120 / 277V - DIMMING AT 120 VOLT ONLY

LDM0-10V – 0 – 10V – DIMMING AT 120 / 277 VOLTS

I – GLASS OPTIONS

NOTE : GLASS IS HEAT RESISTANCE BOROSILICATE. *TEMPERD GLASS AVAILABLE UPON REQUEST. CONTACT YOUR LOCAL SALES REPRESENTATIVE FOR INFORMATION OR CALL FACTORY FOR QUESTIONS.



CL3 3" CLEAR GLASS	PR3 3" PRISMATIC GLASS	RE3 3" RED GLASS	BL3 3" BLUE GLASS
CL4 4" CLEAR GLASS	PR4 4" PRISMATIC GLASS	RE4 4" RED GLASS	BL4 4" BLUE GLASS
FR3 3" FROSTED GLASS	AH3 3" AMBER HYDE GLASS	GR3 3" GREEN GLASS	
FR4 4" FROSTED GLASS	AH4 4" AMBER HYDE GLASS	GR4 4" GREEN GLASS	

GLASS – DIMENSIONS	
3" GLASS	
Diameter	3.34"
Height	6.93"
Fitter	3.29"
4" GLASS	
Diameter	4.34"
Height	8.37"
Fitter	4.29"

GLASS – MAX WATTAGE	
3" GLASS	100W INC / LED25W
4" GLASS	200W INC / LED25W



BA 6" OPAL BALL (100W INC MAX/LED12W)	BAX 9" CLEAR GLOBE BAF 9" FROSTED GLOBE (200W INC MAX/LED25W)	FN 8" CLEAR TEXTURED GLOBE (150W INC MAX/LED25W)
BA7 7" CLEAR GLOBE BA7F 7" FROSTED GLOBE (100W INC MAX/LED25W)	PR8 8" PRISMATIC PR8F 8" PRISMATIC FROSTED (200W INC MAX/LED45W)	OC 8" OPAL TAPERED GLOBE (60W INC MAX/LED25W)

J – ACCESSORIES

NOTE : DUE TO THE SIZE OF THE LED BUBBLE, WATTAGE RESTRICTIONS APPLY TO WIRE AND CAST GUARDS - WG-1 & GU-1 LED 12W MAX - WG-2 & GU-2 LED 30W MAX

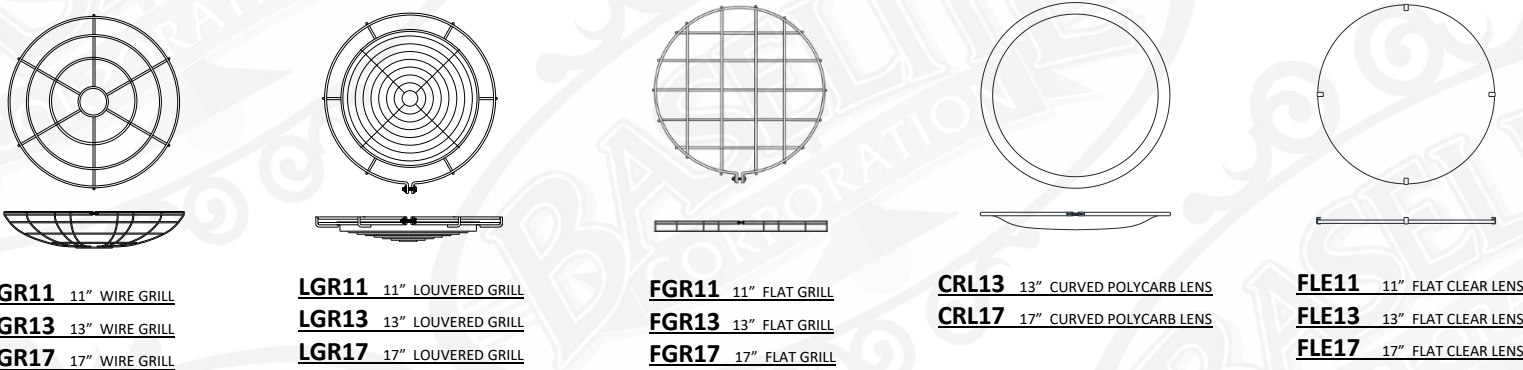

GR11 11" WIRE GRILL	LGR11 11" LOUVERED GRILL	FGR11 11" FLAT GRILL	CRL13 13" CURVED POLYCARB LENS	FLE11 11" FLAT CLEAR LENS
GR13 13" WIRE GRILL	LGR13 13" LOUVERED GRILL	FGR13 13" FLAT GRILL	CRL17 17" CURVED POLYCARB LENS	FLE13 13" FLAT CLEAR LENS
GR17 17" WIRE GRILL	LGR17 17" LOUVERED GRILL	FGR17 17" FLAT GRILL		FLE17 17" FLAT CLEAR LENS

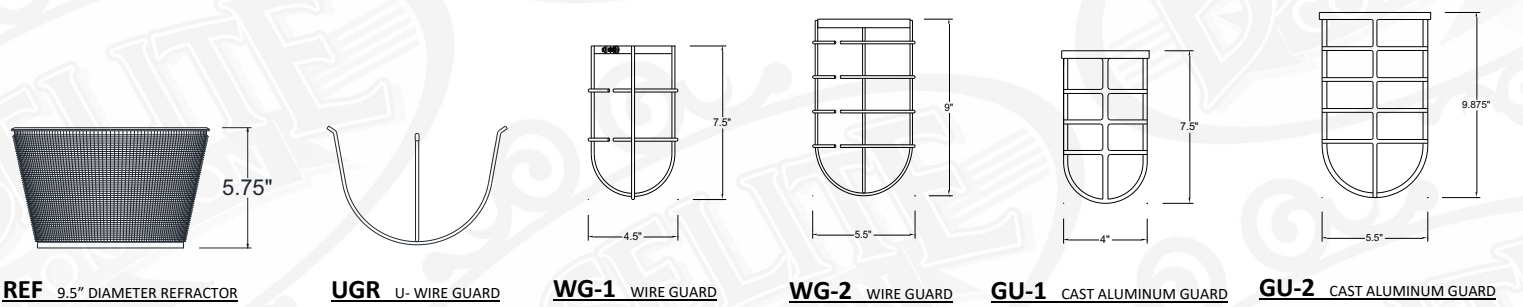

REF 9.5" DIAMETER REFRACTOR	UGR U- WIRE GUARD	WG-1 WIRE GUARD	WG-2 WIRE GUARD	GU-1 CAST ALUMINUM GUARD	GU-2 CAST ALUMINUM GUARD
------------------------------------	--------------------------	------------------------	------------------------	---------------------------------	---------------------------------