



BASELITE – MODERN PENDANTS – LED – SPEC SHEET



PROJECT NAME: _____ PROJECT TYPE: _____

MODEL #	/	/	/	/	/	/	/	/	/	X	X	X
	A	B	C	D	E	F	G	H	I	J	K	
EXAMPLE:	3TD	80-59-81	BLC	CNK	41	25WLED	35K	LDM120	-	-	-	

*SKIP SECTION IF OPTION DOES NOT APPLY

NOTES:



A - SHADES

MODERN PENDANTS

- 3TD – 3-25WLED (MAX)
- 3PEH – 3-25WLED (MAX)
- 3PE – 3-25WLED (MAX)
- PEA – 25WLED (MAX)
- PEB – 25WLED (MAX)
- PEC – 25WLED (MAX)
- PED – 25WLED (MAX)
- PEF – 25WLED (MAX)
- PEG – 25WLED (MAX)
- PEH – 25WLED (MAX)
- PEI – 25WLED (MAX)
- PEJ – 25WLED (MAX)
- PEK – 25WLED (MAX)
- PEO – 35WLED (MAX)
- PEOB – 25WLED (MAX)
- PEP – 35WLED (MAX)
- PEQ – 35WLED (MAX)
- PER – 25WLED (MAX)
- PES – 25WLED (MAX)
- PET – 25WLED (MAX)
- PEU – 25WLED (MAX)
- PEV – 25WLED (MAX)
- PEY – 80WLED (MAX)
- PEX – 25WLED (MAX)
- PEZ – 25WLED (MAX)
- DMD10 – 25WLED (MAX)
- SQB618 – 25WLED (MAX)
- S1 – N/A (LED LAMP ONLY)
- TD8 – 25WLED (MAX)
- TD10 – 25WLED (MAX)
- TD12 – 25WLED (MAX)
- PEHD615 – 25WLED (MAX)
- MPA – 25WLED (MAX)

B - FINISH OPTIONS

(SEE WEBSITE FOR SWATCH COLORS)
 (**SEE NOTES FOR LIMITATIONS*)
 14, 15, 16, 17, 18, 19, 19P, 20, 20P, 20PB,
 20SB, 21, 21P, 22, 22P, 23, 23P, 38, 39, 40,
 41, 41.5, 42, 43, 44, 45, 46, 48, 49, 50, 51,
 52, 53, 54, 55, 57, 58, 59, 60, 61, 62, 63, 64,
 65, 66, 70, 71, 72, 73, 74, 75, 76, 77, 78, 79,
 80, 81, 82, 83, 84, 85, 86, 87, 88, 89, 90, 91,
 92, 93, 94, 95, 96, 97, 98, 99, 100, MG.

C – MOUNTING OPTIONS

- LED CORD MOUNT**
 LMCB, LMCW, LMTCB, LMTCW, LMTCHB,
 LMTCHW, LMTLB, LMTLW, LMRCB, LMRCW,
 LMRCHB, LMRCHW, LMFHB, LMFHW,
 LMCBLC, LMCWLC, LMCHB, LMCHW
- STEM MOUNT (INC)**
 ST6, ST12, ST18, ST24, ST36, ST48, STXX

D – MOUNTING ADD-ONS

- INC ADD-ONS**
 CNK – MULTIPLE FIXTURE CANOPY
 STC – STEM MOUNT CANOPY
 SLC1/2" – SLOPE CEILING CANOPY ½"

E – MOUNTING COLOR

SEE SECTION "B" FOR COLOR OPTIONS.

F – LIGHT SOURCE

- (SEE PAGE 3 FOR WATTAGE LIMITATIONS)
LIGHT EMITTED DIODE (LED)
 10W, 12W, 25W
- *NOTE – MAX WATTAGE IS LISTED NEXT TO THE SHADE MODEL NUMBER IN SECTION "A". ALL WATTAGES BELOW THAT ARE ALSO AVAILABLE FOR THE SAME MODEL NUMBER.

G – LED COLOR TEMP

- 27K – 2700 KELVIN
- 3K – 3000 KELVIN
- 35K – 3500 KELVIN
- 4K – 4000 KELVIN
- 5K – 5000 KELVIN

H – ELECTRICAL OPTION

- (SEE PAGE 3 FOR DIMMING OPTION SPECIFICATIONS)
LDM120
LDM0-10

I – GLASS OPTIONS

CALL FACTORY FOR REQUEST.

J – ACCESSORIES

CALL FACTORY FOR REQUEST.

K – ACCESSORY COLOR

SEE SECTION "B" FOR COLOR OPTIONS.

NOTES

- (1). FINISH OPTIONS 20, 21, 22, 23 ARE FOR SOLID BRASS FIXTURES ONLY.
- (2). FINISH OPTIONS 19, 21, 22, 23, 75,76, 77, 83, 84, 88, 93 AND 98 ARE APPLIED BY HAND. THESE FINISHES WILL VARY IN CONSISTENCY.
- (3). FINISH OPTIONS FOR SHADES ≤ 10" IN DIAMETER ARE THE SAME INSIDE AND OUT OF FIXTURE. SHADES > 10" IN DIAMETER ARE WHITE ON THE INSIDE.
- (4). FINISH OPTIONS 19, 38, 39, 40, 49, 54, 57, 58, 61, 62, 63, 70, 71, 72, 73, 78, 83, 84, 88, 92, 93, 98 ONLY AVAILABLE INSIDE AND OUT OF FIXTURE. OTHER FINISHES ARE WHITE INSIDE.
- (5). FINISH OPTIONS 61, 62, 70, 71, 72, 73 ARE FINISHED WITH A SUPERCHROME ON THE INSIDE FOR ALL LED LIGHT SOURCE OPTIONS.
- (6). COLOR CORDS ARE NOT APPLICABLE FOR LED OPTIONS.
 *ALL FIXTURES MOUNT TO A 4-O JUNCTION BOX.
 *FIXTURE DIMENSIONS MAY VARY ± 0.25.

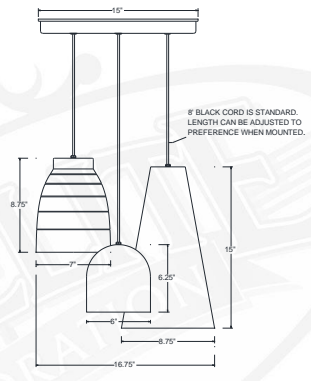

3PE H-TBD W-16.75"

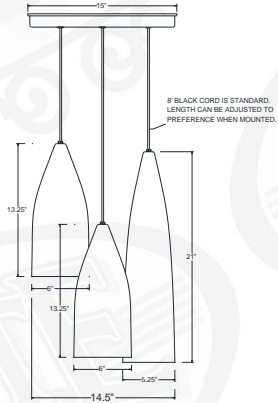

3PEH H-TBD W-14.5"

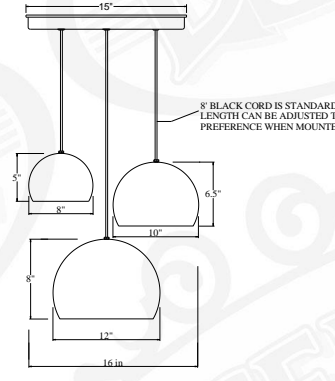

3TD H-TBD W-16"



PEA H-15" W-8.75"



PEB H-6.25" W-6"



PEC H-8.75" W-7"



PROJECT NAME: _____ PROJECT TYPE: _____

A - SHADES



PED H-11" W-4.5"



PEF H-13" W-12"

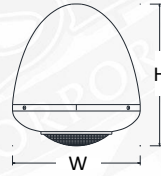

PEG H-11" W-10"



PEH H-13.25" W-6"
PEI H-21" W-5.25"

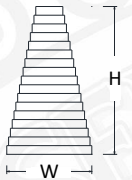

PEJ H-10" W-5.75"
PEK H-7.5" W-5"



PEOB H-12" W-7"

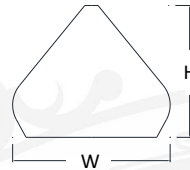

PEP H-15" W-18"



PEQ H-13.5" W-16"



PEO H-16.5" W-14"



PES H-11.75" W-22.5"

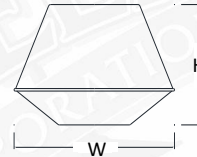

PET H-12" W-18"



PEU H-9.5" W-14.25"

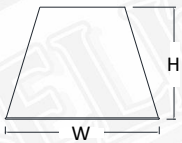

PER H-10.5" W-14.5"



PEX H-11" W-12"

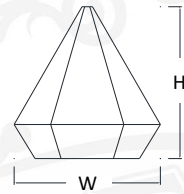

DMD10 H-14.5" W-14"



SQB618 H-18" W-6"



PEV H-14.25" W-16.25"

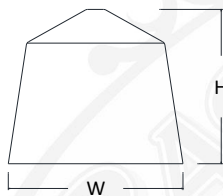

PEY H-16.75" W-19"

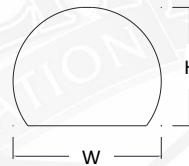

TD8 H-6.625" W-8"

TD10 H-8" W-10"

TD12 H-9.375" W-12"

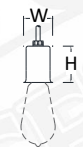

S1 H-2.625" W-2"



MPA H-14" W-5.5"

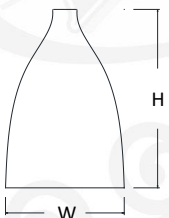

PEZ H-14.5" W-9.75"



C - MOUNTING OPTIONS

D - MOUNTING ADD-ONS

STEM MOUNT

*STEMS RATED FOR DAMP LOCATION * 1/4" NPT AND 3/4" NPT AVAILABLE UPON REQUEST



ST(XX) STEM- 1/2"
XX = LENGTH OF STEM
(EXAMPLE - "ST18" = STEM MOUNT 18" LENGTH)
*CANOPY NOT INCLUDED, ADD IN SECTION D

MOUNTING ADD-ON



CNK CANOPY For MULTIPLE FIXTURES

*CNK dimensions vary on number of fixtures applied

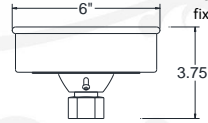

LSLC 1/2" SLOPE CEILING CANOPY 1/2"
*(Slopes To 20 Degrees)

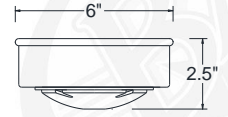

LSTC 1/2" 1/2" STEM MOUNT CANOPY

LED CORD MOUNTS

FOR LED & COMPACT FLUORESCENT OPTIONS, CANOPIES WILL VARY IN SIZE DUE TO SIZE OF THE DRIVER/BALLAST THAT WILL BE LOCATED INSIDE OF THE CANOPY. *CORDS RATED FOR DRY LOCATION *CANOPY DIMENSIONS: 2.5" (H) 5.875" (W)



LMCB 8' BLACK CORD
LMCW 8' WHITE CORD



LMTCB 8' BLACK CORD, CABLE, and LOOP
LMTCW 8' WHITE CORD, CABLE, and LOOP



LMTCHB 8' BLACK CORD, 3' CHAIN, and LOOP
LMTCHW 8' WHITE CORD, 3' CHAIN, and LOOP



LMTLB 8' BLACK TELEPHONE CORD AND CABLE
LMTLW 8' WHITE TELEPHONE CORD AND CABLE

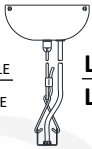

LMRCB 8' BLACK CORD, CABLE, and LOOP
LMRCW 8' WHITE CORD, CABLE, and LOOP



LMRCHB 8' BLACK CORD, 3' CHAIN, and LOOP
LMRCHW 8' WHITE CORD, 3' CHAIN, and LOOP



LMFHB 8' BLACK CORD WITH FLAT HUB
LMFHW 8' WHITE CORD WITH FLAT HUB

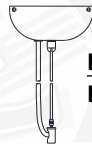

LMCBLC 8' BLACK CORD and CABLE
LMCWHC 8' WHITE CORD and CABLE



LMCHB 8' BLACK CORD, 3' CHAIN, and LOOP
LMCHW 8' WHITE CORD, 3' CHAIN, and LOOP
* Loop may vary due to shade style

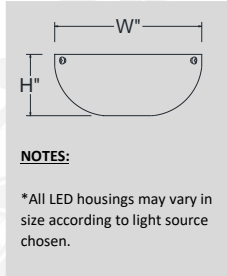

F - LIGHT SOURCE

BASELITE'S PUBLISHED LUMINAIRE PHOTOMETRIC TESTING WAS PERFORMED IN A 3-METER INTEGRATING SPHERE USING THE 4TT GEOMETRY METHOD. DATA IS CONSIDERED TO BE REPRESENTATIVE OF THE CONFIGURATIONS SHOWN, WITHIN THE TOLERANCES ALLOWED BY LIGHTING FACTS.

LIGHT EMITTING DIODE (LED)

LED 25W (MAX) - 3TD, 3PEH, 3PE, PELB, PEMB, PENB, TD8, TD10, TD12, PEA, PEB, PEC, PED, PEF, PEG, PEH, PEI, PEJ, PEK, PER, PES, PET, PEU, PEV, PEX, PEZ, DMD10, SQB618, WRO, WRO1, WRO2, PEHD615, MPA
LED 35W (MAX) - PEO, PEP, PEQ
LED 80W (MAX) - PEY

***IMPORTANT** - FOR LIGHT EMITTED DIODE (LED) LIGHT SOURCE OPTION, FIXTURES ARE LIMITED DUE TO SIZE OF THE FIXTURE AND THE CORD WATTAGE RESTRICTIONS. PLEASE SEE MAX WATTAGE AVAILABILITY.

EXAMPLE: / LED25W /

OPTION	WATTAGE	LUMENS	CRI	VOLTAGE	DIMMING
LED10WF	10W	1280	>90	120-277 VAC	TRI-ELV *120V ONLY
LED12W	12W	1481	>90	120-277 VAC	See section "H"
LED25W	25W	2812	>90	120-277 VAC	See section "H"
LED35W	35W	3743	>90	120-277 VAC	See section "H"
LED80W	80W	8800	>90	120-277 VAC	See section "H"

@3500K

H - ELECTRICAL OPTION

MOST BASELITE'S ELECTRICAL OPTIONS ARE ONLY COMPATIBLE FOR CERTAIN FIXTURES. PLEASE SEE NOTES BELOW AND FOR FURTHER DETAILS CONTACT THE FACTORY.

LED DIMMING OPTIONS

(LED10WF - ONLY AVAILABLE WITH **LDM120** - TRI-ELV DIMMING OPITON) ALL OTHER WATTAGES CAN CHOOSE FROM THE OPTIONS BELOW. CONTACT DRIVER MANUFACTURER FOR FURTHER SPECIFICATIONS.

LDM120 - TRIAC / ELV - INPUT 120 / 277V - DIMMING AT 120 VOLT ONLY
LDM0-10V - 0 - 10V - DIMMING AT 120 / 277 VOLTS