



BASELITE – MODERN PENDANTS – INC – SPEC SHEET



PROJECT NAME: _____ PROJECT TYPE: _____

MODEL #	/	/	/	/	/	/	X	X	X	X	X
EXAMPLE:	3TD	80-59-81	BLC	CNK	41	150INC					

*SKIP SECTION IF OPTION DOES NOT APPLY

NOTES:



A - SHADES

MODERN PENDANTS

- 3TD - 100WINC (MAX)
- 3PEH - 100WINC (MAX)
- 3PE - 100WINC (MAX)
- PEA - 150WINC (MAX)
- PEB - 150WINC (MAX)
- PEC - 150WINC (MAX)
- PED - 150WINC (MAX)
- PEF - 150WINC (MAX)
- PEG - 150WINC (MAX)
- PEH - 150WINC (MAX)
- PEI - 150WINC (MAX)
- PEJ - 150WINC (MAX)
- PEK - 150WINC (MAX)
- PEO - 150WINC (MAX)
- PEOB - 100WINC (MAX)
- PEP - 150WINC (MAX)
- PEQ - 150WINC (MAX)
- PER - 150WINC (MAX)
- PES - 150WINC (MAX)
- PET - 150WINC (MAX)
- PEU - 150WINC (MAX)
- PEV - 150WINC (MAX)
- PEX - 150WINC (MAX)
- PEY - 150WINC (MAX)
- PEZ - 150WINC (MAX)
- DMD10 - 150WINC (MAX)
- SQB618 - 150WINC (MAX)
- S1 - 100WINC (MAX)
- TD8 - 100WINC (MAX)
- TD10 - 100WINC (MAX)
- TD12 - 100WINC (MAX)
- PEHD615 - 150WINC (MAX)
- MPA - 100WINC (MAX)
- BON18 - 100WINC (MAX)

B - FINISH OPTIONS

(SEE WEBSITE FOR SWATCH COLORS)
 (*SEE NOTES FOR LIMITATIONS*)
 14, 15, 16, 17, 18, 19, 19P, 20, 20P,
 20PB, 20SB, 21, 21P, 22, 22P, 23, 23P,
 38, 39, 40, 41, 41.5, 42, 43, 44, 45, 46,
 48, 49, 50, 51, 52, 53, 54, 55, 57, 58, 59,
 60, 61, 62, 63, 64, 65, 66, 70, 71, 72, 73,
 74, 75, 76, 77, 78, 79, 80, 81, 82, 83, 84,
 85, 86, 87, 88, 89, 90, 91, 92, 93, 94, 95,
 96, 97, 98, 99, 100, MG.

C – MOUNTING OPTIONS

CORD MOUNT (INC)
 MCB, MCW, MTCB, MTCW, MTCHB, MTCHW,
 MTLB, MTLW, MRCB, MRCW, MRCHB,
 MRCHW, MFHB, MFHW, MCBLC, MCWLC,
 MCHB, MCHW

STEM MOUNT (INC)
 ST6, ST12, ST18, ST24, ST36, ST48, STXX

D – MOUNTING ADD-ONS

INC ADD-ONS
 CNK – MULTIPLE FIXTURE CANOPY
 STC – STEM MOUNT CANOPY
 SLC1/2" – SLOPE CEILING CANOPY 1/2"

E – MOUNTING COLOR

SEE SECTION "B" FOR COLOR OPTIONS.

F – LIGHT SOURCE

(SEE PAGE 3 FOR WATTAGE LIMITATIONS)
INCANDESCENT (INC)
 100w, 150W, 200W

G – LED COLOR TEMP

NOT AVAILABLE

H – ELECTRICAL OPTION

NOT AVAILABLE

I – GLASS OPTIONS

CALL FACTORY FOR REQUEST.

J – ACCESSORIES

CALL FACTORY FOR REQUEST.

K – ACCESSORY COLOR

SEE SECTION "B" FOR COLOR OPTIONS.

NOTES

- (1). FINISH OPTIONS 20, 21, 22, 23 ARE FOR SOLID BRASS FIXTURES ONLY.
 - (2). FINISH OPTIONS 19, 21, 22, 23, 75, 76, 77, 83, 84, 88, 93 AND 98 ARE APPLIED BY HAND. THESE FINISHES WILL VARY IN CONSISTENCY.
 - (3). FINISH OPTIONS FOR SHADES ≤ 10" IN DIAMETER ARE THE SAME INSIDE AND OUT OF FIXTURE. SHADES > 10" IN DIAMETER ARE WHITE ON THE INSIDE.
 - (4). FINISH OPTIONS 19, 38, 39, 40, 49, 54, 57, 58, 61, 62, 63, 70, 71, 72, 73, 78, 83, 84, 88, 92, 93, 98 ONLY AVAILABLE INSIDE AND OUT OF FIXTURE. OTHER FINISHES ARE WHITE INSIDE.
 - (5). FINISH OPTIONS 61, 62, 70, 71, 72, 73 ARE FINISHED WITH A SUPERCHROME ON THE INSIDE FOR ALL LED LIGHT SOURCE OPTIONS. (5). COLOR CORDS ARE NOT APPLICABLE FOR LED OPTIONS.
- *ALL FIXTURES MOUNT TO A 4-O JUNCTION BOX.
 *FIXTURE DIMENSIONS MAY VARY ±0.25.

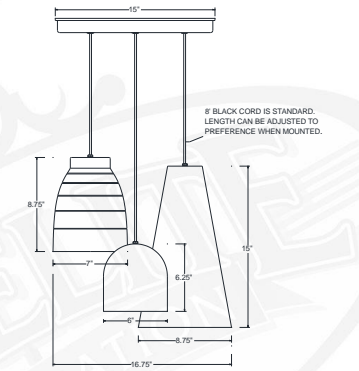

3PE H-TBD W-16.75"

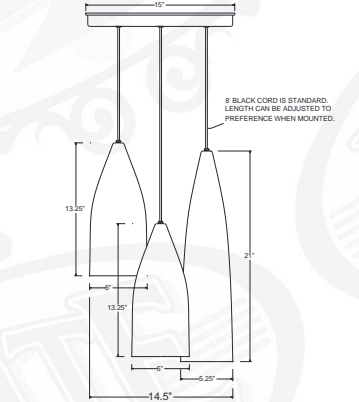

3PEH H-TBD W-14.5"

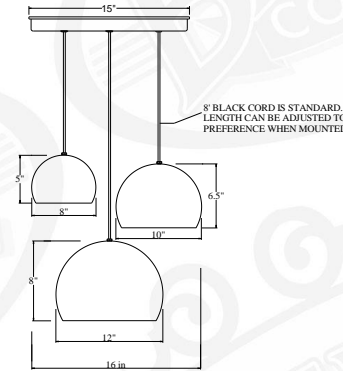

3TD H-TBD W-16"

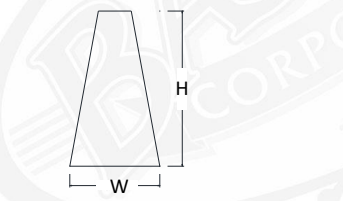

PEA H-15" W-8.75"



PEB H-6.25" W-6"



PEC H-8.75" W-7"

PROJECT NAME: _____ PROJECT TYPE: _____

A - SHADES



PED H-11" W-4.5"

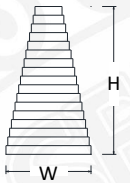

PEJ H-10" W-5.75"

PEK H-7.5" W-5"



PEO H-16.5" W-14"

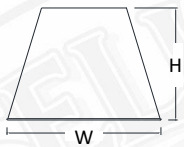

PER H-10.5" W-14.5"

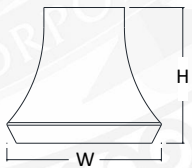

PEV H-14.25" W-16.25"



MPA H-14" W-5.5"



PEF H-13" W-12"



PEOB H-12" W-7"

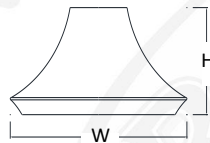

PES H-11.75" W-22.5"

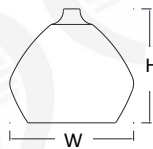

PEX H-11" W-12"

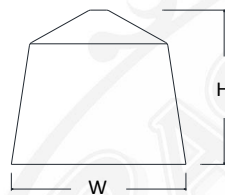

PEY H-16.75" W-19"



PEZ H-14.5" W-9.75"

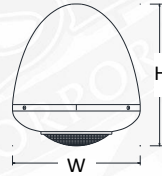

PEG H-11" W-10"



PEP H-15" W-18"

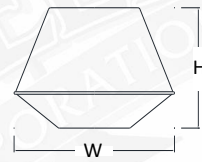

PET H-12" W-18"

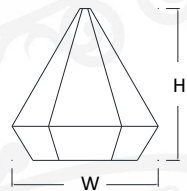

DMD10 H-14.5" W-14"

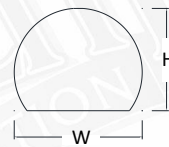

TD8 H-6.625" W-8"

TD10 H-8" W-10"

TD12 H-9.375" W-12"

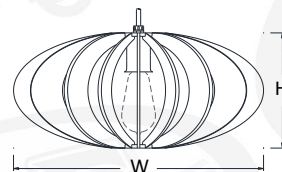

BON18 H-8.5" W-18.5"

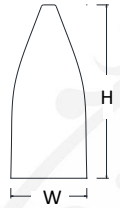

PEH H-13.25" W-6"

PEI H-21" W-5.25"



PEQ H-13.5" W-16"

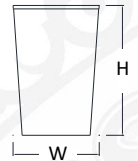

PEU H-9.5" W-14.25"



SQB618 H-18" W-6"



S1 H-2.625" W-2"



C - MOUNTING OPTIONS

D - MOUNTING ADD-ONS

STEM MOUNT

*STEMS RATED FOR DAMP LOCATION * 1/4" NPT AND 3/4" NPT AVAILABLE UPON REQUEST



ST(XX) STEM- 1/2" NPT
XX = LENGTH OF STEM
(EXAMPLE - "ST18" = STEM MOUNT 18" LENGTH)
*CANOPY NOT INCLUDED, ADD IN SECTION D

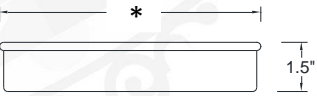

CNK CANOPY For MULTIPLE FIXTURES
*CNK dimensions vary on number of fixtures applied

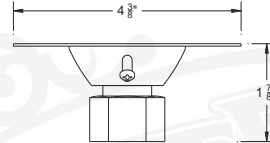

SLC 1/2" SLOPE CEILING CANOPY 1/2"
*(Slopes To 20 Degrees)

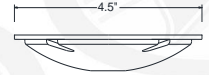

STC 1/2" 1/2" STEM MOUNT CANOPY

INCANDESCENT CORD MOUNTS

*INCANDESCENT MAX WATTAGE 150 WATT. CALL FACTORY FOR HIGHER WATTAGES. LOOPS, CABLES, AND CHAINS AVAILABLE ONLY FOR INCANDESCENT *CORDS RATED FOR DRY LOCATION *CANOPY DIMENSIONS: 2" (H) 5.75" (W)



MCB 8' BLACK CORD
MCW 8' WHITE CORD



MTCB 8' BLACK CORD, CABLE, and LOOP
MTCW 8' WHITE CORD, CABLE, and LOOP



MTCHB 8' BLACK CORD, 3' CHAIN, and LOOP
MTCHW 8' WHITE CORD, 3' CHAIN, and LOOP



MTLB 8' BLACK TELEPHONE CORD AND CABLE
MTLW 8' WHITE TELEPHONE CORD AND CABLE



MRCB 8' BLACK CORD, CABLE, and LOOP
MRCW 8' WHITE CORD, CABLE, and LOOP



MRCHB 8' BLACK CORD, 3' CHAIN, and LOOP
MRCHW 8' WHITE CORD, 3' CHAIN, and LOOP



MFHB 8' BLACK CORD WITH FLAT HUB
MFHW 8' WHITE CORD WITH FLAT HUB

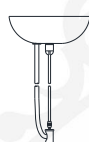

MCBLC 8' BLACK CORD and CABLE
MCWLC 8' WHITE CORD and CABLE



MCHB 8' BLACK CORD, 3' CHAIN, and LOOP
MCHW 8' WHITE CORD, 3' CHAIN, and LOOP
* Loop may vary due to shade style

F – LIGHT SOURCE

BASELITE'S PUBLISHED LUMINAIRE PHOTOMETRIC TESTING WAS PERFORMED IN A 3-METER INTEGRATING SPHERE USING THE 4TT GEOMETRY METHOD. DATA IS CONSIDERED TO BE REPRESENTATIVE OF THE CONFIGURATIONS SHOWN, WITHIN THE TOLERANCES ALLOWED BY LIGHTING FACTS. TO OBTAIN AN IES FILE SPECIFIC TO YOUR PROJECT, PLEASE CONTACT THE FACTORY.

INCANDESCENT (INC) MED E26

INC 100W (MAX) - 3TD, 3PEH, 3PE, PEZ, S1, TD8, TD10, TD12, MPA, BON18
INC 150W (MAX) - PEA, PEB, PEC, PED, PEF, PEG, PEH, PEI, PEJ, PEK, PEO, PEP, PEQ, PER, PES, PET, PEU, PEV, PEX, PEY, PEZ, DMD10, SQB618, WRO, WRO1, WRO2, PEHD615

*IMPORTANT – FOR LIGHT EMITTED DIODE (LED) LIGHT SOURCE OPTION, FIXTURES ARE LIMITED DUE TO SIZE OF THE SIZE OF THE DRIVER. **EXAMPLE: / 150INC /**

OPTION	WATTAGE	LUMENS	CRI	VOLTAGE	DIMMING
100INC	100W	PER BULB SPECS	>90	120-277 VAC	N/A
150INC	150W	PER BULB SPECS	>90	120-277 VAC	N/A