



# BASELITE – MODERN PENDANTS – LED – SPEC SHEET



PROJECT NAME: \_\_\_\_\_ PROJECT TYPE: \_\_\_\_\_

MODEL #	/	/	/	/	/	/	/	/	/	X	X	X
	A	B	C	D	E	F	G	H	I	J	K	
EXAMPLE:	3TD	80-59-81	BLC	CNK	41	25WLED	35K	LDM120	-	-	-	

\*SKIP SECTION IF OPTION DOES NOT APPLY

NOTES:

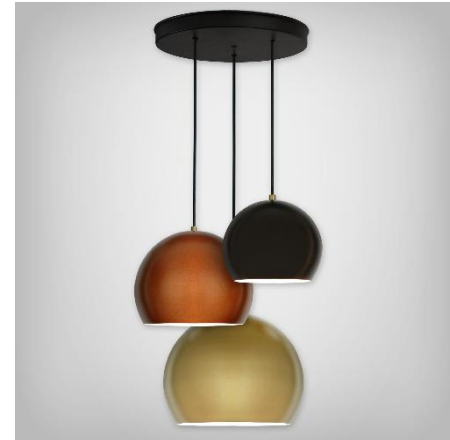

## A - SHADES

### MODERN PENDANTS

- 3TD – 3-25WLED (MAX)
- 3PEH – 3-25WLED (MAX)
- 3PE – 3-25WLED (MAX)
- PEA – 25WLED (MAX)
- PEB – 25WLED (MAX)
- PEC – 25WLED (MAX)
- PED – 25WLED (MAX)
- PEF – 25WLED (MAX)
- PEG – 25WLED (MAX)
- PEH – 25WLED (MAX)
- PEI – 25WLED (MAX)
- PEJ – 25WLED (MAX)
- PEK – 25WLED (MAX)
- PEO – 35WLED (MAX)
- PEOB – 25WLED (MAX)
- PEP – 35WLED (MAX)
- PEQ – 35WLED (MAX)
- PER – 25WLED (MAX)
- PES – 25WLED (MAX)
- PET – 25WLED (MAX)
- PEU – 25WLED (MAX)
- PEV – 25WLED (MAX)
- PEY – 80WLED (MAX)
- PEX – 25WLED (MAX)
- PEZ – 25WLED (MAX)
- DMD10 - 25WLED (MAX)
- SQB618 - 25WLED (MAX)
- S1 – N/A (LED LAMP ONLY)
- TD8 - 25WLED (MAX)
- TD10 - 25WLED (MAX)
- TD12 - 25WLED (MAX)
- PEHD615 - 25WLED (MAX)
- MPA - 25WLED (MAX)

## B - FINISH OPTIONS

(SEE WEBSITE FOR SWATCH COLORS)  
 (\*\*SEE NOTES FOR LIMITATIONS\*)  
 14, 15, 16, 17, 18, 19, 19P, 20, 20P, 20PB,  
 20SB, 21, 21P, 22, 22P, 23, 23P, 38, 39, 40,  
 41, 41.5, 42, 43, 44, 45, 46, 48, 49, 50, 51,  
 52, 53, 54, 55, 57, 58, 59, 60, 61, 62, 63, 64,  
 65, 66, 70, 71, 72, 73, 74, 75, 76, 77, 78, 79,  
 80, 81, 82, 83, 84, 85, 86, 87, 88, 89, 90, 91,  
 92, 93, 94, 95, 96, 97, 98, 99, 100, MG.

## C – MOUNTING OPTIONS

**LED CORD MOUNT**  
 LBLC, LWHC, LTCB, LTCW, LTCHB, LTCHW,  
 LTLB, LTLW, LTLB, LTLW, LRCB, LRCW,  
 LRCHB, LRCHW, LFHB, LFHW, LHBLC,  
 LHWHC, LCBLC, LCWHC, LCHB, LCHW

**STEM MOUNT (INC)**  
 ST6, ST12, ST18, ST24, ST36, ST48, STXX

## D – MOUNTING ADD-ONS

**INC ADD-ONS**  
 CNK – MULTIPLE FIXTURE CANOPY  
 STC – STEM MOUNT CANOPY  
 SLC1/2” – SLOPE CEILING CANOPY ½”

## E – MOUNTING COLOR

SEE SECTION “B” FOR COLOR OPTIONS.

## F – LIGHT SOURCE

(SEE PAGE 3 FOR WATTAGE LIMITATIONS)  
**LIGHT EMITTED DIODE (LED)**  
 10W, 12W, 25W

\*NOTE – MAX WATTAGE IS LISTED NEXT TO THE  
 SHADE MODEL NUMBER IN SECTION “A”. ALL  
 WATTAGES BELOW THAT ARE ALSO AVAILABLE FOR  
 THE SAME MODEL NUMBER.

## G – LED COLOR TEMP

- 27K – 2700 K
- 3K – 3000 K
- 35K – 3500 K
- 4K – 4000 K
- 5K – 5000 K

## H – ELECTRICAL OPTION

(SEE PAGE 3 FOR DIMMING OPTION  
 SPECIFICATIONS)  
**LDM120**  
**LDM0-10**

## I – GLASS OPTIONS

CALL FACTORY FOR REQUEST.

## J – ACCESSORIES

CALL FACTORY FOR REQUEST.

## K – ACCESSORY COLOR

SEE SECTION “B” FOR COLOR OPTIONS.

## NOTES

- (1). FINISH OPTIONS 20, 21, 22, 23 ARE FOR SOLID BRASS FIXTURES ONLY.
  - (2). FINISH OPTIONS 19, 21, 22, 23, 75, 76, 77, 83, 84, 88, 93 AND 98 ARE APPLIED BY HAND. THESE FINISHES WILL VARY IN CONSISTENCY.
  - (3). FINISH OPTIONS FOR SHADES ≤ 10” IN DIAMETER ARE THE SAME INSIDE AND OUT OF FIXTURE. SHADES > 10” IN DIAMETER ARE WHITE ON THE INSIDE.
  - (4). FINISH OPTIONS 19, 38, 39, 40, 49, 54, 57, 58, 61, 62, 63, 70, 71, 72, 73, 78, 83, 84, 88, 92, 93, 98 ONLY AVAILABLE INSIDE AND OUT OF FIXTURE. OTHER FINISHES ARE WHITE INSIDE.
  - (5). FINISH OPTIONS 61, 62, 70, 71, 72, 73 ARE FINISHED WITH A SUPERCHROME ON THE INSIDE FOR ALL LED LIGHT SOURCE OPTIONS.
  - (6). COLOR CORDS ARE NOT APPLICABLE FOR LED OPTIONS.
- \*ALL FIXTURES MOUNT TO A 4-O JUNCTION BOX.  
 \*FIXTURE DIMENSIONS MAY VARY ± 0.25.

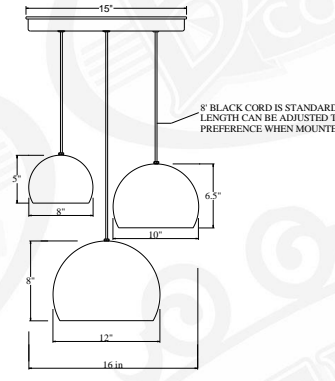

**3TD H-TBD W-16”**



**PEA H-15” W-8.75”**

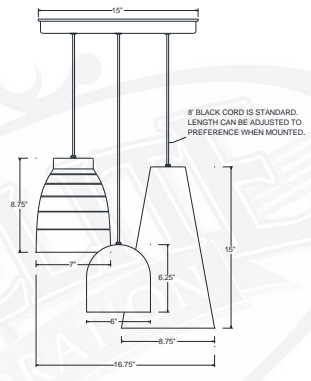

**3PE H-TBD W-16.75”**



**PEB H-6.25” W-6”**

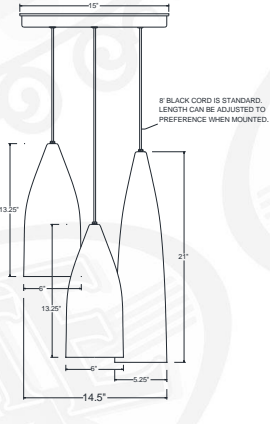

**3PEH H-TBD W-14.5”**

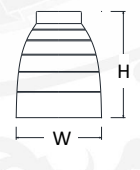

**PEC H-8.75” W-7”**

## A - SHADES



**PED** H-11" W-4.5"



**PEF** H-13" W-12"

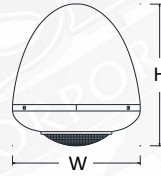

**PEG** H-11" W-10"

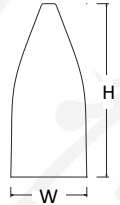

**PEH** H-13.25" W-6"  
**PEI** H-21" W-5.25"

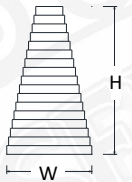

**PEJ** H-10" W-5.75"  
**PEK** H-7.5" W-5"



**PEOB** H-12" W-7"



**PEP** H-15" W-18"



**PEQ** H-13.5" W-16"



**PEO** H-16.5" W-14"

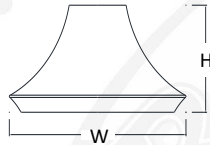

**PES** H-11.75" W-22.5"

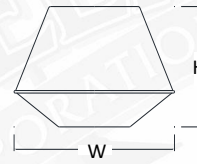

**PET** H-12" W-18"



**PEU** H-9.5" W-14.25"

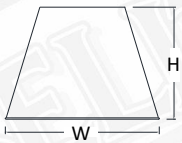

**PER** H-10.5" W-14.5"

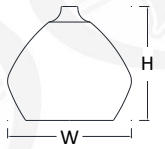

**PEX** H-11" W-12"

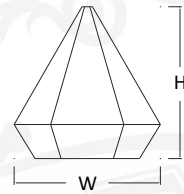

**DMD10** H-14.5" W-14"



**SQB618** H-18" W-6"

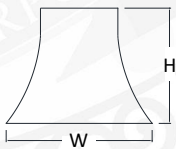

**PEV** H-16.5" W-13"

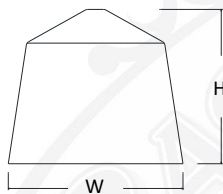

**PEY** H-16.75" W-19"

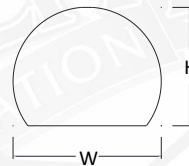

**TD8** H-6.625" W-8"

**TD10** H-8" W-10"

**TD12** H-9.375" W-12"

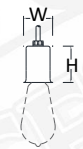

**S1** H-2.625" W-2"



**MPA** H-14" W-5.5"

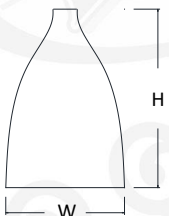

**PEZ** H-14.5" W-9.75"





**C - MOUNTING OPTIONS**

**D - MOUNTING ADD-ONS**

**STEM MOUNT**

\*STEMS RATED FOR DAMP LOCATION \* 1/4" NPT AND 3/4" NPT AVAILABLE UPON REQUEST



**ST(XX)** STEM- 1/2"  
XX = LENGTH OF STEM  
(EXAMPLE - "ST18" = STEM MOUNT 18" LENGTH)  
\*CANOPY NOT INCLUDED, ADD IN SECTION D

**MOUNTING ADD-ON**



**CNK** CANOPY For MULTIPLE FIXTURES

\*CNK dimensions vary on number of fixtures applied

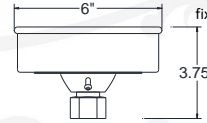

**LSLC 1/2"** SLOPE CEILING CANOPY 1/2"

\*(Slopes To 20 Degrees)

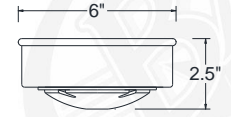

**LSTC 1/2"** 1/2" STEM MOUNT CANOPY

**LED CORD MOUNTS**

FOR LED & COMPACT FLUORESCENT OPTIONS, CANOPIES WILL VARY IN SIZE DUE TO SIZE OF THE DRIVER/BALLAST THAT WILL BE LOCATED INSIDE OF THE CANOPY. \*CORDS RATED FOR DRY LOCATION  
\*CANOPY DIMENSIONS: 4" (H) 5.5" (W)



**BLC** 8' BLACK CORD  
**WHC** 8' WHITE CORD



**LTCB** 8' BLACK CORD, CABLE, and LOOP  
**LTCW** 8' WHITE CORD, CABLE, and LOOP



**LTCHB** 8' BLACK CORD, 3' CHAIN, and LOOP  
**LTCHW** 8' WHITE CORD, 3' CHAIN, and LOOP

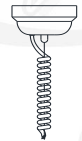

**LTLB** 8' BLACK TELEPHONE CORD AND CABLE  
**LTLW** 8' WHITE TELEPHONE CORD AND CABLE

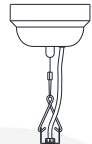

**LRCB** 8' BLACK CORD, CABLE, and LOOP  
**LRCW** 8' WHITE CORD, CABLE, and LOOP



**LRCHB** 8' BLACK CORD, 3' CHAIN, and LOOP  
**LRCHW** 8' WHITE CORD, 3' CHAIN, and LOOP



**LFHB** 8' BLACK CORD WITH FLAT HUB  
**LFHW** 8' WHITE CORD WITH FLAT HUB



**LCBLC** 8' BLACK CORD and CABLE  
**LCWHC** 8' WHITE CORD and CABLE



**LCHB** 8' BLACK CORD, 3' CHAIN, and LOOP  
**LCHW** 8' WHITE CORD, 3' CHAIN, and LOOP  
\* Loop may vary due to shade style

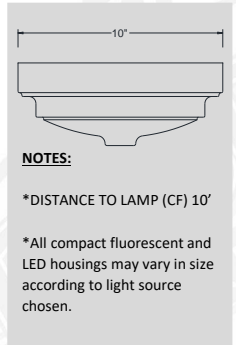

**NOTES:**

\*DISTANCE TO LAMP (CF) 10"

\*All compact fluorescent and LED housings may vary in size according to light source chosen.

**F - LIGHT SOURCE**

BASELITE'S PUBLISHED LUMINAIRE PHOTOMETRIC TESTING WAS PERFORMED IN A 3-METER INTEGRATING SPHERE USING THE 4TT GEOMETRY METHOD. DATA IS CONSIDERED TO BE REPRESENTATIVE OF THE CONFIGURATIONS SHOWN, WITHIN THE TOLERANCES ALLOWED BY LIGHTING FACTS.

**LIGHT EMITTING DIODE (LED)**

**LED 25W (MAX)** - 3TD, 3PEH, 3PE, PELB, PEMB, PENB, TD8, TD10, TD12, PEA, PEB, PEC, PED, PEF, PEG, PEH, PEI, PEJ, PEK, PER, PES, PET, PEU, PEV, PEX, PEZ, DMD10, SQB618, WRO, WRO1, WRO2, PEHD615, MPA  
**LED 35W (MAX)** - PEO, PEP, PEQ  
**LED 80W (MAX)** - PEY

\*IMPORTANT - FOR LIGHT EMITTED DIODE (LED) LIGHT SOURCE OPTION, FIXTURES ARE LIMITED DUE TO SIZE OF THE FIXTURE AND THE CORD WATTAGE RESTRICTIONS. PLEASE SEE MAX WATTAGE AVAILABILITY.

EXAMPLE: / LED25W /

OPTION	WATTAGE	LUMENS	CRI	VOLTAGE	DIMMING
LED10WF	10W	1280	>90	120-277 VAC	TRI-ELV *120V ONLY
LED12W	12W	1481	>90	120-277 VAC	See section "H"
LED25W	25W	2812	>90	120-277 VAC	See section "H"
LED35W	35W	3743	>90	120-277 VAC	See section "H"
LED80W	80W	8800	>90	120-277 VAC	See section "H"

@3500K

**H - ELECTRICAL OPTION**

MOST BASELITE'S ELECTRICAL OPTIONS ARE ONLY COMPATIBLE FOR CERTAIN FIXTURES. PLEASE SEE NOTES BELOW AND FOR FURTHER DETAILS CONTACT THE FACTORY.

**LED DIMMING OPTIONS**

(LED10WF - ONLY AVAILABLE WITH LDM120 - TRI-ELV DIMMING OPITON) ALL OTHER WATTAGES CAN CHOOSE FROM THE OPTIONS BELOW. CONTACT DRIVER MANUFACTURER FOR FURTHER SPECIFICATIONS.

**LDM120** - TRIAC / ELV - INPUT 120 / 277V - DIMMING AT 120 VOLT ONLY  
**LDM0-10V** - 0 - 10V - DIMMING AT 120 / 277 VOLTS