



BASELITE – FA-FAP – LED – SPECIFICATION SHEET



PROJECT NAME: _____ PROJECT TYPE: _____

MODEL #	/	/	/	/	/	/	/	/	/	X	/	/
	A	B	C	D	E	F	G	H	I	J	K	
EXAMPLE:	FAP22	41	ST24	SLC1/2"	43	45W	3K	LDM120		GR13	44	

*SKIP SECTION IF OPTION DOES NOT APPLY

NOTES:



FAP22/62/CBLC/300INC

A - SHADES

- FA SERIES**
FA12 - 25WLED (MAX)
FA16 - 50WLED (MAX)
FA22 - 100WLED (MAX)
- FAP SERIES**
FAP12 - 25WLED (MAX)
FAP16 - 50WLED (MAX)
FAP22 - 100WLED (MAX)

B - FINISH OPTIONS

(SEE WEBSITE FOR SWATCH COLORS)
(*SEE NOTES FOR LIMITATIONS*)
21P, 41, 41.5, 43, 44, 48, 51, 52, 53, 58, 59, 61, 62, 74, 79, 97, 99, 100, MG.

C - MOUNTING OPTIONS

- CORD MOUNT**
LBLC - 8' black cord & canopy
LWHC - 8' white cord & canopy
LTCB - 8' black cord, loop, cable & canopy
LTCW - 8' white cord, loop, cable & canopy
LTLB - 8' black telephone cable
LTLW - 8' white telephone cable
LCBLC - 8' black cord, cable and canopy
LCWHC - 8' white cord, cable and canopy
3LCBLC - 3 cable and 8' black cord & canopy
3LCBLW - 3 cable and 8' white cord & canopy
HKLBC - hook and 8' black cord & canopy
HKLWC - hook and 8' white cord & canopy
- STEM MOUNT**
ST18 - 18" stem
ST24 - 24" stem
ST36 - 36" stem
ST48 - 48" stem
STXX - XX = stem length

D - MOUNTING ADD-ONS

- LED ADD-ONS**
LSLC - LED slope ceiling canopy
LSTC - LED stem mount canopy
HB3 - ¾" hub

E - MOUNTING COLOR

SEE SECTION "B" FOR COLOR OPTIONS.

F - LIGHT SOURCE

(SEE PAGE 3 FOR WATTAGE LIMITATIONS)
LIGHT EMITTED DIODE (LED)
10W, 12W, 25W, 35W, 50W, 80W, 100W

*NOTE - MAX WATTAGE IS LISTED NEXT TO THE SHADE MODEL NUMBER IN SECTION "A". ALL WATTAGES BELOW THAT ARE ALSO AVAILBLE FOR THE SAME MODEL NUMBER.

G - LED COLOR TEMP

- 27K** - 2700 KELVIN
3K - 3000 KELVIN
35K - 3500 KELVIN
4K - 4000 KELVIN
5K - 5000 KELVIN

H - ELECTRICAL OPTION

(SEE PAGE 3 FOR DIMMING OPTION SPECIFICATIONS)
LDM120
LDM0-10

I - GLASS OPTIONS

NOT AVAILABLE

J - ACCESSORIES

- LGR12** - 12" louvered grill
LGR16 - 16" louvered grill
LGR22 - 22" louvered grill
FLE12 - 12" flat clear lens w/ clips
FLE16 - 16" flat clear lens w/ clips
FLE22 - 22" flat clear lens w/ clips
BLE12 - 12" flat clear lens w/ band
BLE16 - 16" flat clear lens w/ band
BLE22 - 22" flat clear lens w/ band
LL12 - 12" clear conical lens
LL16 - 16" clear conical lens
LL22 - 22" clear conical lens
CRL12 - 12" clear curved lens
CRL16 - 16" clear curved lens
CRL22 - 22" clear curved lens
DRL16 - 16" clear drop lens
DRL22 - 22" clear drop lens
BRS16 - 16" aluminum bottom ring
BRS22 - 22" aluminum bottom ring
TRS16 - 16" aluminum top ring
TRS22 - 22" aluminum top ring
FWG16 - 16" full wire grill
FWG22 - 22" full wire grill

K - ACCESSORY COLOR

SEE SECTION "B" FOR COLOR OPTIONS.

NOTES

- (1). FINISH OPTIONS 20, 21, 22, 23 ARE FOR SOLID BRASS FIXTURES ONLY.
- (2). FINISH OPTIONS 19, 21, 22, 23, 75,76, 77, 83, 84, 88, 93 AND 98 ARE APPLIED BY HAND. THESE FINISHES WILL VARY IN CONSISTENCY.
- (3). FINISH OPTIONS 19, 38, 39, 40, 49, 54, 57, 58, 61, 62, 63, 70, 71, 72, 73, 78, 83, 84, 88, 92, 93, 98 ONLY AVAILABLE INSIDE AND OUT OF FIXTURE. OTHER FINISHES ARE WHITE INSIDE.
- (4). FINISH OPTIONS 61, 62, 70, 71, 72, 73 ARE FINISHED WITH A SUPERCHROME ON THE INSIDE FOR ALL LED LIGHT SOURCE OPTIONS.
*ACCORDING TO THE LIGHT SOURCE THE BACKPLATE MAY VARY IN SIZE.
(EXAMPLE: LED LIGHT SOURCE WILL HAVE A DEEPER BACKPLATE TO HOUSE THE DRIVER.)
*ALL FIXTURES MOUNT TO A 4-0 JUNCTION BOX.
*FIXTURE DIMENSIONS MAY VARY ± 0.25.

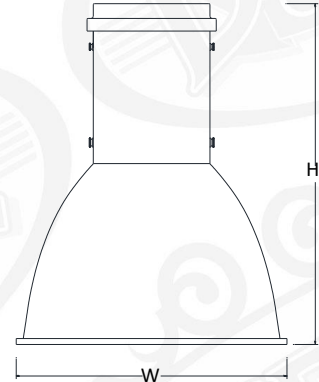

	HEIGHT	WIDTH
FAP12	H-13.5"	W-12"
FAP16	H-20.25"	W-16"
FAP22	H-23.5"	W-22"

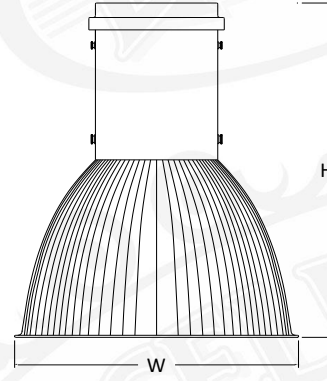

	HEIGHT	WIDTH
FA12	H-13.5"	W-12"
FA16	H-17.5"	W-16"
FA22	H-22"	W-22"



C – MOUNTING OPTIONS

LED CORD MOUNTS

*FOR LED & COMPACT FLUORESCENT OPTIONS, CANOPIES WILL VARY IN SIZE DUE TO SIZE OF THE DRIVER/BALLAST THAT WILL BE LOCATED INSIDE OF THE CANOPY. *CORDS RATED FOR DRY LOCATION *CANOPY DIMENSIONS: 4" (H) 5.5" (W)
*CORD AND CANOPY COME IN THE SAME COLOR.



LCBLC 8' BLACK CORD, CABLE & CANOPY
LCWHC 8' WHITE CORD, CABLE & CANOPY



LTLB 2.5' BLACK TELEPHONE CABLE & CANOPY
LTLW 2.5' WHITE TELEPHONE CABLE & CANOPY



LTCB 8' CABLE, BLACK CORD, LOOP & CANOPY
LTCW 8' CABLE, WHITE CORD, LOOP & CANOPY



LBLC 8' BLACK CORD AND CANOPY
LWHC 8' WHITE CORD AND CANOPY

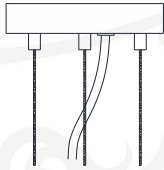

3LCBLC 3 CABLE, BLACK CORD & CANOPY
3LCWHC 3 CABLE, WHITE CORD & CANOPY



HKLBC 3/4" HOOK WITH 8' BLACK CORD & CANOPY
HKLWC 3/4" HOOK WITH 8' WHITE CORD & CANOPY

STEM MOUNTS

*STEMS ARE RATED FOR DAMP LOCATION



STEM- 1/2" NPT
ST(XX) STEM- 3/4" NPT
XX = LENGTH OF STEM
(EXAMPLE – "ST18" = STEM MOUNT 18" LENGTH)
*CANOPY NOT INCLUDED, ADD IN SECTION D

D - MOUNTING ADD-ONS

LED MOUNTING ADD-ONS

* FOR LED & COMPACT FLUORESCENT OPTIONS, CANOPIES WILL VARY IN SIZE DUE TO SIZE OF THE DRIVER/BALLAST THAT WILL BE LOCATED INSIDE OF THE CANOPY.

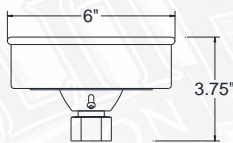

LSLC LED SLOPE CEILING CANOPY
*(Slopes To 20 Degrees)

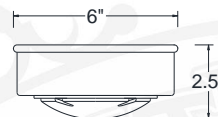

LSTC LED STEM MOUNT CANOPY



HB3 - 3/4" HUB



F – LIGHT SOURCE

BASELITE'S PUBLISHED LUMINAIRE PHOTOMETRIC TESTING WAS PERFORMED IN A 3-METER INTEGRATING SPHERE USING THE 4TT GEOMETRY METHOD. DATA IS CONSIDERED TO BE REPRESENTATIVE OF THE CONFIGURATIONS SHOWN, WITHIN THE TOLERANCES ALLOWED BY LIGHTING FACTS. TO OBTAIN AN IES FILE SPECIFIC TO YOUR PROJECT, PLEASE CONTACT THE FACTORY.

LIGHT EMITTING DIODE (LED)

LED 25W (MAX)- FA12, FAP12
LED 50W (MAX)- FA16, FAP16
LED 100W (MAX)- FA22, FAP22

***IMPORTANT** – FOR LIGHT EMITTED DIODE (LED) LIGHT SOURCE OPTION, FIXTURES ARE LIMITED DUE TO SIZE OF THE FIXTURE AND THE CORD WATTAGE RESTRICTIONS. PLEASE SEE MAX WATTAGE AVAILABILITY. **EXAMPLE:** / LED80W /

OPTION	WATTAGE	LUMENS	CRI	VOLTAGE	DIMMING
LED10W	10W	1570	>90	120-277 VAC	TRI-ELV *120V ONLY
LED12W	12W	1596	>90	120-277 VAC	See section "H"
LED25W	25W	3125	>90	120-277 VAC	See section "H"
LED35W	35W	4200	>90	120-277 VAC	See section "H"
LED50W	50W	5750	>90	120-277 VAC	See section "H"
LED80W	80W	8800	>90	120-277 VAC	See section "H"
LED100W	100W	10500	>90	120-277 VAC	See section "H"
@3500K					

H – ELECTRICAL OPTION

MOST BASELITE'S ELECTRICAL OPTIONS ARE ONLY COMPATIBLE FOR CERTAIN FIXTURES. PLEASE SEE NOTES BELOW AND FOR FURTHER DETAILS CONTACT THE FACTORY. FOR DIMMING BALLAST OPTION, PLEASE CHOOSE MARK X OR MARK VII, SO RESTRICTIONS APPLY DUE TO THE SIZE OF THE BALLAST AND FIXTURE.

LED DIMMING OPTIONS

(LED10WF – ONLY AVAILABLE WITH **LDM120** - TRI-ELV DIMMING OPITON) ALL OTHER WATTAGES CAN CHOOSE FROM THE OPTIONS BELOW. CONTACT DRIVER MANUFACTURER FOR FURTHER SPECIFICATIONS.

LDM120 - TRIAC / ELV – INPUT 120 / 277V - DIMMING AT 120 VOLT ONLY
LDM0-10V – 0 – 10V – DIMMING AT 120 / 277 VOLTS

J – ACCESSORIES

*NOTE: MUST USE TEMPERED GLASS FOR LIGHT FIXTURES USING HIGH INTENSITY DISCHARGE (HID) LIGHT SOURCE OPTION.

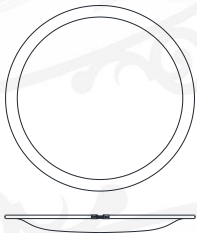

CRL12 - 12" CLEAR CURVED LENS
CRL16 - 16" CLEAR CURVED LENS
CRL22 - 22" CLEAR CURVED LENS

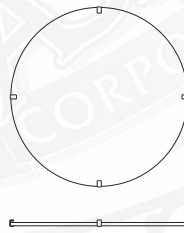

FLE12 - 12" FLAT CLEAR LENS WITH CLIPS
FLE16 - 16" FLAT CLEAR LENS WITH CLIPS
FLE22 - 22" FLAT CLEAR LENS WITH CLIPS



BLE12 12" FLAT CLEAR LENS WITH BAND
BLE16 16" FLAT CLEAR LENS WITH BAND
BLE22 22" FLAT CLEAR LENS WITH BAND



J – ACCESSORIES (CONT'D)

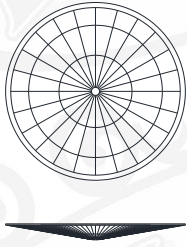

LL12 12" CLEAR CONICAL LENS
LL16 16" CLEAR CONICAL LENS
LL22 22" CLEAR CONICAL LENS

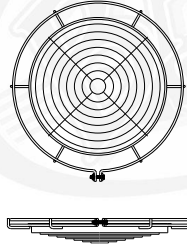

LGR12 12" LOUVERED GRILL
LGR16 16" LOUVERED GRILL
LGR22 22" LOUVERED GRILL

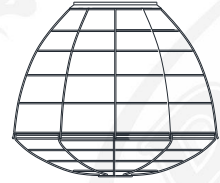

FWG16 - 16" FULL WIRE GRILL
FWG22 - 22" FULL WIRE GRILL

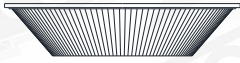

DRL16 - 16" PRISMATIC DROP LENS
DRL22 - 22" PRISMATIC DROP LENS



TRS16 - 16" TOP RING ALUMINUM SHIELD
TRS22 - 22" TOP RING ALUMINUM SHIELD



BRS16 - 16" BOTTOM RING ALUMINUM SHIELD
BRS22 - 22" BOTTOM RING ALUMINUM SHIELD