



BASELITE – CRAFTSMAN – INC – SPECIFICATION SHEET



PROJECT NAME: _____ PROJECT TYPE: _____

MODEL #	/	/	/	/	/	/	/	/	/	X	X
	A	B	C	D	E	F	G	H	I	J	K
EXAMPLE:	CR13	86	WMD81	-	-	25W	3K	LDM120	PR3	-	-

*SKIP SECTION IF OPTION DOES NOT APPLY

NOTES:



A - SHADES

CRAFTSMAN
CR13 - 100WINC (MAX)
CR20 - 200WINC (MAX)

B - FINISH OPTIONS

(SEE WEBSITE FOR SWATCH COLORS)
 (*SEE NOTES FOR LIMITATIONS*)
 14, 15, 16, 17, 18, 19, 19P, 20, 20P, 20PB, 20SB, 21, 21P, 22, 22P, 23, 23P, 38, 39, 40, 41, 41.5, 42, 43, 44, 45, 46, 48, 49, 50, 51, 52, 53, 54, 55, 57, 58, 59, 60, 61, 62, 63, 64, 65, 66, 70, 71, 72, 73, 74, 75, 76, 77, 78, 79, 80, 81, 82, 83, 84, 85, 86, 87, 88, 89, 90, 91, 92, 93, 94, 95, 96, 97, 98, 99, 100, MG.

C – MOUNTING OPTIONS

½" ARM EXTENSIONS
 E1, E2, E3, E4, B1
¾" ARM EXTENSIONS
 E3A, E4A, E5, E6, E7, E8, E9, E10, E11, E12, E13, B15, B15S, E19, E20, E21, E25
E14 - CREATE YOUR OWN
 (BASELITE WILL TAKE YOUR SKETCH AND FABRICATE A CUSTOM ARM EXTENSION TO MEET YOUR NEEDS).
½" WALL MOUNT
 B13, WM13, WM13R, WM13X, B10, B11, B101
¾" WALL MOUNT
 B9, B9C, B12, WM14, WM14X, WM15, WM18, WM35, WM35X, WM55, WM55X, WM60, WM60X, WM61, WM61X, WM70, WM70X, WM71, WM71X, WMD81, WMU81
POST MOUNT
 *OTHER POST MOUNTS AVAILABLE. SEE WEBSITE FOR OPTIONS
 PM80, PMD80, PMD81
CORD MOUNT (INC)
 BLC, WHC, TCB, TCW, TCHB, TCHW, TLB, TLW, TLW, RCB, RCW, RCHB, RCHW, FHB, FHW, CBLC, CWHC, CHB, CHW
STEM MOUNT
 ST6, ST12, ST18, ST24, ST36, ST48, STXX

D – MOUNTING ADD-ONS

INC ADD-ONS
 CB1/2", CB3/4", CBC1/2", CBC3/4", SLC1/2" SLC3/4" STC1/2"
UNIVERSAL ADD-ONS
 FH ½", FH ¾", TRB ½", TRB ¾", LGSWL

E – MOUNTING COLOR

SEE SECTION "B" FOR COLOR OPTIONS.

F – LIGHT SOURCE

(SEE PAGE 4 FOR WATTAGE LIMITATIONS)
INCANDESCENT (INC)
 100W, 150W, 200W

G – LED COLOR TEMP

NOT AVAILABLE

H – ELECTRICAL OPTION

NOT AVAILABLE

I – GLASS OPTIONS

CL3, CL4, CLT3, CLT4, BL3, BL4, RE3, RE4, GR3, GR4, AH3, AH4, FR3, FR4, FRT3, FRT4, PR3, PR4, BA, BAX, BAF, PR8, PR8F, FN, OC

J – ACCESSORIES

NOT AVAILABLE

K – ACCESSORY COLOR

NOT AVAILABLE

NOTES

- (1). FINISH OPTIONS 20, 21, 22, 23 ARE FOR SOLID BRASS FIXTURES ONLY.
 - (2). FINISH OPTIONS 19, 21, 22, 23, 75, 76, 77, 83, 84, 88, 93 AND 98 ARE APPLIED BY HAND. THESE FINISHES WILL VARY IN CONSISTENCY.
 - (3). FINISH OPTIONS 19, 38, 39, 40, 49, 54, 57, 58, 61, 62, 63, 70, 71, 72, 73, 78, 83, 84, 88, 92, 93, 98 ONLY AVAILABLE INSIDE AND OUT OF FIXTURE. OTHER FINISHES ARE WHITE INSIDE.
 - (4). FINISH OPTIONS 61, 62, 70, 71, 72, 73 ARE FINISHED WITH A SUPERCHROME ON THE INSIDE FOR ALL LED LIGHT SOURCE OPTIONS.
 - (5). COLOR CORDS ARE NOT APPLICABLE FOR LED OPTIONS.
- *ALL ARMS COME WITH A CAST BACKPLATE (CB1/2", CB3/4", LWTM, CFWTM, ECT.).
 *ACCORDING TO THE LIGHT SOURCE THE BACKPLATE MAY VARY IN SIZE. (EXAMPLE: LED LIGHT SOURCE WILL HAVE A DEEPER BACKPLATE TO HOUSE THE DRIVER).
 *ALL FIXTURES MOUNT TO A 4-O JUNCTION BOX.
 *FIXTURE DIMENSIONS MAY VARY ±0.25.
 *CORD AND CANOPY COME IN THE SAME COLOR.

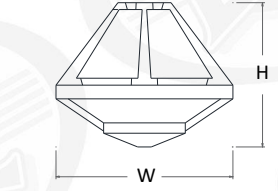

CR13 H - 10.5" W - 13"

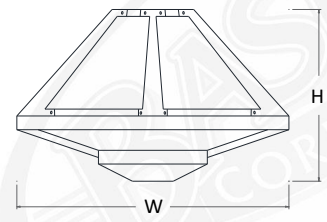

CR20 H - 12.5" W - 20"



C - MOUNTING OPTIONS

1/2" ARM EXTENSIONS

*ARMS RATED FOR WET LOCATION * MAXIMUM SECTIONS OF ARMS ARE DIMENSIONED

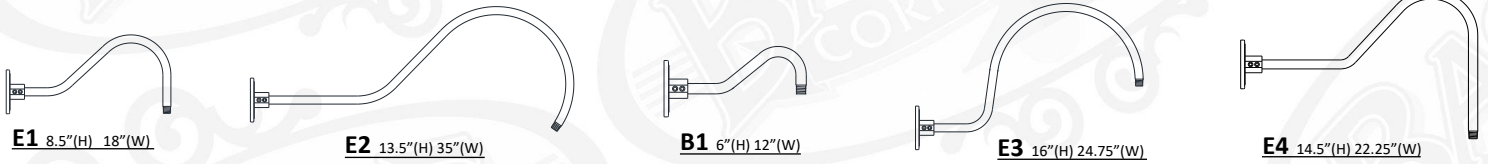

3/4" ARM EXTENSIONS

*ARMS RATED FOR WET LOCATION * MAXIMUM SECTIONS OF ARMS ARE DIMENSIONED

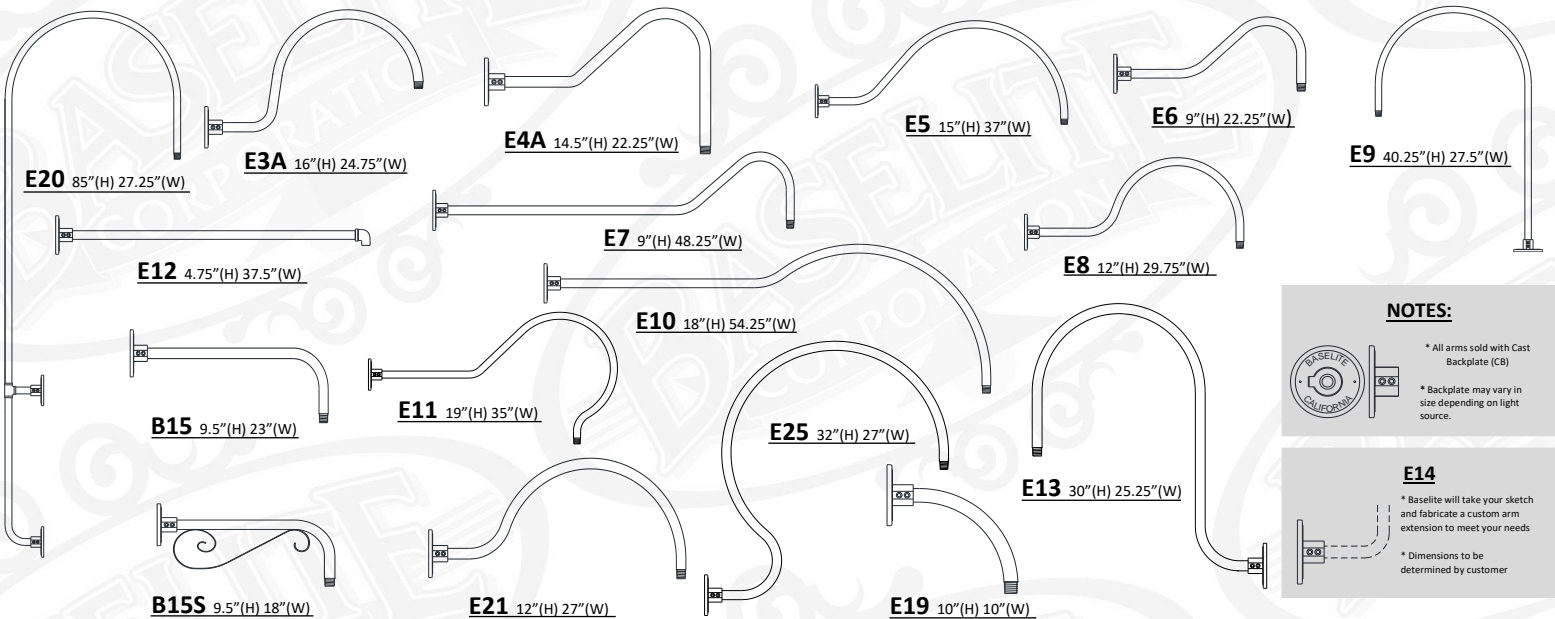

NOTES:



- * All arms sold with Cast Backplate (CB)
- * Backplate may vary in size depending on light source.

E14



- * Baselite will take your sketch and fabricate a custom arm extension to meet your needs
- * Dimensions to be determined by customer

1/2" WALL MOUNTS

*MOUNTS RATED FOR WET LOCATION * MAXIMUM SECTIONS OF MOUNTS ARE DIMENSIONED

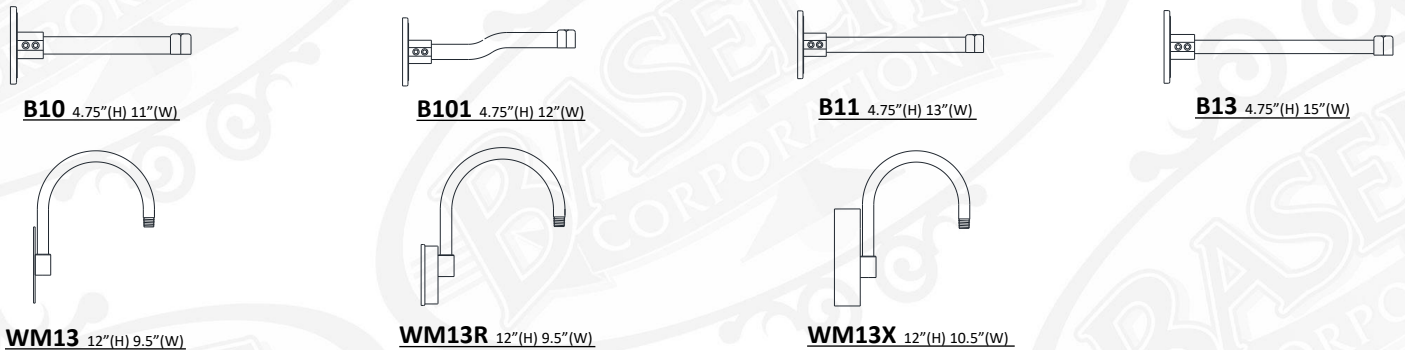

3/4" WALL MOUNTS

*MOUNTS RATED FOR WET LOCATION * MAXIMUM SECTIONS OF MOUNTS ARE DIMENSIONED

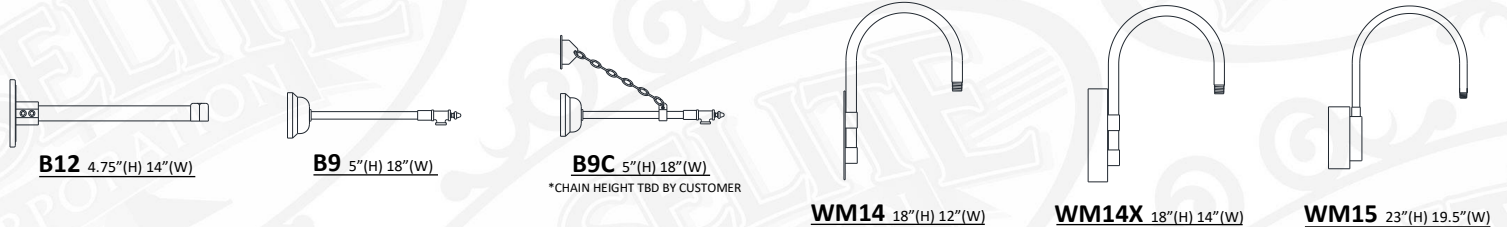



C - MOUNTING OPTIONS (CONTINUED)

3/4" WALL MOUNTS

*MOUNTS RATED FOR WET LOCATION * MAXIMUM SECTIONS OF MOUNTS ARE DIMENSIONED



WM18 30"(H) 20"(W)

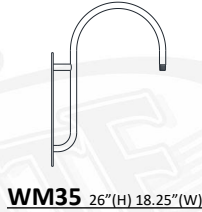

WM35 26"(H) 18.25"(W)



WM35X 26"(H) 22"(W)



WM55 19"(H) 25.5"(W)



WM55X 19"(H) 27"(W)

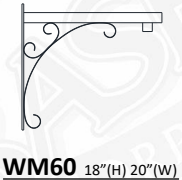

WM60 18"(H) 20"(W)

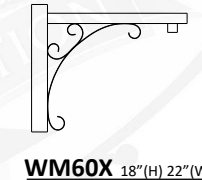

WM60X 18"(H) 22"(W)

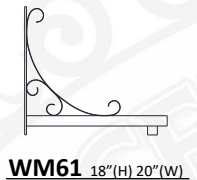

WM61 18"(H) 20"(W)

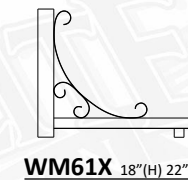

WM61X 18"(H) 22"(W)

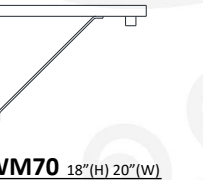

WM70 18"(H) 20"(W)

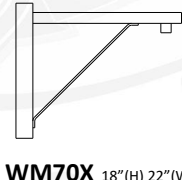

WM70X 18"(H) 22"(W)

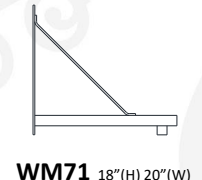

WM71 18"(H) 20"(W)

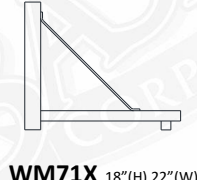

WM71X 18"(H) 22"(W)

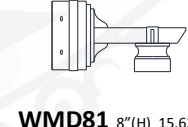

WMD81 8"(H) 15.625"(W)

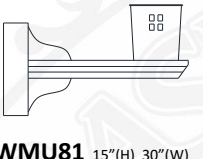

WMU81 15"(H) 30"(W)

POST MOUNTS

*OTHER POST MOUNTS AVAILABLE. PLEASE SEE WEBSITE FOR OPTIONS.

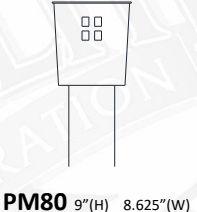

PM80 9"(H) 8.625"(W)

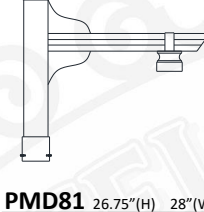

PMD81 26.75"(H) 28"(W)

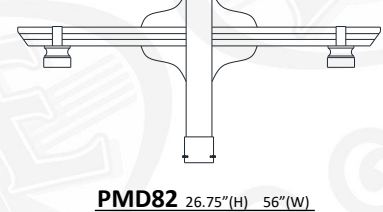

PMD82 26.75"(H) 56"(W)

INCANDESCENT CORD MOUNTS

*INCANDESCENT MAX WATTAGE 150 WATT. CALL FACTORY FOR HIGHER WATTAGES. *LOOPS, CABLES, AND CHAINS AVAILABLE ONLY FOR INCANDESCENT *CORDS RATED FOR DRY LOCATION *CANOPY DIMENSIONS: .625" (H) 5.25" (W)
*CORD AND CANOPY COME IN THE SAME COLOR.

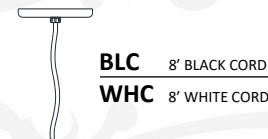

BLC 8' BLACK CORD
WHC 8' WHITE CORD

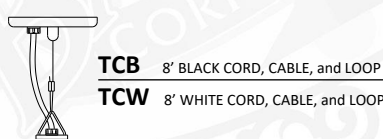

TCB 8' BLACK CORD, CABLE, and LOOP
TCW 8' WHITE CORD, CABLE, and LOOP

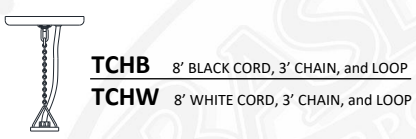

TCHB 8' BLACK CORD, 3' CHAIN, and LOOP
TCHW 8' WHITE CORD, 3' CHAIN, and LOOP

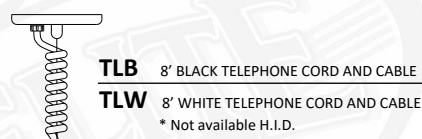

TLB 8' BLACK TELEPHONE CORD AND CABLE
TLW 8' WHITE TELEPHONE CORD AND CABLE
* Not available H.I.D.

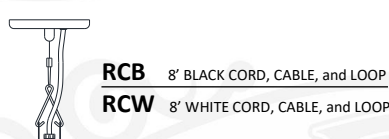

RCB 8' BLACK CORD, CABLE, and LOOP
RCW 8' WHITE CORD, CABLE, and LOOP

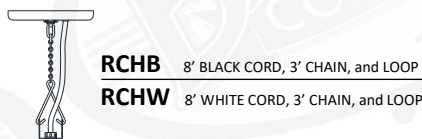

RCHB 8' BLACK CORD, 3' CHAIN, and LOOP
RCHW 8' WHITE CORD, 3' CHAIN, and LOOP

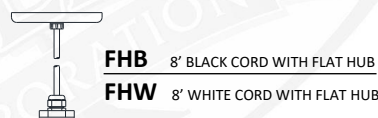

FHB 8' BLACK CORD WITH FLAT HUB
FHW 8' WHITE CORD WITH FLAT HUB

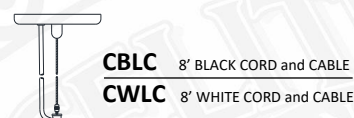

CBLC 8' BLACK CORD and CABLE
CWLC 8' WHITE CORD and CABLE

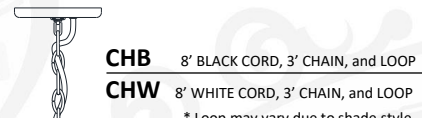

CHB 8' BLACK CORD, 3' CHAIN, and LOOP
CHW 8' WHITE CORD, 3' CHAIN, and LOOP
* Loop may vary due to shade style



C - MOUNTING OPTIONS (CONTINUED)

STEM MOUNTS

*STEMS RATED FOR DAMP LOCATION

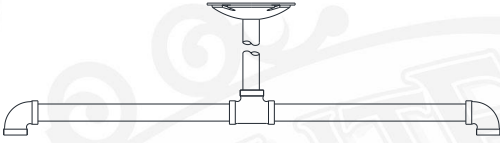

DP24 DOUBLE PENDANT 20"(H) 24"(W)

*DP24 COMES STANDARD WITH STC AND ST18



ST(XX) STEM- 1/2" NPT

XX = LENGTH OF STEM
(EXAMPLE - "ST18" = STEM MOUNT 18" LENGTH)
*CANOPY NOT INCLUDED, ADD IN SECTION D
* 1/4" NPT AND 3/4" NPT AVAILABLE UPON REQUEST



SC24 SCROLL STEM 33"(H) 24"(W)

*SC24 COMES STANDARD WITH STC

D - MOUNTING ADD-ONS

INCANDESCENT ARM ADD-ONS

* FOR LED & COMPACT FLUORESCENT OPTIONS, CANOPIES WILL VARY IN SIZE DUE TO SIZE OF THE DRIVER/BALLAST THAT WILL BE LOCATED INSIDE OF THE CANOPY.

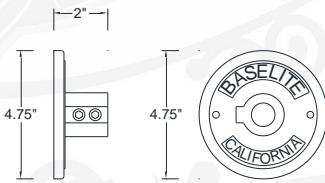

CB 1/2" CAST ALUMINUM BACKPLATE 1/2 NPT

CB 3/4" CAST ALUMINUM BACKPLATE 3/4 NPT

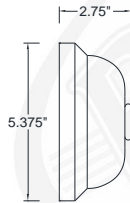

CBC 1/2" 1/2" BACKPLATE COVER

CBC 3/4" 3/4" BACKPLATE COVER

* Includes slip ring to hold 1/2" or 3/4" arm extension in place

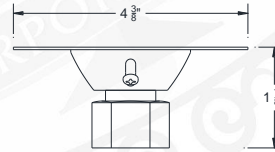

SLC 1/2" SLOPE CEILING CANOPY 1/2"

SLC 3/4" SLOPE CEILING CANOPY 3/4"

*(Slopes To 20 Degrees)



STC 1/2" 1/2" STEM MOUNT CANOPY

UNIVERSAL STEM AND ARM ADD-ONS

* EXAMPLE FOR MULTIPLE MOUNTING ADD-ONS:

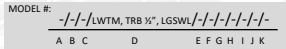

FH 1/2" FLAT HUB 1/2"

FH 3/4" FLAT HUB 3/4"

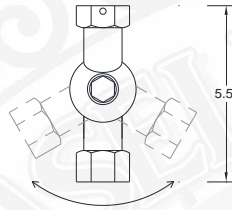

LGSWL 1/2" NPT SWIVEL

For all shades greater than 7" wide in diameter



TRB 1/2"-4' Cable SUPPORT

TRB 3/4"-4' Cable SUPPORT

F - LIGHT SOURCE

INCANDESCENT (INC) MED E26

INC 150W (MAX) - CR13
INC 200W (MAX) - CR20

*IMPORTANT - FOR LIGHT EMITTED DIODE (LED) LIGHT SOURCE OPTION FIXTURES ARE LIMITED DUE TO SIZE OF THE FIXTURE AND THE CORD WATTAGE RESTRICTIONS. PLEASE SEE AVAILABILITY CHART TO THE LEFT.

EXAMPLE: / INC150W /

OPTION	WATTAGE	LUMENS	VOLTAGE	DIMMING
100WINC	100W	PER BULB SPECS	120-277 VAC	PER BULB SPECS
150WINC	150W	PER BULB SPECS	120-277 VAC	PER BULB SPECS
200WINC	200W	PER BULB SPECS	120-277 VAC	PER BULB SPECS



I – GLASS OPTIONS

*NOTE: MUST USE TEMPERED GLASS FOR LIGHT FIXTURES USING HIGH INTENSITY DISCHARGE (HID) LIGHT SOURCE OPTION.



CL3 3" CLEAR GLASS



PR3 3" PRISMATIC GLASS



RE3 3" RED GLASS



BL3 3" BLUE GLASS

CL4 4" CLEAR GLASS

PR4 4" PRISMATIC GLASS

RE4 4" RED GLASS

BL4 4" BLUE GLASS

CLT3 3" CLEAR TEMPERED

CLT4 4" CLEAR TEMPERED



FR3 3" FROSTED GLASS



AH3 3" AMBER HYDE GLASS



GR3 3" GREEN GLASS

FR4 4" FROSTED GLASS

AH4 4" AMBER HYDE GLASS

GR4 4" GREEN GLASS

FRT3 3" FROSTED TEMPERED

FRT4 4" FROSTED TEMPERED

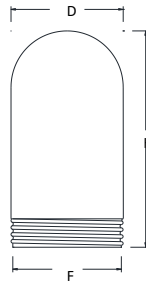

GLASS – DIMENSIONS	
3" GLASS	
Diameter	3.34"
Height	6.93"
Fitter	3.29"
4" GLASS	
Diameter	4.34"
Height	8.37"

GLASS – MAX WATTAGE	
3" GLASS	– 100W INC / LED12W
4" GLASS	– 200W INC / LED25W



BA 6" OPAL BALL
(100W INC MAX/LED12W)



BAX 9" CLEAR GLOBE
BAF 9" FROSTED GLOBE
(200W INC MAX/LED25W)



FN 8" CLEAR TEXTURED GLOBE
(150W INC MAX/LED25W)



BA7 7" CLEAR GLOBE
BA7F 7" FROSTED GLOBE
(100W INC MAX/LED25W)



PR8 8" PRISMATIC
PR8F 8" PRISMATIC FROSTED
(200W INC MAX/LED45W)



OC 8" OPAL TAPERED GLOBE
(60W INC MAX/LED25W)