



BASELITE – BULKHEADS – LED – SPECIFICATION SHEET



PROJECT NAME: _____ PROJECT TYPE: _____

MODEL #	/	/	x	/	x	/	x	/	/	x	/	x	/	x
EXAMPLE:	BLH1		41	-		-		25W		3K	-		FR9	-

*SKIP SECTION IF OPTION DOES NOT APPLY

NOTES:



A - SHADES

- BLH SERIES**
- BLH1 - 25WLED (MAX)
 - BLH2 - 25WLED (MAX)
 - BLH3 - 25WLED (MAX)
 - BLH4 - 25WLED (MAX)
 - BLHB1 - 25WLED (MAX)
 - BLHB2 - 25WLED (MAX)
 - BLHB3 - 25WLED (MAX)
 - BLHB4 - 25WLED (MAX)

B - FINISH OPTIONS

(SEE WEBSITE FOR SWATCH COLORS)
 (*SEE NOTES FOR LIMITATIONS*)
 14, 15, 16, 17, 18, 19, 19P, 20, 20P, 20PB,
 20SB, 21, 21P, 22, 22P, 23, 23P, 38, 39, 40,
 41, 41.5, 42, 43, 44, 45, 46, 48, 49, 50, 51,
 52, 53, 54, 55, 57, 58, 59, 60, 61, 62, 63, 64,
 65, 66, 70, 71, 72, 73, 74, 75, 76, 77, 78, 79,
 80, 81, 82, 83, 84, 85, 86, 87, 88, 89, 90, 91,
 92, 93, 94, 95, 96, 97, 98, 99, 100, MG.

C - MOUNTING OPTIONS

NOT AVAILABLE

D - MOUNTING ADD-ONS

NOT AVAILABLE

E - MOUNTING COLOR

NOT AVAILABLE

F - LIGHT SOURCE

(SEE PAGE 2 FOR WATTAGE LIMITATIONS)
LIGHT EMITTED DIODE (LED)
 10W, 12W, 25W

*NOTE – MAX WATTAGE IS LISTED NEXT TO THE SHADE MODEL NUMBER IN SECTION "A". ALL WATTAGES BELOW THAT ARE ALSO AVAILABLE FOR THE SAME MODEL NUMBER.

G - LED COLOR TEMP

- 27K – 2700 KELVIN
- 3K – 3000 KELVIN
- 35K – 3500 KELVIN
- 4K – 4000 KELVIN
- 5K – 5000 KELVIN

H – ELECTRICAL OPTION

LDM120
 LDM0-10V

I – ACRYLIC OPTIONS

CL9, FR9, OPAL

J – ACCESSORIES

NOT AVAILABLE

K – ACCESSORY COLOR

NOT AVAILABLE

NOTES

- FINISH OPTIONS 75,76, 77, 83, 84, 88, 93 AND 98 ARE APPLIED BY HAND. THESE FINISHES WILL VARY IN CONSISTENCY.
- FINISH OPTIONS 38, 39, 40, 49, 54, 57, 58, 61, 62, 63, 70, 71, 72, 73, 78, 83, 84, 88, 92, 93, 98 ONLY AVAILABLE INSIDE AND OUT OF FIXTURE. OTHER FINISHES ARE WHITE INSIDE.
- FINISH OPTIONS FOR SHADES ≤ 10" IN DIAMETER ARE THE SAME INSIDE AND OUT OF FIXTURE. SHADES > 10" IN DIAMETER ARE WHITE ON THE INSIDE.
- FINISH OPTIONS 61, 62, 70, 71, 72, 73 ARE FINISHED WITH A SUPERCHROME ON THE INSIDE FOR ALL LED LIGHT SOURCE OPTIONS.
- COLOR CORDS ARE NOT APPLICABLE FOR LED OPTIONS.
 *ALL ARMS COME WITH A CAST BACKPLATE (CB1/2", CB3/4", LWTM, CFWTM, ECT.).
 *ACCORDING TO THE LIGHT SOURCE THE BACKPLATE MAY VARY IN SIZE. (EXAMPLE: LED LIGHT SOURCE WILL HAVE A DEEPER BACKPLATE TO HOUSE THE DRIVER.).
 *ALL FIXTURES MOUNT TO A 4-O JUNCTION BOX.
 *FIXTURE DIMENSIONS MAY VARY ± 0.25.
 *RATED FOR WET LOCATION.

*D = DIAMETER

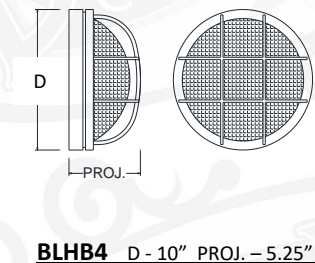
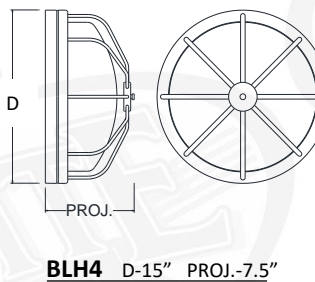
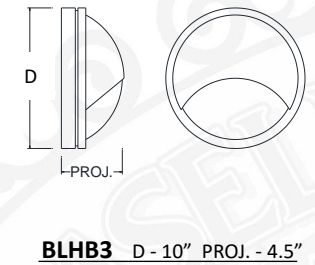
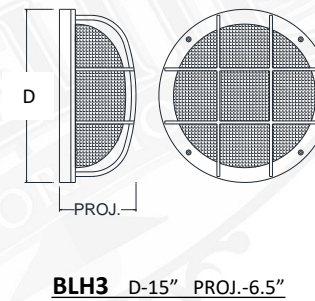
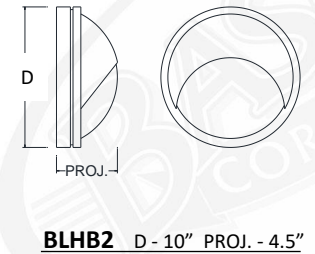
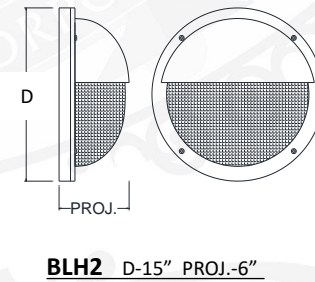
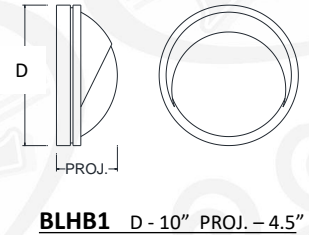
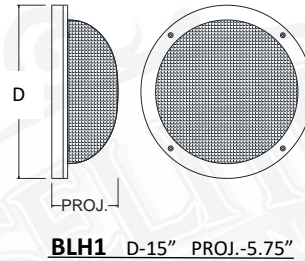



F – LIGHT SOURCE

BASELITE’S PUBLISHED LUMINAIRE PHOTOMETRIC TESTING WAS PERFORMED IN A 3-METER INTEGRATING SPHERE USING THE 4TT GEOMETRY METHOD. DATA IS CONSIDERED TO BE REPRESENTATIVE OF THE CONFIGURATIONS SHOWN, WITHIN THE TOLERANCES ALLOWED BY LIGHTING FACTS. TO OBTAIN AN IES FILE SPECIFIC TO YOUR PROJECT, PLEASE CONTACT THE FACTORY.

LIGHT EMITTING DIODE (LED)

LED 25W (MAX)- BLH1, BLH2, BLH3, BLH4, BLHB1, BLHB2, BLHB3, BLHB4

***IMPORTANT** – FOR LIGHT EMITTED DIODE (LED) LIGHT SOURCE OPTION, FIXTURES ARE LIMITED DUE TO SIZE OF THE FIXTURE AND THE CORD WATTAGE RESTRICTIONS. PLEASE SEE MAX WATTAGE AVAILABILITY. **EXAMPLE: /LED25W /**

OPTION	WATTAGE	LUMENS	CRI	VOLTAGE	DIMMING
LED10W	10W	1280	>90	120-277 VAC	TRI-ELV *120V ONLY
LED12W	12W	1481	>90	120-277 VAC	See section "H"
LED25W	25W	2812	>90	120-277 VAC	See section "H"

@3500K

H – ELECTRICAL OPTION

LED DIMMING OPTIONS

(LED10WF – ONLY AVAILABLE WITH **LDM120** - TRI-ELV DIMMING OPITON) ALL OTHER WATTAGES CAN CHOOSE FROM THE OPTIONS BELOW. CONTACT DRIVER MANUFACTURER FOR FURTHER SPECIFICATIONS.

LDM120 - TRIAC / ELV – INPUT 120 / 277V - DIMMING AT 120 VOLT ONLY

LDM0-10V – 0 – 10V – DIMMING AT 120 / 277 VOLTS

I – ACRYLIC OPTIONS



EX: BLH3.**CL9**.44.100INC

CL9 9” CLEAR PRISMATIC LENSE



EX: BLH1.**FR9**.41.100INC

FR9 9” FROSTED LENSE



EX: BLH4.**OPAL**.53.100INC

OPAL OPAL LENSE