



# BASELITE – WAREHOUSE SHADE – LED – SPEC SHEET



PROJECT NAME: \_\_\_\_\_ PROJECT TYPE: \_\_\_\_\_

MODEL #	/	/	/	/	/	/	/	/	/	/	/
	A	B	C	D	E	F	G	H	I	J	K
EXAMPLE:	W512	41	E16	SQ 1/2"	43	45W	3K	LDM120	PR3	GR12	44

\*SKIP SECTION IF OPTION DOES NOT APPLY

NOTES:



W512/23P/GR12/BLC/100INC

## A - SHADES

### WAREHOUSE

- W508 - 12WLED (MAX)
- W512 - 25WLED (MAX)
- W514 - 35WLED (MAX)
- WC514 - 35WLED (MAX)
- W516 - 50WLED (MAX)
- W516X - 50WLED (MAX)
- W5167 - 50WLED (MAX)
- W518 - 80WLED (MAX)
- W520 - 80WLED (MAX)
- W5206 - 80WLED (MAX)
- W524 - 100WLED (MAX)
- W527 - 100WLED (MAX)

## B - FINISH OPTIONS

(SEE WEBSITE FOR SWATCH COLORS)  
(\*SEE NOTES FOR LIMITATIONS\*)

- 14, 15, 16, 17, 18, 19, 19P, 20, 20P, 20PB, 20SB, 21, 21P, 22, 22P, 23, 23P, 38, 39, 40, 41, 41.5, 42, 43, 44, 45, 46, 48, 49, 50, 51, 52, 53, 54, 55, 57, 58, 59, 60, 61, 62, 63, 64, 65, 66, 70, 71, 72, 73, 74, 75, 76, 77, 78, 79, 80, 81, 82, 83, 84, 85, 86, 87, 88, 89, 90, 91, 92, 93, 94, 95, 96, 97, 98, 99, 100

## C - MOUNTING OPTIONS

### 1/2" ARM EXTENSIONS

- E1, E2, E3, E4, B1, E16, E17, E18, E26, E27

### 3/4" ARM EXTENSIONS

- E3A, E4A, E5, E6, E7, E8, E9, E10, E11, E12, E13, B15, B15S, E19, E20, E21, E25

### E14 - CREATE YOUR OWN

(BASELITE WILL TAKE YOUR SKETCH AND FABRICATE A CUSTOM ARM EXTENSION TO MEET YOUR NEEDS).

### 1/2" WALL MOUNT

- B13, WM13R, WM13X, B10, B11, B101

### 3/4" WALL MOUNT

- B9, B9C, B12, WM10, WM11, WM14X, WM15, WM35X, WM55X, WM60X, WM61X WM70X, WM71X

### LED CORD MOUNT

- LBLC, LWHC, LTCB, LTCW, LTCHB, LTCHW, LTLB, LTLW, LTLB, LTLW, LRCB, LRCW, LRCHB, LRCHW, LFHB, LFHW, LHBL, LHWHC, LCBLC, LCWHC, LCHB, LCHW

### STEM MOUNT

- ST6, ST12, ST18, ST24, ST36, ST48, STXX

## D - MOUNTING ADD-ONS

### LED ADD-ONS

LWTM, LSLC, LSTC

### UNIVERSAL ADD-ONS

SQ 1/2", SQ 3/4", FH 1/2", FH 3/4", TRB 1/2", TRB 3/4", SWL, LGSWL, CNK, INB, RINB

## E - MOUNTING COLOR

SEE SECTION "B" FOR COLOR OPTIONS.

## F - LIGHT SOURCE

(SEE PAGE 4 FOR WATTAGE LIMITATIONS)

### LIGHT EMITTED DIODE (LED)

LED10WF, LED12W, LED25W, LED35W, LED50W, LED80W, LED100W

\*NOTE - MAX WATTAGE IS LISTED NEXT TO THE SHADE MODEL NUMBER IN SECTION "A". ALL WATTAGES BELOW THAT ARE ALSO AVAILABLE FOR THE SAME MODEL NUMBER.

## G - LED COLOR TEMP

- 27K - 2700 KELVIN
- 3K - 3000 KELVIN
- 35K - 3500 KELVIN
- 4K - 4000 KELVIN
- 5K - 5000 KELVIN

## H - ELECTRICAL OPTION

(SEE PAGE 4 FOR DIMMING OPTION SPECIFICATIONS)

- LDM120
- LDM0-10

## I - GLASS OPTIONS

CL3, CL4, CLT3, CLT4, BL3, BL4, RE3, RE4, GR3, GR4, AH3, AH4, FR3, FR4, FRT3, FRT4, PR3, PR4, BA, BAX, BAF, PR8, PR8F, FN, OC

## J - ACCESSORIES

GR8, GR12, GR14, GR16, GR18, GR20, GR24, GR27, REF, UGR, LGR8, LGR12, LGR14, LGR16, LGR18, LGR20, LGR24, LGR27, CRL8, CRL12, CRL14, CRL16, CRL18, CRL20, FLE12, FLE14, FLE16, FLE18, FLE20, FLE24, FLE27, FGR8, FGR12, FGR14, FGR16, FGR18, FGR20, FGR24, FGR27, GU-1, GU-2, WG-1, WG-2

## K - ACCESSORY COLOR

SEE SECTION "B" FOR COLOR OPTIONS.

## NOTES

- (1). FINISH OPTIONS 75,76, 77, 83, 84, 88, 93 AND 98 ARE APPLIED BY HAND. THESE FINISHES WILL VARY IN CONSISTENCY.
  - (2). FINISH OPTIONS 38, 39, 40, 49, 54, 57, 58, 61, 62, 63, 70, 71, 72, 73, 78, 83, 84, 88, 92, 93, 98 ONLY AVAILABLE INSIDE AND OUT OF FIXTURE. OTHER FINISHES ARE WHITE INSIDE.
  - (3). FINISH OPTIONS FOR SHADES ≤ 10" IN DIAMETER ARE THE SAME INSIDE AND OUT OF FIXTURE. SHADES > 10" IN DIAMETER ARE WHITE ON THE INSIDE.
  - (4). FINISH OPTIONS 61, 62, 70, 71, 72, 73 ARE FINISHED WITH A SUPERCHROME ON THE INSIDE FOR ALL LED LIGHT SOURCE OPTIONS.
  - (5). COLOR CORDS ARE NOT APPLICABLE FOR LED OPTIONS.
- \*ALL ARMS COME WITH A CAST BACKPLATE (CB1/2", CB3/4", LWTM, CFWTM, ECT.).
- \*ACCORDING TO THE LIGHT SOURCE THE BACKPLATE MAY VARY IN SIZE. (EXAMPLE: LED LIGHT SOURCE WILL HAVE A DEEPER BACKPLATE TO HOUSE THE DRIVER.).
- \*ALL FIXTURES MOUNT TO A 4-0 JUNCTION BOX.
- \*FIXTURE DIMENSIONS MAY VARY ± 0.25.
- \*CORD AND CANOPY COME IN THE SAME COLOR.

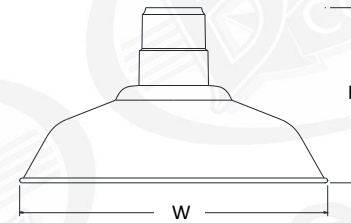

- W508 H-6" W-8"
- W512 H-8" W-12"
- W514 H-9" W-14"
- W516 H-9" W-16"
- W518 H-9" W-18"
- W520 H-10" W-20"

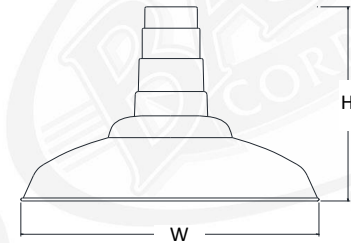

- W524 H-16" W-24"
- W527 H-16" W-27"

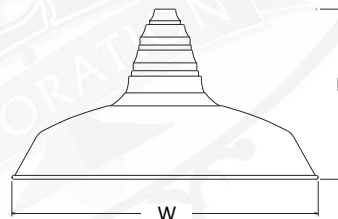

- W5206 H-11" W-20"

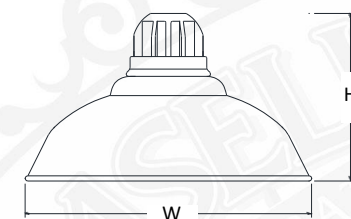

- WC514 H-8" W-14"



- W516X H-10.5" W-16.5"

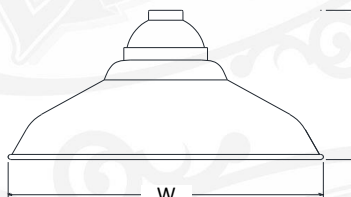

- W5167 H-7.5" W-16"



**C - MOUNTING OPTIONS**

**1/2" ARM EXTENSIONS**

\*ARMS RATED FOR WET LOCATION \* MAXIMUM SECTIONS OF ARMS ARE DIMENSIONED

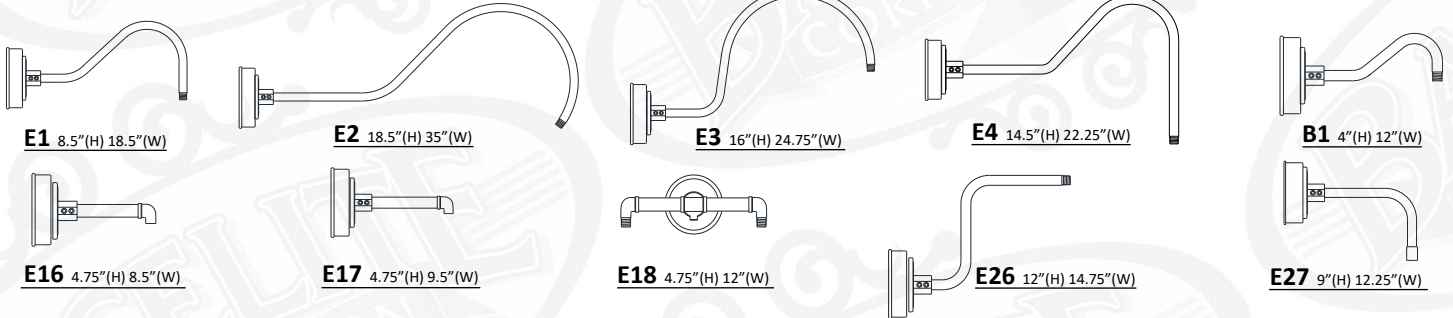

**E1** 8.5"(H) 18.5"(W)

**E2** 18.5"(H) 35"(W)

**E3** 16"(H) 24.75"(W)

**E4** 14.5"(H) 22.25"(W)

**B1** 4"(H) 12"(W)

**E16** 4.75"(H) 8.5"(W)

**E17** 4.75"(H) 9.5"(W)

**E18** 4.75"(H) 12"(W)

**E26** 12"(H) 14.75"(W)

**E27** 9"(H) 12.25"(W)

**3/4" ARM EXTENSIONS**

\*ARMS RATED FOR WET LOCATION \* MAXIMUM SECTIONS OF ARMS ARE DIMENSIONED

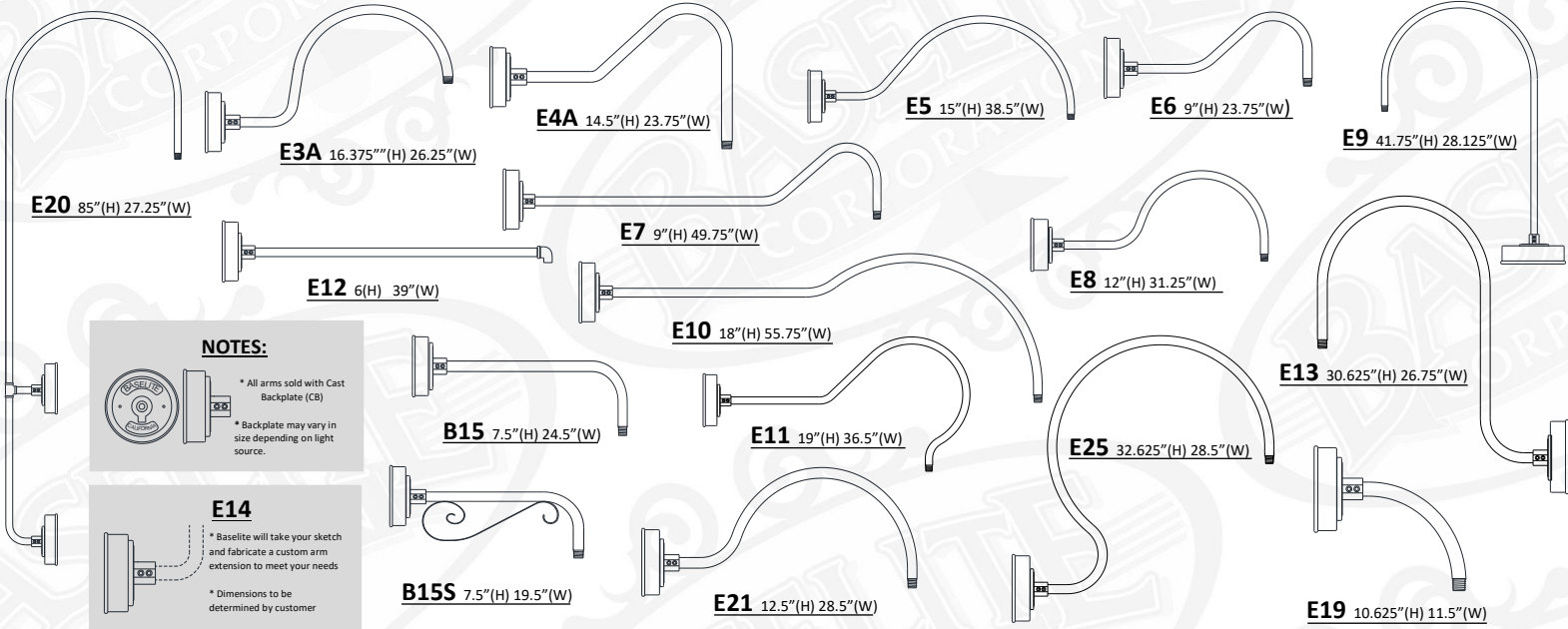

**E20** 85"(H) 27.25"(W)

**E3A** 16.375"(H) 26.25"(W)

**E4A** 14.5"(H) 23.75"(W)

**E5** 15"(H) 38.5"(W)

**E6** 9"(H) 23.75"(W)

**E9** 41.75"(H) 28.125"(W)

**NOTES:**



\* All arms sold with Cast Backplate (CB)  
\* Backplate may vary in size depending on light source.

**E14**

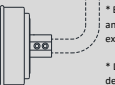

\* Baselite will take your sketch and fabricate a custom arm extension to meet your needs  
\* Dimensions to be determined by customer

**E12** 6(H) 39"(W)

**E7** 9"(H) 49.75"(W)

**E8** 12"(H) 31.25"(W)

**E10** 18"(H) 55.75"(W)

**B15** 7.5"(H) 24.5"(W)

**E11** 19"(H) 36.5"(W)

**E25** 32.625"(H) 28.5"(W)

**E13** 30.625"(H) 26.75"(W)

**B15S** 7.5"(H) 19.5"(W)

**E21** 12.5"(H) 28.5"(W)

**E19** 10.625"(H) 11.5"(W)

**1/2" WALL MOUNTS**

\*MOUNTS RATED FOR WET LOCATION \* MAXIMUM SECTIONS OF MOUNTS ARE DIMENSIONED

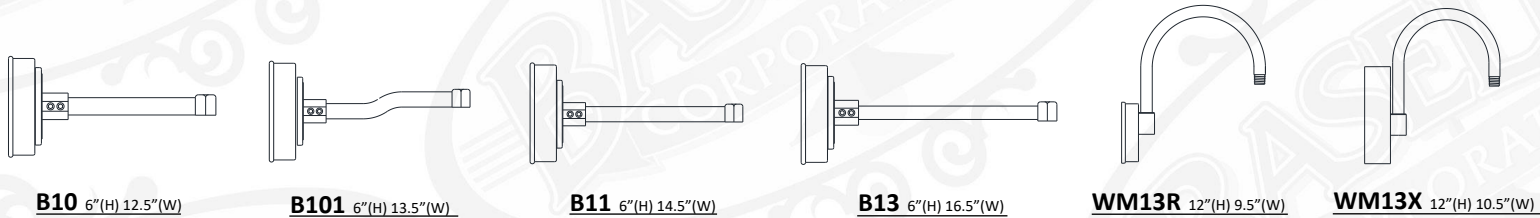

**B10** 6"(H) 12.5"(W)

**B101** 6"(H) 13.5"(W)

**B11** 6"(H) 14.5"(W)

**B13** 6"(H) 16.5"(W)

**WM13R** 12"(H) 9.5"(W)

**WM13X** 12"(H) 10.5"(W)

**3/4" WALL MOUNTS**

\*MOUNTS RATED FOR WET LOCATION \* MAXIMUM SECTIONS OF MOUNTS ARE DIMENSIONED

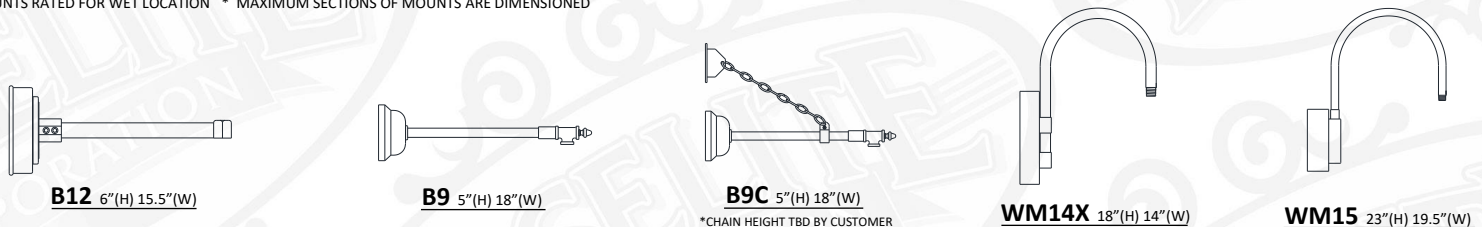

**B12** 6"(H) 15.5"(W)

**B9** 5"(H) 18"(W)

**B9C** 5"(H) 18"(W)

\*CHAIN HEIGHT TBD BY CUSTOMER

**WM14X** 18"(H) 14"(W)

**WM15** 23"(H) 19.5"(W)



**C - MOUNTING OPTIONS (CONTINUED)**

**3/4" WALL MOUNTS**

\*MOUNTS RATED FOR WET LOCATION \* MAXIMUM SECTIONS OF MOUNTS ARE DIMENSIONED



**WM35X** 26"(H) 22"(W)



**WM55X** 19"(H) 27"(W)

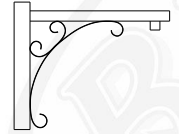

**WM60X** 18"(H) 22"(W)

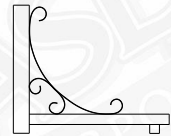

**WM61X** 18"(H) 22"(W)

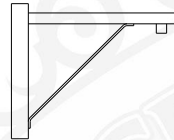

**WM70X** 18"(H) 22"(W)

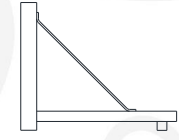

**WM71X** 18"(H) 22"(W)

**STEM MOUNTS**

\*STEMS RATED FOR DAMP LOCATION

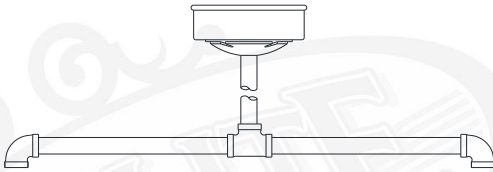

**DP24** DOUBLE PENDANT 20"(H) 24"(W)

\*DP24 COMES STANDARD WITH LSTC AND ST18



**ST(XX)** STEM- 1/2" NPT

XX = LENGTH OF STEM  
(EXAMPLE - "ST18" = STEM MOUNT 18" LENGTH)  
\*CANOPY NOT INCLUDED, ADD IN SECTION D  
\* 1/4" NPT AND 3/4" NPT AVAILABLE UPON REQUEST



**SC24** SCROLL STEM 33"(H) 26"(W)

\*SC24 COMES STANDARD WITH LSTC

**LED CORD MOUNTS**

\*FOR LED & COMPACT FLUORESCENT OPTIONS, CANOPIES WILL VARY IN SIZE DUE TO SIZE OF THE DRIVER/BALLAST THAT WILL BE LOCATED INSIDE OF THE CANOPY. \*CORDS RATED FOR DRY LOCATION  
\*CANOPY DIMENSIONS: 4" (H) 5.5" (W) \*CORD AND CANOPY COME IN THE SAME COLOR.



**LBLC** 8' BLACK CORD

**LWHC** 8' WHITE CORD



**LTCB** 8' BLACK CORD, CABLE, and LOOP

**LTCW** 8' WHITE CORD, CABLE, and LOOP



**LTCHB** 8' BLACK CORD, 3' CHAIN, and LOOP

**LTCHW** 8' WHITE CORD, 3' CHAIN, and LOOP



**LTLB** 8' BLACK TELEPHONE CORD AND CABLE

**LTLW** 8' WHITE TELEPHONE CORD AND CABLE

\* Not available with compact fluorescent



**LRCB** 8' BLACK CORD, CABLE, and LOOP

**LRCW** 8' WHITE CORD, CABLE, and LOOP



**LRCHB** 8' BLACK CORD, 3' CHAIN, and LOOP

**LRCHW** 8' WHITE CORD, 3' CHAIN, and LOOP



**LFBH** 8' BLACK CORD WITH FLAT HUB

**LFHW** 8' WHITE CORD WITH FLAT HUB



**LCBLC** 8' BLACK CORD and CABLE

**LCWHC** 8' WHITE CORD and CABLE



**LCHB** 8' BLACK CORD, 3' CHAIN, and LOOP

**LCHW** 8' WHITE CORD, 3' CHAIN, and LOOP  
\* Loop may vary due to shade style

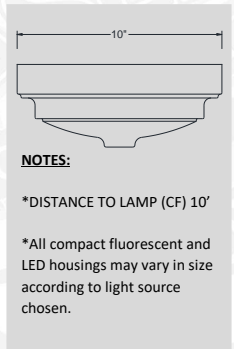

**NOTES:**

\*DISTANCE TO LAMP (CF) 10"

\*All compact fluorescent and LED housings may vary in size according to light source chosen.



**D - MOUNTING ADD-ONS**

**LED - STEM AND ARM ADD-ONS**

\* FOR LED & COMPACT FLUORESCENT OPTIONS, CANOPIES WILL VARY IN SIZE DUE TO SIZE OF THE DRIVER/BALLAST THAT WILL BE LOCATED INSIDE OF THE CANOPY.

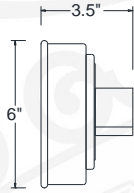

**LWTM** WEATHERTIGHT LED WALL MOUNT

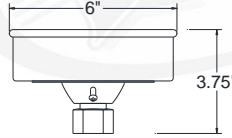

**LSLC** LED SLOPE CEILING CANOPY

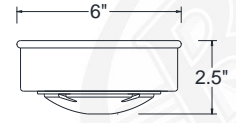

**LSTC** LED STEM MOUNT CANOPY

**UNIVERSAL STEM AND ARM ADD-ONS**

\* EXAMPLE FOR MULTIPLE MOUNTING ADD-ONS:

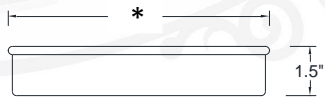
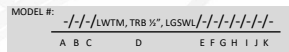

**CNK** CANOPY For MULTIPLE FIXTURES  
\*CNK dimensions vary on number of fixtures applied

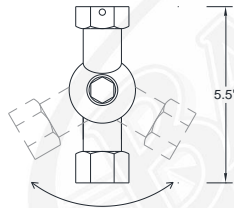

**LGSWL** 1/2" NPT SWIVEL  
For all shades greater than 7" wide in diameter

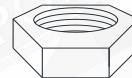

**FH 1/2"** FLAT HUB 1/2"  
**FH 3/4"** FLAT HUB 3/4"

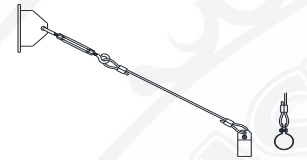

**TRB 1/2"-4' Cable** SUPPORT  
**TRB 3/4"-4' Cable** SUPPORT

**F – LIGHT SOURCE**

BASELITE'S PUBLISHED LUMINAIRE PHOTOMETRIC TESTING WAS PERFORMED IN A 3-METER INTEGRATING SPHERE USING THE 4TT GEOMETRY METHOD. DATA IS CONSIDERED TO BE REPRESENTATIVE OF THE CONFIGURATIONS SHOWN, WITHIN THE TOLERANCES ALLOWED BY LIGHTING FACTS. TO OBTAIN AN IES FILE SPECIFIC TO YOUR PROJECT, PLEASE CONTACT THE FACTORY.

LIGHT EMITTING DIODE (LED)						
LED 12W (MAX) – W508						<p><b>*IMPORTANT – FOR LIGHT EMITTED DIODE (LED) LIGHT SOURCE OPTION, FIXTURES ARE LIMITED DUE TO SIZE OF THE FIXTURE AND THE CORD WATTAGE RESTRICTIONS. PLEASE SEE MAX WATTAGE AVAILABILITY. EXAMPLE: /LED80W/</b></p>
LED 25W (MAX) – W512						
LED 35W (MAX) – W514, WC514						
LED 50W (MAX) – W516, W516X, W5167						
LED 80W (MAX) - W518, W520, W5206						
LED 100W (MAX) - W524, W527						
OPTION	WATTAGE	LUMENS	CRI	VOLTAGE	DIMMING	
LED10WF	10W	1280	>90	120-277 VAC	TRI-ELV *120V ONLY	
LED12W	12W	1481	>90	120-277 VAC	See section "H"	
LED25W	25W	2812	>90	120-277 VAC	See section "H"	
LED35W	35W	3743	>90	120-277 VAC	See section "H"	
LED50W	50W	5750	>90	120-277 VAC	See section "H"	
LED80W	80W	8800	>90	120-277 VAC	See section "H"	
LED100W	100W	10500	>90	120-277 VAC	See section "H"	
		@3500K				

**H – ELECTRICAL OPTION**

**LED DIMMING OPTIONS**

LED10WF – ONLY AVAILABLE WITH **LDM120** - TRI-ELV DIMMING OPITON. ALL OTHER WATTAGES CAN CHOOSE FROM THE OPTIONS BELOW. CONTACT DRIVER MANUFACTURER FOR FURTHER SPECIFICATIONS.

**LDM120** - TRIAC / ELV – INPUT 120 / 277V - DIMMING AT 120 VOLT ONLY

**LDM0-10V** – 0 – 10V – DIMMING AT 120 / 277 VOLTS



**I – GLASS OPTIONS**

\*NOTE: MUST USE TEMPERED GLASS FOR LIGHT FIXTURES USING HIGH INTENSITY DISCHARGE (HID) LIGHT SOURCE OPTION.



**CL3** 3" CLEAR GLASS



**PR3** 3" PRISMATIC GLASS



**RE3** 3" RED GLASS



**BL3** 3" BLUE GLASS

**CL4** 4" CLEAR GLASS

**PR4** 4" PRISMATIC GLASS

**RE4** 4" RED GLASS

**BL4** 4" BLUE GLASS

**CLT3** 3" CLEAR TEMPERED

**CLT4** 4" CLEAR TEMPERED



**FR3** 3" FROSTED GLASS



**AH3** 3" AMBER HYDE GLASS



**GR3** 3" GREEN GLASS

**FR4** 4" FROSTED GLASS

**AH4** 4" AMBER HYDE GLASS

**GR4** 4" GREEN GLASS

**FRT3** 3" FROSTED TEMPERED

**FRT4** 4" FROSTED TEMPERED

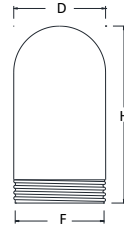

GLASS – DIMENSIONS	
3" GLASS	
Diameter	3.34"
Height	6.93"
Fitter	3.29"
4" GLASS	
Diameter	4.34"
Height	8.37"
Fitter	4.29"

GLASS – MAX WATTAGE	
3" GLASS	– 100W INC / LED12W
4" GLASS	– 200W INC / LED25W



**BA** 6" OPAL BALL  
(100W INC MAX/LED12W)



**BAX** 9" CLEAR GLOBE  
**BAF** 9" FROSTED GLOBE  
(200W INC MAX/LED25W)



**FN** 8" CLEAR TEXTURED GLOBE  
(150W INC MAX/LED25W)



**BA7** 7" CLEAR GLOBE



**PR8** 8" PRISMATIC



**OC** 8" OPAL TAPERED GLOBE  
(60W INC MAX/LED25W)

**BA7F** 7" FROSTED GLOBE  
(100W INC MAX/LED25W)

**PR8F** 8" PRISMATIC FROSTED  
(200W INC MAX/LED45W)

**J – ACCESSORIES**

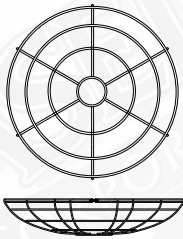

**GR8** 8" WIRE GRILL

**GR12** 12" WIRE GRILL

**GR14** 14" WIRE GRILL

**GR16** 16" WIRE GRILL

**GR18** 18" WIRE GRILL

**GR20** 20" WIRE GRILL

**GR24** 24" WIRE GRILL

**GR27** 27" WIRE GRILL

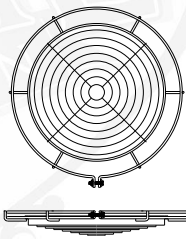

**LGR8** 8" LOUVERED GRILL

**LGR12** 12" LOUVERED GRILL

**LGR14** 14" LOUVERED GRILL

**LGR16** 16" LOUVERED GRILL

**LGR18** 18" LOUVERED GRILL

**LGR20** 20" LOUVERED GRILL

**LGR24** 24" LOUVERED GRILL

**LGR27** 27" LOUVERED GRILL

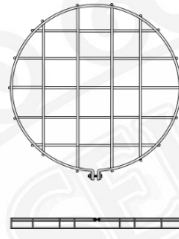

**FGR8** 8" FLAT GRILL

**FGR12** 12" FLAT GRILL

**FGR14** 14" FLAT GRILL

**FGR16** 16" FLAT GRILL

**FGR18** 18" FLAT GRILL

**FGR20** 20" FLAT GRILL

**FGR24** 24" FLAT GRILL

**FGR27** 27" FLAT GRILL

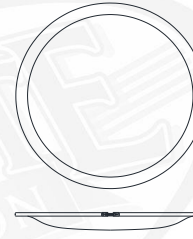

**CRL8** 8" CURVED POLYCARB LENS

**CRL12** 12" CURVED POLYCARB LENS

**CRL14** 14" CURVED POLYCARB LENS

**CRL16** 16" CURVED POLYCARB LENS

**CRL18** 18" CURVED POLYCARB LENS

**CRL20** 20" CURVED POLYCARB LENS

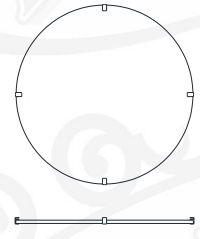

**FLE8** 8" FLAT CLEAR LENS

**FLE12** 12" FLAT CLEAR LENS

**FLE14** 14" FLAT CLEAR LENS

**FLE16** 16" FLAT CLEAR LENS

**FLE18** 18" FLAT CLEAR LENS

**FLE20** 20" FLAT CLEAR LENS

**FLE24** 24" FLAT CLEAR LENS

**FLE27** 27" FLAT CLEAR LENS

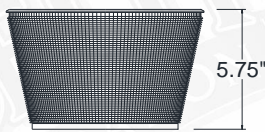

**REF** 9.5" DIAMETER REFRACTOR



**UGR** U- WIRE GUARD

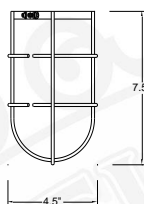

**WG-1** WIRE GUARD

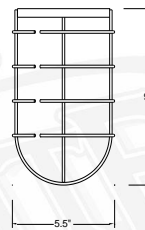

**WG-2** WIRE GUARD  
Available for shades  
12" or higher

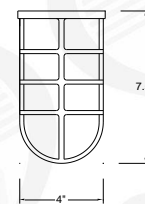

**GU-1** CAST ALUMINUM GUARD

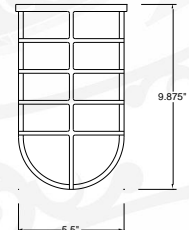

**GU-2** CAST ALUMINUM GUARD  
Available for shades 12" or higher