



BASELITE – UPLIGHT SHADE – LED – SPEC SHEET



PROJECT NAME: _____ PROJECT TYPE: _____

MODEL #	/	/	/	/	/	/	/	/	/	/	/
EXAMPLE:	A UL414	B 41	C E16	D SQ ½"	E 43	F 45W	G 3K	H LDM120	I PR3	J GR12	K 44

*SKIP SECTION IF OPTION DOES NOT APPLY

NOTES:



A - SHADES

UPLIGHT SHADES

- UL414 - 25WLED (MAX)
- UL416 - 25WLED (MAX)
- UL418 - 25WLED (MAX)
- UL422 - 25WLED (MAX)

B - FINISH OPTIONS

(SEE WEBSITE FOR SWATCH COLORS)
(*SEE NOTES FOR LIMITATIONS*)
14, 15, 16, 17, 18, 19, 19P, 20, 20P, 20PB, 20SB, 21, 21P, 22, 22P, 23, 23P, 38, 39, 40, 41, 41.5, 42, 43, 44, 45, 46, 48, 49, 50, 51, 52, 53, 54, 55, 57, 58, 59, 60, 61, 62, 63, 64, 65, 66, 70, 71, 72, 73, 74, 75, 76, 77, 78, 79, 80, 81, 82, 83, 84, 85, 86, 87, 88, 89, 90, 91, 92, 93, 94, 95, 96, 97, 98, 99, 100, MG.

C – MOUNTING OPTIONS

- ½" ARM EXTENSIONS**
E1, E2, E3, E4, B1, E16, E17, E18, E26, E27
- ¾" ARM EXTENSIONS**
E3A, E4A, E5, E6, E7, E8, E9, E10, E11, E12, E13, B15, B15S, E19, E20, E21, E25
- E14 - CREATE YOUR OWN**
(BASELITE WILL TAKE YOUR SKETCH AND FABRICATE A CUSTOM ARM EXTENSION TO MEET YOUR NEEDS).
- ½" WALL MOUNT**
B13, WM13R, WM13X, B10, B11, B101
- ¾" WALL MOUNT**
B9, B9C, B12, WM10, WM11, WM14X, WM15, WM35X, WM55X, WM60X, WM61X WM70X, WM71X
- LED CORD MOUNT**
LBLC, LWHC, LTCB, LTCW, LTCHB, LTCHW, LTLB, LTLW, LTLB, LTLW, LRCB, LRCW, LRCHB, LRCHW, LFHB, LFHW, LHBLC, LHWHC, LCBLC, LCWHC, LCHB, LCHW
- STEM MOUNT**
ST6, ST12, ST18, ST24, ST36, ST48, STXX

D – MOUNTING ADD-ONS

- LED ADD-ONS**
LWTM, LSLC, LSTC
- UNIVERSAL ADD-ONS**
SQ ½", SQ ¾", FH ½", FH ¾", TRB ½", TRB ¾", SWL, LGSWL, CNK, INB, RINB

E – MOUNTING COLOR

SEE SECTION "B" FOR COLOR OPTIONS.

F – LIGHT SOURCE

(SEE PAGE 4 FOR WATTAGE LIMITATIONS)
LIGHT EMITTED DIODE (LED)
LED10WF, LED12W, LED25W

*NOTE – MAX WATTAGE IS LISTED NEXT TO THE SHADE MODEL NUMBER IN SECTION "A". ALL WATTAGES BELOW THAT ARE ALSO AVAILABLE FOR THE SAME MODEL NUMBER.

G – LED COLOR TEMP

- 27K – 2700 KELVIN
- 3K – 3000 KELVIN
- 35K – 3500 KELVIN
- 4K – 4000 KELVIN
- 5K – 5000 KELVIN

H – ELECTRICAL OPTION

(SEE PAGE 4 FOR DIMMING OPTION SPECIFICATIONS)
LDM120
LDM0-10

I – GLASS OPTIONS

- CL3, CL4, CLT3, CLT4, BL3, BL4, RE3, RE4, GR3, GR4, AH3, AH4, FR3, FR4, FRT3, FRT4, PR3, PR4, BA, BAX, BAF, PR8, PR8F, FN, OC

J – ACCESSORIES

- GR14, GR16, GR18, GR22, REF, UGR, LGR14, LGR16, LGR18, LGR22, CRL14, CRL16, CRL18, CRL22, FLE14, FLE16, FLE18, FLE22, FGR14, FGR16, FGR18, FGR22, GU-1, GU-2, WG-1, WG-2

K – ACCESSORY COLOR

SEE SECTION "B" FOR COLOR OPTIONS.

NOTES

- (1). FINISH OPTIONS 75,76, 77, 83, 84, 88, 93 AND 98 ARE APPLIED BY HAND. THESE FINISHES WILL VARY IN CONSISTENCY.
- (2). FINISH OPTIONS 38, 39, 40, 49, 54, 57, 58, 61, 62, 63, 70, 71, 72, 73, 78, 83, 84, 88, 92, 93, 98 ONLY AVAILABLE INSIDE AND OUT OF FIXTURE. OTHER FINISHES ARE WHITE INSIDE.
- (3). FINISH OPTIONS FOR SHADES ≤ 10" IN DIAMETER ARE THE SAME INSIDE AND OUT OF FIXTURE. SHADES > 10" IN DIAMETER ARE WHITE ON THE INSIDE.
- (4). FINISH OPTIONS 61, 62, 70, 71, 72, 73 ARE FINISHED WITH A SUPERCHROME ON THE INSIDE FOR ALL LED LIGHT SOURCE OPTIONS.
- (5). COLOR CORDS ARE NOT APPLICABLE FOR LED OPTIONS.
*ALL ARMS COME WITH A CAST BACKPLATE (CB1/2", CB3/4", LWTM, CFWTM, ECT.).
*ACCORDING TO THE LIGHT SOURCE THE BACKPLATE MAY VARY IN SIZE. (EXAMPLE: LED LIGHT SOURCE WILL HAVE A DEEPER BACKPLATE TO HOUSE THE DRIVER).
*ALL FIXTURES MOUNT TO A 4-0 JUNCTION BOX.
*FIXTURE DIMENSIONS MAY VARY ± 0.25.
*CORD AND CANOPY COME IN THE SAME COLOR.

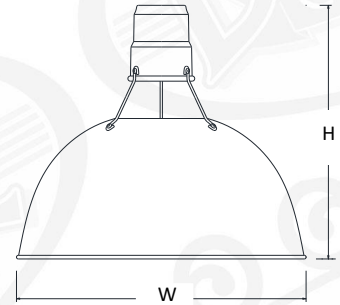

UL414	H-10"	W-14"
UL416	H-14"	W-16"
UL418	H-16"	W-18"
UL422	H-20"	W-22"



C - MOUNTING OPTIONS

1/2" ARM EXTENSIONS

*ARMS RATED FOR WET LOCATION * MAXIMUM SECTIONS OF ARMS ARE DIMENSIONED

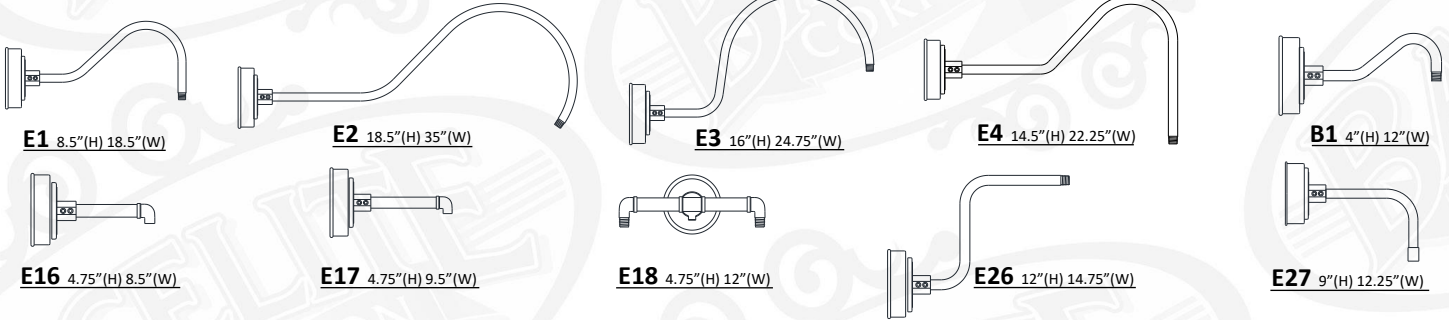

3/4" ARM EXTENSIONS

*ARMS RATED FOR WET LOCATION * MAXIMUM SECTIONS OF ARMS ARE DIMENSIONED

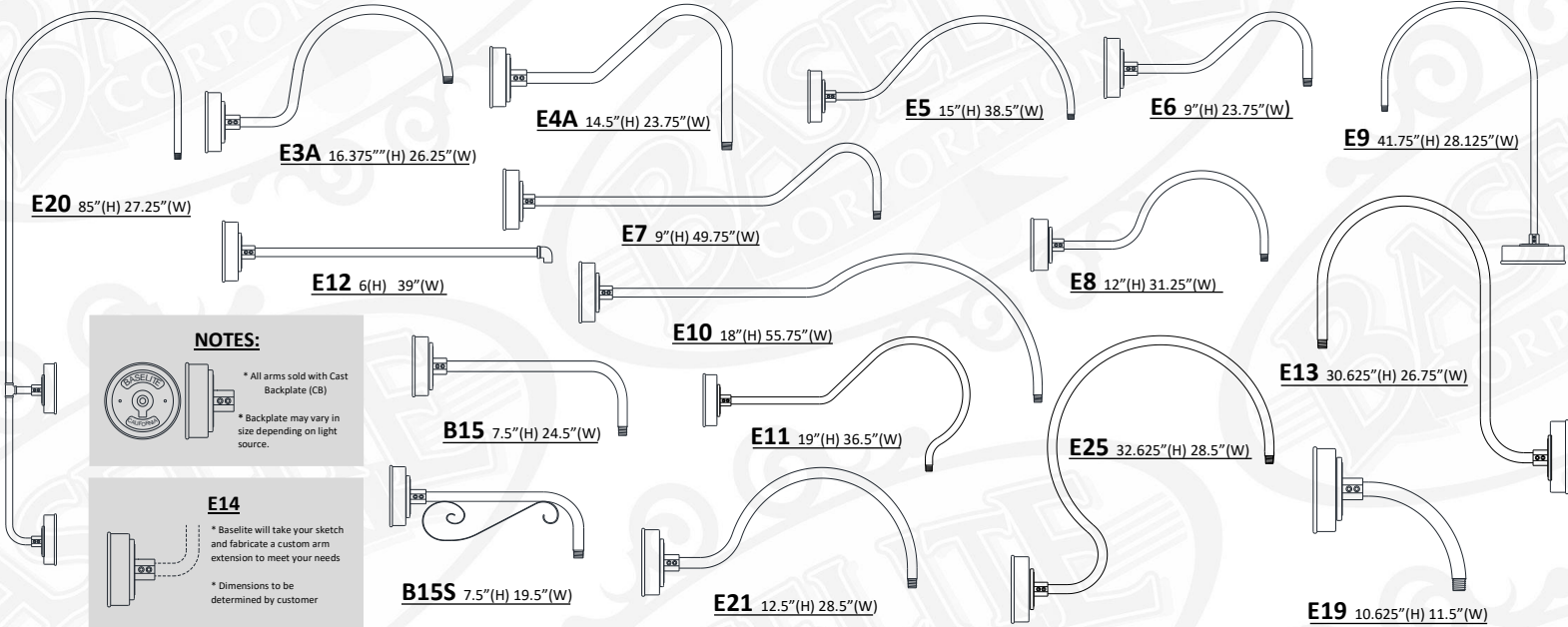

1/2" WALL MOUNTS

*MOUNTS RATED FOR WET LOCATION * MAXIMUM SECTIONS OF MOUNTS ARE DIMENSIONED

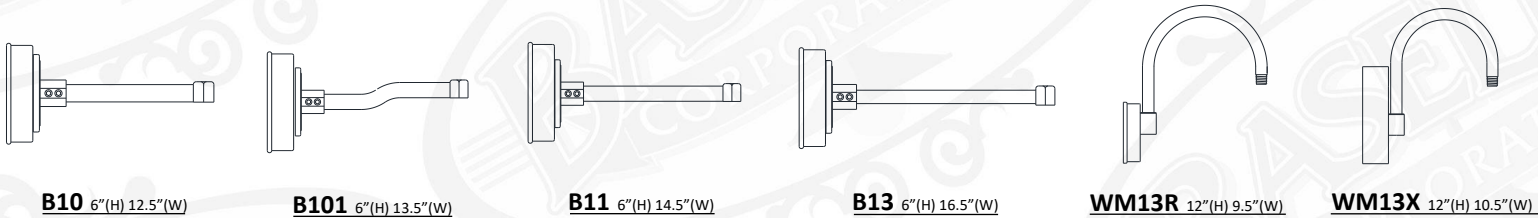

3/4" WALL MOUNTS

*MOUNTS RATED FOR WET LOCATION * MAXIMUM SECTIONS OF MOUNTS ARE DIMENSIONED

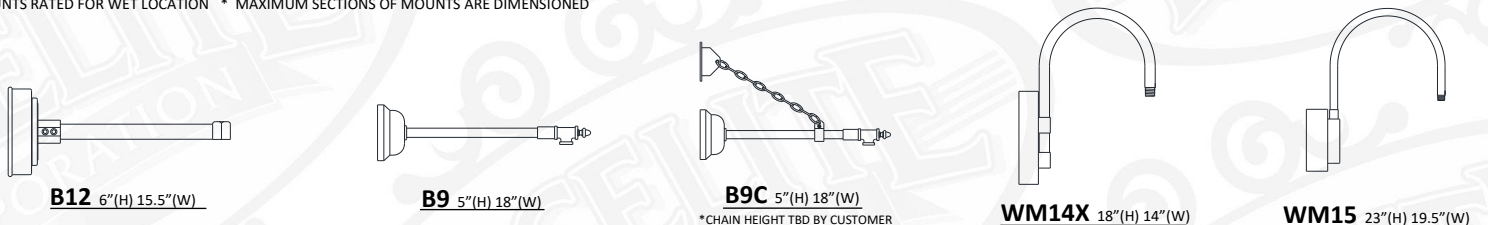



C - MOUNTING OPTIONS (CONTINUED)

3/4" WALL MOUNTS

*MOUNTS RATED FOR WET LOCATION * MAXIMUM SECTIONS OF MOUNTS ARE DIMENSIONED



WM35X 26"(H) 22"(W)



WM55X 19"(H) 27"(W)

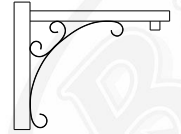

WM60X 18"(H) 22"(W)

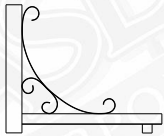

WM61X 18"(H) 22"(W)

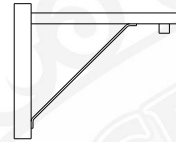

WM70X 18"(H) 22"(W)

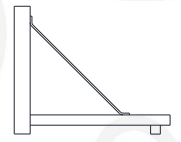

WM71X 18"(H) 22"(W)

STEM MOUNTS

*STEMS RATED FOR DAMP LOCATION

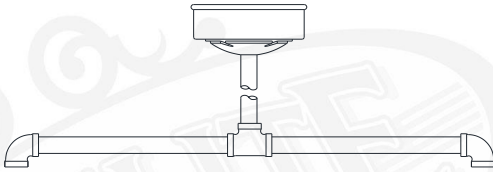

DP24 DOUBLE PENDANT 20"(H) 24"(W)

*DP24 COMES STANDARD WITH LSTC AND ST18



ST(XX) STEM- 1/2" NPT

XX = LENGTH OF STEM

(EXAMPLE - "ST18" = STEM MOUNT 18" LENGTH)

*CANOPY NOT INCLUDED, ADD IN SECTION D

* 1/4" NPT AND 3/4" NPT AVAILABLE UPON REQUEST



SC24 SCROLL STEM 33"(H) 26"(W)

*SC24 COMES STANDARD WITH LSTC

LED CORD MOUNTS

*FOR LED & COMPACT FLUORESCENT OPTIONS, CANOPIES WILL VARY IN SIZE DUE TO SIZE OF THE DRIVER/BALLAST THAT WILL BE LOCATED INSIDE OF THE CANOPY. *CORDS RATED FOR DRY LOCATION

*CANOPY DIMENSIONS: 4" (H) 5.5" (W) *CORD AND CANOPY COME IN THE SAME COLOR.



LBLC 8' BLACK CORD

LWHC 8' WHITE CORD

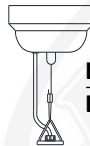

LTCB 8' BLACK CORD, CABLE, and LOOP

LTCW 8' WHITE CORD, CABLE, and LOOP



LTCHB 8' BLACK CORD, 3' CHAIN, and LOOP

LTCHW 8' WHITE CORD, 3' CHAIN, and LOOP



LTLB 8' BLACK TELEPHONE CORD AND CABLE

LTLW 8' WHITE TELEPHONE CORD AND CABLE

* Not available with compact fluorescent



LRCB 8' BLACK CORD, CABLE, and LOOP

LRCW 8' WHITE CORD, CABLE, and LOOP



LRCHB 8' BLACK CORD, 3' CHAIN, and LOOP

LRCHW 8' WHITE CORD, 3' CHAIN, and LOOP



LFBH 8' BLACK CORD WITH FLAT HUB

LFWH 8' WHITE CORD WITH FLAT HUB



LCBLC 8' BLACK CORD and CABLE

LCWHC 8' WHITE CORD and CABLE



LCHB 8' BLACK CORD, 3' CHAIN, and LOOP

LCHW 8' WHITE CORD, 3' CHAIN, and LOOP

* Loop may vary due to shade style



NOTES:

*DISTANCE TO LAMP (CF) 10'

*All compact fluorescent and LED housings may vary in size according to light source chosen.



D - MOUNTING ADD-ONS

LED - STEM AND ARM ADD-ONS

* FOR LED & COMPACT FLUORESCENT OPTIONS, CANOPIES WILL VARY IN SIZE DUE TO SIZE OF THE DRIVER/BALLAST THAT WILL BE LOCATED INSIDE OF THE CANOPY.

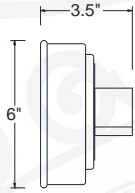

LWTM WEATHERTIGHT LED WALL MOUNT

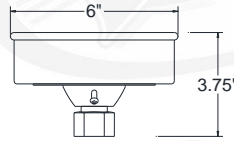

LSLC LED SLOPE CEILING CANOPY

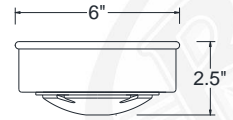

LSTC LED STEM MOUNT CANOPY

UNIVERSAL STEM AND ARM ADD-ONS

* EXAMPLE FOR MULTIPLE MOUNTING ADD-ONS:

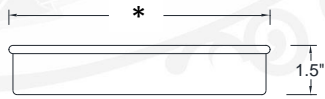
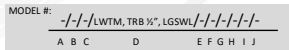

CNK CANOPY For MULTIPLE FIXTURES
*CNK dimensions vary on number of fixtures applied

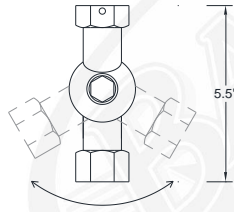

LGSWL 1/2" NPT SWIVEL
For all shades greater than 7" wide in diameter

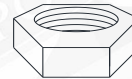

FH 1/2" FLAT HUB 1/2"
FH 3/4" FLAT HUB 3/4"



TRB 1/2"-4' Cable SUPPORT
TRB 3/4"-4' Cable SUPPORT

F – LIGHT SOURCE

BASELITE'S PUBLISHED LUMINAIRE PHOTOMETRIC TESTING WAS PERFORMED IN A 3-METER INTEGRATING SPHERE USING THE 4TT GEOMETRY METHOD. DATA IS CONSIDERED TO BE REPRESENTATIVE OF THE CONFIGURATIONS SHOWN, WITHIN THE TOLERANCES ALLOWED BY LIGHTING FACTS. TO OBTAIN AN IES FILE SPECIFIC TO YOUR PROJECT, PLEASE CONTACT THE FACTORY.

LIGHT EMITTING DIODE (LED)

LED 25W (MAX)- UL414, UL416, UL418, UL422

***IMPORTANT** – FOR LIGHT EMITTED DIODE (LED) LIGHT SOURCE OPTION, FIXTURES ARE LIMITED DUE TO SIZE OF THE FIXTURE AND THE CORD WATTAGE RESTRICTIONS. PLEASE SEE MAX WATTAGE AVAILABILITY. **EXAMPLE: /LED25W /**

OPTION	WATTAGE	LUMENS	CRI	VOLTAGE	DIMMING
LED10WF	10W	1280	>90	120-277 VAC	TRI-ELV *120V ONLY
LED12W	12W	1481	>90	120-277 VAC	See section "H"
LED25W	25W	2812	>90	120-277 VAC	See section "H"

@3500K

H – ELECTRICAL OPTION

LED DIMMING OPTIONS

LED10WF – ONLY AVAILABLE WITH **LDM120** - TRI-ELV DIMMING OPITON. ALL OTHER WATTAGES CAN CHOOSE FROM THE OPTIONS BELOW. CONTACT DRIVER MANUFACTURER FOR FURTHER SPECIFICATIONS.

LDM120 - TRIAC / ELV – INPUT 120 / 277V - DIMMING AT 120 VOLT ONLY

LDM0-10V – 0 – 10V – DIMMING AT 120 / 277 VOLTS



I – GLASS OPTIONS

*NOTE: MUST USE TEMPERED GLASS FOR LIGHT FIXTURES USING HIGH INTENSITY DISCHARGE (HID) LIGHT SOURCE OPTION.



CL3 3" CLEAR GLASS

CL4 4" CLEAR GLASS

CLT3 3" CLEAR TEMPERED

CLT4 4" CLEAR TEMPERED



PR3 3" PRISMATIC GLASS

PR4 4" PRISMATIC GLASS



RE3 3" RED GLASS

RE4 4" RED GLASS



BL3 3" BLUE GLASS

BL4 4" BLUE GLASS



FR3 3" FROSTED GLASS

FR4 4" FROSTED GLASS

FRT3 3" FROSTED TEMPERED

FRT4 4" FROSTED TEMPERED



AH3 3" AMBER HYDE GLASS

AH4 4" AMBER HYDE GLASS



GR3 3" GREEN GLASS

GR4 4" GREEN GLASS

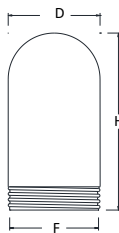

GLASS – DIMENSIONS	
3" GLASS	
Diameter	3.34"
Height	6.93"
Fitter	3.29"
4" GLASS	
Diameter	4.34"
Height	8.37"
Fitter	4.29"

GLASS – MAX WATTAGE	
3" GLASS	100W INC / LED12W
4" GLASS	200W INC / LED25W



BA 6" OPAL BALL
(100W INC MAX/LED12W)



BAX 9" CLEAR GLOBE
BAF 9" FROSTED GLOBE
(200W INC MAX/LED25W)



FN 8" CLEAR TEXTURED GLOBE
(150W INC MAX/LED25W)



BA7 7" CLEAR GLOBE

BA7F 7" FROSTED GLOBE
(100W INC MAX/LED25W)



PR8 8" PRISMATIC

PR8F 8" PRISMATIC FROSTED
(200W INC MAX/LED45W)



OC 8" OPAL TAPERED GLOBE
(60W INC MAX/LED25W)

J – ACCESSORIES

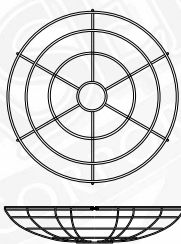

- GR14** 14" WIRE GRILL
- GR16** 16" WIRE GRILL
- GR18** 18" WIRE GRILL
- GR22** 22" WIRE GRILL

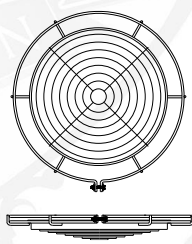

- LGR14** 14" LOUVERED GRILL
- LGR16** 16" LOUVERED GRILL
- LGR18** 18" LOUVERED GRILL
- LGR22** 22" LOUVERED GRILL

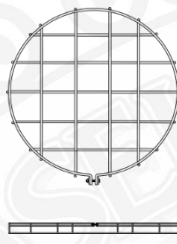

- FGR14** 14" FLAT GRILL
- FGR16** 16" FLAT GRILL
- FGR18** 18" FLAT GRILL
- FGR22** 22" FLAT GRILL



- CRL14** 14" CURVED POLYCARB LENS
- CRL16** 16" CURVED POLYCARB LENS
- CRL18** 18" CURVED POLYCARB LENS
- CRL22** 22" CURVED POLYCARB LENS

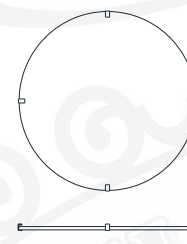

- FLE14** 14" FLAT CLEAR LENS
- FLE16** 16" FLAT CLEAR LENS
- FLE18** 18" FLAT CLEAR LENS
- FLE22** 22" FLAT CLEAR LENS

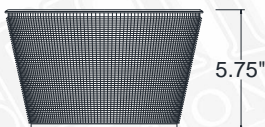

REF 9.5" DIAMETER REFRACTOR



UGR U- WIRE GUARD

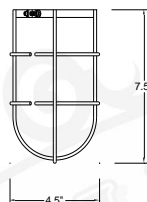

WG-1 WIRE GUARD

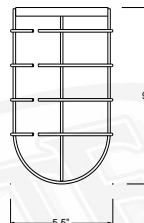

WG-2 WIRE GUARD
Available for shades
12" or higher

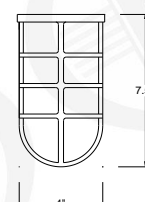

GU-1 CAST ALUMINUM GUARD

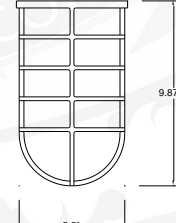

GU-2 CAST ALUMINUM GUARD
Available for shades 12" or higher