



# BASELITE – SUNDANCE SHADE – LED – SPEC SHEET



PROJECT NAME: \_\_\_\_\_ PROJECT TYPE: \_\_\_\_\_

MODEL #	/	/	/	/	/	/	/	/	/	/	/
	A	B	C	D	E	F	G	H	I	J	K
EXAMPLE:	SP403	41	E16	SQ ½"	43	45W	3K	LDM120	PR3	GR12	44

\*SKIP SECTION IF OPTION DOES NOT APPLY

NOTES:



WE18/55/BLC/100INC

## A - SHADES

### SUNDANCE SHADES

**WE14** - 25WLED (MAX)

**WE18** - 25WLED (MAX)

## B - FINISH OPTIONS

(SEE WEBSITE FOR SWATCH COLORS)  
(\*SEE NOTES FOR LIMITATIONS\*)

- 14, 15, 16, 17, 18, 19, 19P, 20, 20P, 20PB, 20SB, 21, 21P, 22, 22P, 23, 23P, 38, 39, 40, 41, 41.5, 42, 43, 44, 45, 46, 48, 49, 50, 51, 52, 53, 54, 55, 57, 58, 59, 60, 61, 62, 63, 64, 65, 66, 70, 71, 72, 73, 74, 75, 76, 77, 78, 79, 80, 81, 82, 83, 84, 85, 86, 87, 88, 89, 90, 91, 92, 93, 94, 95, 96, 97, 98, 99, 100, MG.

## C – MOUNTING OPTIONS

### ½" ARM EXTENSIONS

- E1, E2, E3, E4, B1, E16, E17, E18, E26, E27

### ¾" ARM EXTENSIONS

- E3A, E4A, E5, E6, E7, E8, E9, E10, E11, E12, E13, B15, B15S, E19, E20, E21, E25

### E14 - CREATE YOUR OWN

(BASELITE WILL TAKE YOUR SKETCH AND FABRICATE A CUSTOM ARM EXTENSION TO MEET YOUR NEEDS).

### ½" WALL MOUNT

- B13, WM13R, WM13X, B10, B11, B101

### ¾" WALL MOUNT

- B9, B9C, B12, WM10, WM11, WM14X, WM15, WM35X, WM55X, WM60X, WM61X WM70X, WM71X

### LED CORD MOUNT

- LBLC, LWHC, LTCB, LTCW, LTCHB, LTCHW, LTLB, LTLW, LTLB, LTLW, LRCB, LRCW, LRCHB, LRCHW, LFHB, LFHW, LHBLC, LHWHC, LCBLC, LCWHC, LCHB, LCHW

### STEM MOUNT

- ST6, ST12, ST18, ST24, ST36, ST48, STXX

## D – MOUNTING ADD-ONS

### LED ADD-ONS

- LWTM, LSLC, LSTC

### UNIVERSAL ADD-ONS

- SQ ½", SQ ¾", FH ½", FH ¾", TRB ½", TRB ¾", SWL, LGSWL, CNK, INB, RINB

## E – MOUNTING COLOR

SEE SECTION "B" FOR COLOR OPTIONS.

## F – LIGHT SOURCE

(SEE PAGE 4 FOR WATTAGE LIMITATIONS)

### LIGHT EMITTED DIODE (LED)

- LED10WF, LED12W, LED25W

\*NOTE – MAX WATTAGE IS LISTED NEXT TO THE SHADE MODEL NUMBER IN SECTION "A". ALL WATTAGES BELOW THAT ARE ALSO AVAILABLE FOR THE SAME MODEL NUMBER.

## G – LED COLOR TEMP

- 27K – 2700 KELVIN
- 3K – 3000 KELVIN
- 35K – 3500 KELVIN
- 4K – 4000 KELVIN
- 5K – 5000 KELVIN

## H – ELECTRICAL OPTION

(SEE PAGE 4 FOR DIMMING OPTION SPECIFICATIONS)

### LDM120

### LDM0-10

## I – GLASS OPTIONS

- CL3, CL4, CLT3, CLT4, BL3, BL4, RE3, RE4, GR3, GR4, AH3, AH4, FR3, FR4, FRT3, FRT4, PR3, PR4, BA, BAX, BAF, PR8, PR8F, FN, OC

## J – ACCESSORIES

- GR14, GR16, GR18, REF, UGR, LGR14, LGR16, LGR18, CRL14, CRL16, CRL18, FLE14, FLE16, FLE18, FGR14, FGR16, FGR18, GU-1, GU-2, WG-1, WG-2

## K – ACCESSORY COLOR

SEE SECTION "B" FOR COLOR OPTIONS.

## NOTES

- FINISH OPTIONS 75,76, 77, 83, 84, 88, 93 AND 98 ARE APPLIED BY HAND. THESE FINISHES WILL VARY IN CONSISTENCY.
- FINISH OPTIONS 38, 39, 40, 49, 54, 57, 58, 61, 62, 63, 70, 71, 72, 73, 78, 83, 84, 88, 92, 93, 98 ONLY AVAILABLE INSIDE AND OUT OF FIXTURE. OTHER FINISHES ARE WHITE INSIDE.
- FINISH OPTIONS FOR SHADES ≤ 10" IN DIAMETER ARE THE SAME INSIDE AND OUT OF FIXTURE. SHADES > 10" IN DIAMETER ARE WHITE ON THE INSIDE.
- FINISH OPTIONS 61, 62, 70, 71, 72, 73 ARE FINISHED WITH A SUPERCHROME ON THE INSIDE FOR ALL LED LIGHT SOURCE OPTIONS.
- COLOR CORDS ARE NOT APPLICABLE FOR LED OPTIONS.  
\*ALL ARMS COME WITH A CAST BACKPLATE (CB1/2", CB3/4", LWTM, CFWTM, ECT.).  
\*ACCORDING TO THE LIGHT SOURCE THE BACKPLATE MAY VARY IN SIZE. (EXAMPLE: LED LIGHT SOURCE WILL HAVE A DEEPER BACKPLATE TO HOUSE THE DRIVER.).  
\*ALL FIXTURES MOUNT TO A 4-O JUNCTION BOX.  
\*FIXTURE DIMENSIONS MAY VARY ± 0.25.  
\*CORD AND CANOPY COME IN THE SAME COLOR.

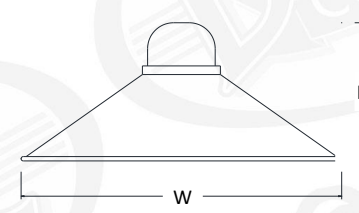

<b>WE14</b>	H-6"	W-14"
<b>WE18</b>	H-8"	W-18.5"



C - MOUNTING OPTIONS

1/2" ARM EXTENSIONS

\*ARMS RATED FOR WET LOCATION \* MAXIMUM SECTIONS OF ARMS ARE DIMENSIONED

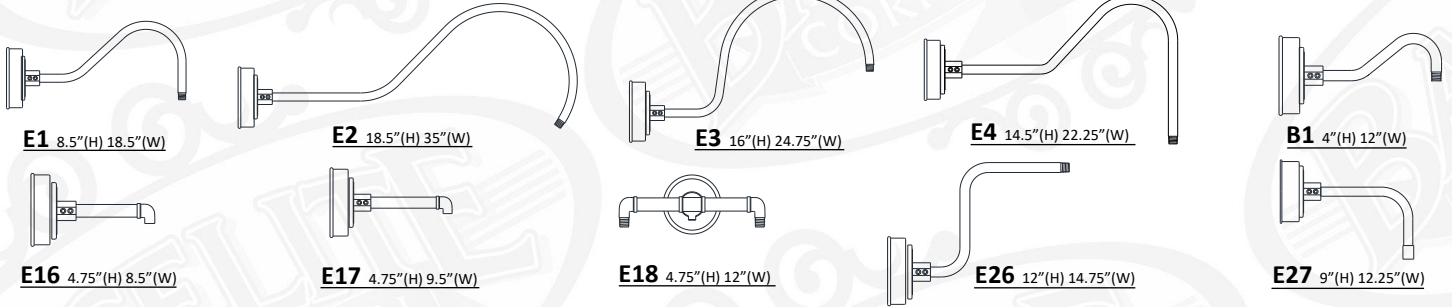

3/4" ARM EXTENSIONS

\*ARMS RATED FOR WET LOCATION \* MAXIMUM SECTIONS OF ARMS ARE DIMENSIONED

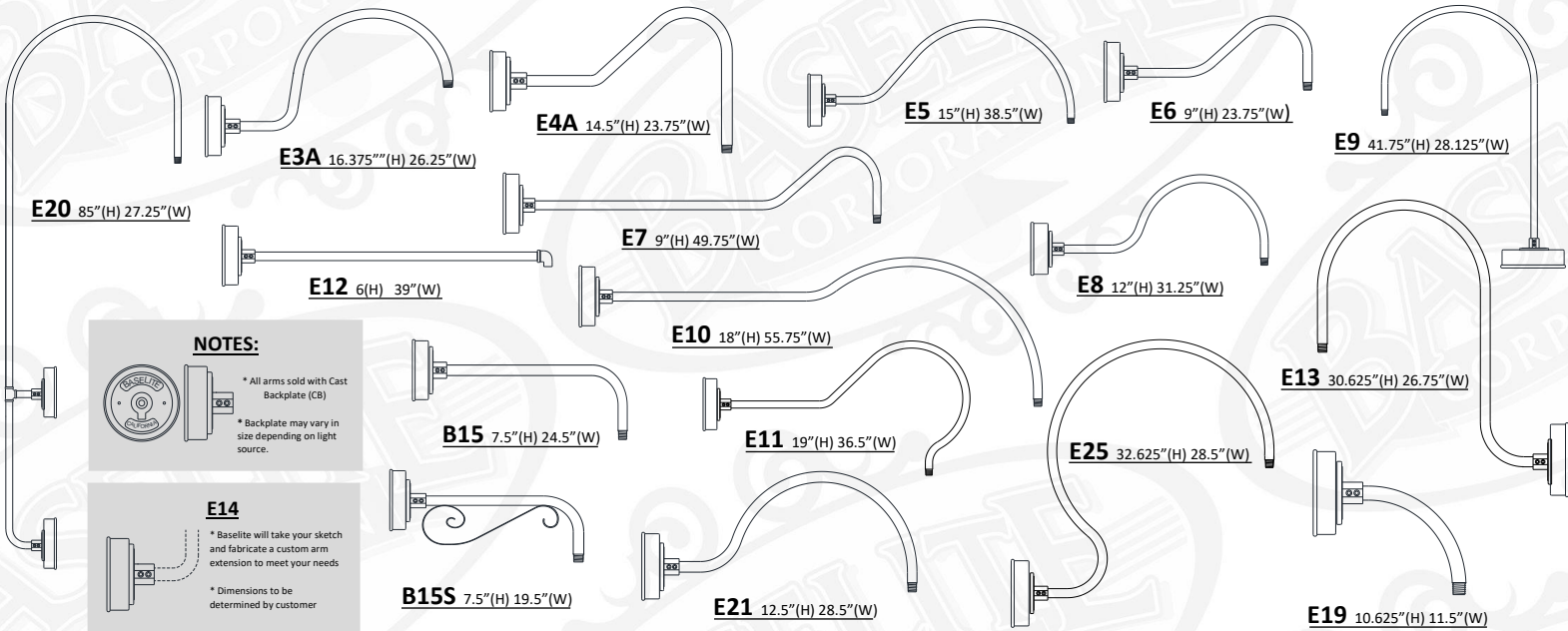

1/2" WALL MOUNTS

\*MOUNTS RATED FOR WET LOCATION \* MAXIMUM SECTIONS OF MOUNTS ARE DIMENSIONED

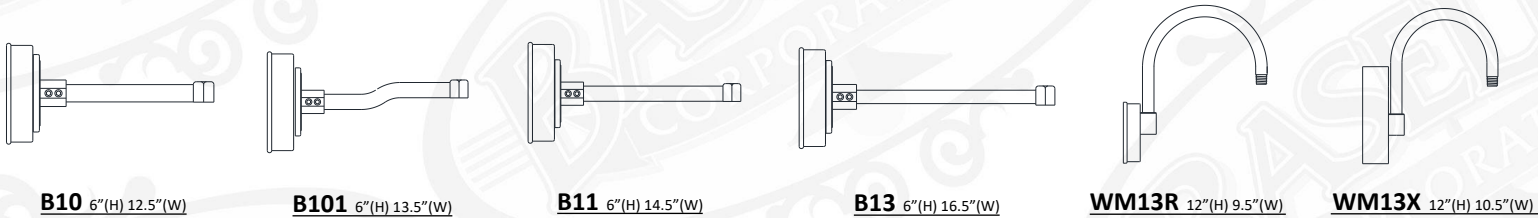

3/4" WALL MOUNTS

\*MOUNTS RATED FOR WET LOCATION \* MAXIMUM SECTIONS OF MOUNTS ARE DIMENSIONED

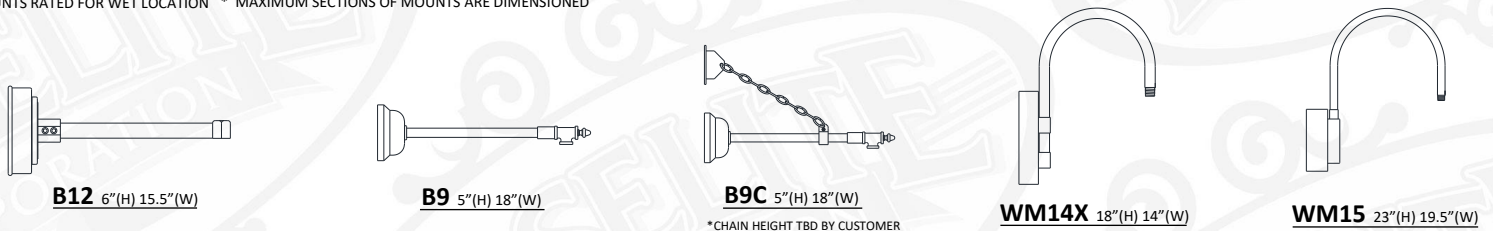



C - MOUNTING OPTIONS (CONTINUED)

3/4" WALL MOUNTS

\*MOUNTS RATED FOR WET LOCATION \* MAXIMUM SECTIONS OF MOUNTS ARE DIMENSIONED



**WM35X** 26"(H) 22"(W)



**WM55X** 19"(H) 27"(W)

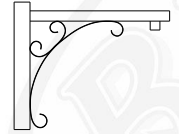

**WM60X** 18"(H) 22"(W)

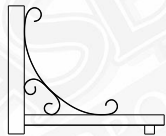

**WM61X** 18"(H) 22"(W)

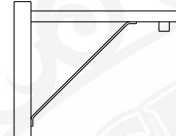

**WM70X** 18"(H) 22"(W)

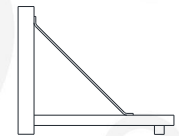

**WM71X** 18"(H) 22"(W)

STEM MOUNTS

\*STEMS RATED FOR DAMP LOCATION

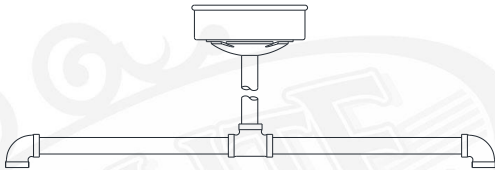

**DP24** DOUBLE PENDANT 20"(H) 24"(W)

\*DP24 COMES STANDARD WITH LSTC AND ST18



**ST(XX)** STEM- 1/2" NPT

XX = LENGTH OF STEM  
(EXAMPLE - "ST18" = STEM MOUNT 18" LENGTH)  
\*CANOPY NOT INCLUDED, ADD IN SECTION D  
\* 1/4" NPT AND 3/4" NPT AVAILABLE UPON REQUEST



**SC24** SCROLL STEM 33"(H) 26"(W)

\*SC24 COMES STANDARD WITH LSTC

LED CORD MOUNTS

\*FOR LED & COMPACT FLUORESCENT OPTIONS, CANOPIES WILL VARY IN SIZE DUE TO SIZE OF THE DRIVER/BALLAST THAT WILL BE LOCATED INSIDE OF THE CANOPY. \*CORDS RATED FOR DRY LOCATION  
\*CANOPY DIMENSIONS: 4" (H) 5.5" (W) \*CORD AND CANOPY COME IN THE SAME COLOR.

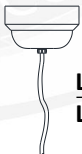

**LBLC** 8' BLACK CORD  
**LWHC** 8' WHITE CORD

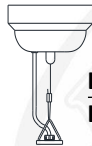

**LTCB** 8' BLACK CORD, CABLE, and LOOP  
**LTCW** 8' WHITE CORD, CABLE, and LOOP



**LTCHB** 8' BLACK CORD, 3' CHAIN, and LOOP  
**LTCHW** 8' WHITE CORD, 3' CHAIN, and LOOP



**LTLB** 8' BLACK TELEPHONE CORD AND CABLE  
**LTLW** 8' WHITE TELEPHONE CORD AND CABLE  
\* Not available with compact fluorescent



**LRCB** 8' BLACK CORD, CABLE, and LOOP  
**LRCW** 8' WHITE CORD, CABLE, and LOOP



**LRCHB** 8' BLACK CORD, 3' CHAIN, and LOOP  
**LRCHW** 8' WHITE CORD, 3' CHAIN, and LOOP



**LFHB** 8' BLACK CORD WITH FLAT HUB  
**LFHW** 8' WHITE CORD WITH FLAT HUB



**LCBLC** 8' BLACK CORD and CABLE  
**LCWHC** 8' WHITE CORD and CABLE



**LCHB** 8' BLACK CORD, 3' CHAIN, and LOOP  
**LCHW** 8' WHITE CORD, 3' CHAIN, and LOOP  
\* Loop may vary due to shade style

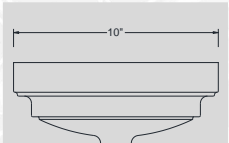

**NOTES:**  
\*DISTANCE TO LAMP (CF) 10'  
\*All compact fluorescent and LED housings may vary in size according to light source chosen.



## I – GLASS OPTIONS

\*NOTE: MUST USE TEMPERED GLASS FOR LIGHT FIXTURES USING HIGH INTENSITY DISCHARGE (HID) LIGHT SOURCE OPTION.



**CL3** 3" CLEAR GLASS

**CL4** 4" CLEAR GLASS

**CLT3** 3" CLEAR TEMPERED

**CLT4** 4" CLEAR TEMPERED



**PR3** 3" PRISMATIC GLASS

**PR4** 4" PRISMATIC GLASS



**RE3** 3" RED GLASS

**RE4** 4" RED GLASS



**BL3** 3" BLUE GLASS

**BL4** 4" BLUE GLASS



**FR3** 3" FROSTED GLASS

**FR4** 4" FROSTED GLASS

**FRT3** 3" FROSTED TEMPERED

**FRT4** 4" FROSTED TEMPERED



**AH3** 3" AMBER HYDE GLASS

**AH4** 4" AMBER HYDE GLASS



**GR3** 3" GREEN GLASS

**GR4** 4" GREEN GLASS

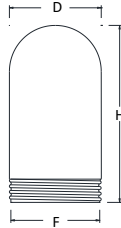

GLASS – DIMENSIONS	
3" GLASS	
Diameter	3.34"
Height	6.93"
Fitter	3.29"
4" GLASS	
Diameter	4.34"
Height	8.37"
Fitter	4.29"

GLASS – MAX WATTAGE	
3" GLASS	100W INC / LED12W
4" GLASS	200W INC / LED25W



**BA** 6" OPAL BALL  
(100W INC MAX/LED12W)



**BAX** 9" CLEAR GLOBE  
**BAF** 9" FROSTED GLOBE  
(200W INC MAX/LED25W)



**FN** 8" CLEAR TEXTURED GLOBE  
(150W INC MAX/LED25W)



**BA7** 7" CLEAR GLOBE

**BA7F** 7" FROSTED GLOBE  
(100W INC MAX/LED25W)



**PR8** 8" PRISMATIC

**PR8F** 8" PRISMATIC FROSTED  
(200W INC MAX/LED45W)



**OC** 8" OPAL TAPERED GLOBE  
(60W INC MAX/LED25W)

## J – ACCESSORIES

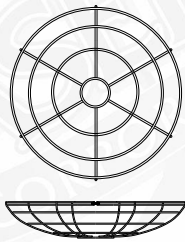

**GR14** 14" WIRE GRILL

**GR16** 16" WIRE GRILL

**GR18** 18" WIRE GRILL

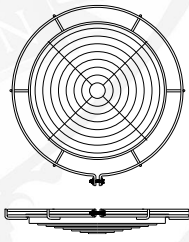

**LGR14** 14" LOUVERED GRILL

**LGR16** 16" LOUVERED GRILL

**LGR18** 18" LOUVERED GRILL

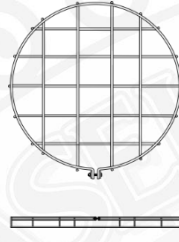

**FGR14** 14" FLAT GRILL

**FGR16** 16" FLAT GRILL

**FGR18** 18" FLAT GRILL



**CRL14** 14" CURVED POLYCARB LENSE

**CRL16** 16" CURVED POLYCARB LENSE

**CRL18** 18" CURVED POLYCARB LENSE

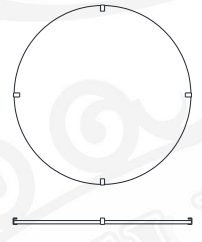

**FLE14** 14" FLAT CLEAR LENSE

**FLE16** 16" FLAT CLEAR LENSE

**FLE18** 18" FLAT CLEAR LENSE

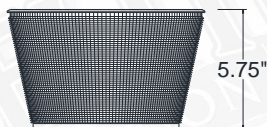

**REF** 9.5" DIAMETER REFRACTOR



**UGR** U- WIRE GUARD

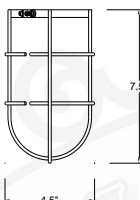

**WG-1** WIRE GUARD

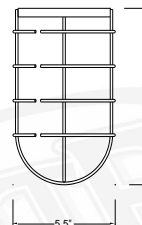

**WG-2** WIRE GUARD  
Available for shades  
12" or higher

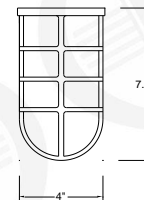

**GU-1** CAST ALUMINUM GUARD

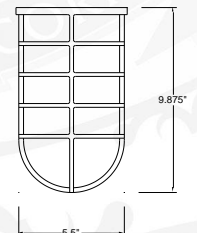

**GU-2** CAST ALUMINUM GUARD  
Available for shades 12" or higher