



# BASELITE – SUNDANCE SHADE – CF – SPEC SHEET



PROJECT NAME: \_\_\_\_\_ PROJECT TYPE: \_\_\_\_\_

MODEL #	/	/	/	/	/	/	/	/	/	/	/
	A	B	C	D	E	F	G	H	I	J	K
EXAMPLE:	SP403	41	E16	SQ ½"	43	45W	3K	LDM120	PR3	GR12	44

\*SKIP SECTION IF OPTION DOES NOT APPLY

NOTES:



WE18/55/BLC/100INC

## A - SHADES

### SUNDANCE SHADES

**WE14** - 32WCF (MAX)

**WE18** - 32WCF (MAX)

## B - FINISH OPTIONS

(SEE WEBSITE FOR SWATCH COLORS)  
(\*SEE NOTES FOR LIMITATIONS\*)

14, 15, 16, 17, 18, 19, 19P, 20, 20P, 20PB, 20SB, 21, 21P, 22, 22P, 23, 23P, 38, 39, 40, 41, 41.5, 42, 43, 44, 45, 46, 48, 49, 50, 51, 52, 53, 54, 55, 57, 58, 59, 60, 61, 62, 63, 64, 65, 66, 70, 71, 72, 73, 74, 75, 76, 77, 78, 79, 80, 81, 82, 83, 84, 85, 86, 87, 88, 89, 90, 91, 92, 93, 94, 95, 96, 97, 98, 99, 100, MG.

## C – MOUNTING OPTIONS

### ½" ARM EXTENSIONS

E1, E2, E3, E4, B1, E16, E17, E18, E26, E27

### ¾" ARM EXTENSIONS

E3A, E4A, E5, E6, E7, E8, E9, E10, E11, E12, E13, B15, B15S, E19, E20, E21, E25

### E14 - CREATE YOUR OWN

(BASELITE WILL TAKE YOUR SKETCH AND FABRICATE A CUSTOM ARM EXTENSION TO MEET YOUR NEEDS).

### ½" WALL MOUNT

B13, WM13R, WM13X, B10, B11, B101

### ¾" WALL MOUNT

B9, B9C, B12, WM10, WM11, WM14X, WM15, WM35X, WM55X, WM60X, WM61X WM70X, WM71X

### COMPACT FLUORESCENT CORD MOUNT

CFBLC, CFWHC, CFTCB, CFTCW, CFTCHB, CFTCHW, CFTLB, CFTLW, CFRCB, CFRCW, CFRCHB, CFRCHW, CFFHB, CFFHW, CFHBLC, CFHWHC, CFCBLC, CFCWHC, CFCFB, CFCWH

### STEM MOUNT

ST6, ST12, ST18, ST24, ST36, ST48, STXX

## D – MOUNTING ADD-ONS

### CF ADD-ONS

CFWTM, CFSLC, CFSTC

### UNIVERSAL ADD-ONS

SQ ½", SQ ¾", FH ½", FH ¾", TRB ½", TRB ¾", SWL, LGSWL, CNK, INB, RINB

## E – MOUNTING COLOR

SEE SECTION "B" FOR COLOR OPTIONS.

## F – LIGHT SOURCE

(SEE PAGE 4 FOR WATTAGE LIMITATIONS)

### COMPACT FLUORESCENT (CF)

26W, 32W

## G – LED COLOR TEMP

NOT AVAILABLE

## H – ELECTRICAL OPTION

(SEE PAGE 4 FOR DIMMING OPTION SPECIFICATIONS)

### CDM120

### CDM277

### CDM120/277

## I – GLASS OPTIONS

CL3, CL4, CLT3, CLT4, BL3, BL4, RE3, RE4, GR3, GR4, AH3, AH4, FR3, FR4, FRT3, FRT4, PR3, PR4, BA, BAX, BAF, PR8, PR8F, FN, OC

## J – ACCESSORIES

GR14, GR16, GR18, REF, UGR, LGR14, LGR16, LGR18, CRL14, CRL16, CRL18, FLE14, FLE16, FLE18, FGR14, FGR16, FGR18, GU-1, GU-2, WG-1, WG-2

## K – ACCESSORY COLOR

SEE SECTION "B" FOR COLOR OPTIONS.

## NOTES

(1). FINISH OPTIONS 75,76, 77, 83, 84, 88, 93 AND 98 ARE APPLIED BY HAND. THESE FINISHES WILL VARY IN CONSISTENCY.  
(2). FINISH OPTIONS 38, 39, 40, 49, 54, 57, 58, 61, 62, 63, 70, 71, 72, 73, 78, 83, 84, 88, 92, 93, 98 ONLY AVAILABLE INSIDE AND OUT OF FIXTURE. OTHER FINISHES ARE WHITE INSIDE.

(3). FINISH OPTIONS FOR SHADES ≤ 10" IN DIAMETER ARE THE SAME INSIDE AND OUT OF FIXTURE. SHADES > 10" IN DIAMETER ARE WHITE ON THE INSIDE.  
(4). FINISH OPTIONS 61, 62, 70, 71, 72, 73 ARE FINISHED WITH A SUPERCROME ON THE INSIDE FOR ALL LED LIGHT SOURCE OPTIONS.

(5). COLOR CORDS ARE NOT APPLICABLE FOR LED OPTIONS.

\*ALL ARMS COME WITH A CAST BACKPLATE (CB1/2", CB3/4", LWTM, CFWTM, ECT.).

\*ACCORDING TO THE LIGHT SOURCE THE BACKPLATE MAY VARY IN SIZE. (EXAMPLE: LED LIGHT SOURCE WILL HAVE A DEEPER BACKPLATE TO HOUSE THE DRIVER.).

\*ALL FIXTURES MOUNT TO A 4-O JUNCTION BOX.

\*FIXTURE DIMENSIONS MAY VARY ± 0.25.

\*CORD AND CANOPY COME IN THE SAME COLOR.

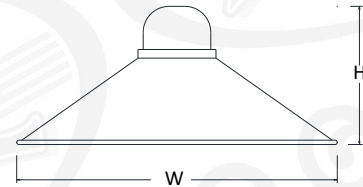

**WE14** H-6" W-14"  
**WE18** H-8" W-18.5"



**C - MOUNTING OPTIONS**

**1/2" ARM EXTENSIONS**

\*ARMS RATED FOR WET LOCATION \* MAXIMUM SECTIONS OF ARMS ARE DIMENSIONED

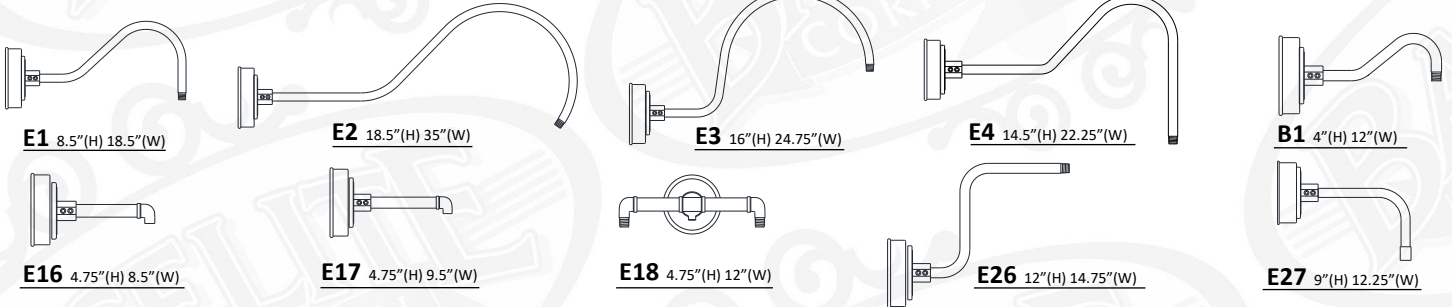

**3/4" ARM EXTENSIONS**

\*ARMS RATED FOR WET LOCATION \* MAXIMUM SECTIONS OF ARMS ARE DIMENSIONED

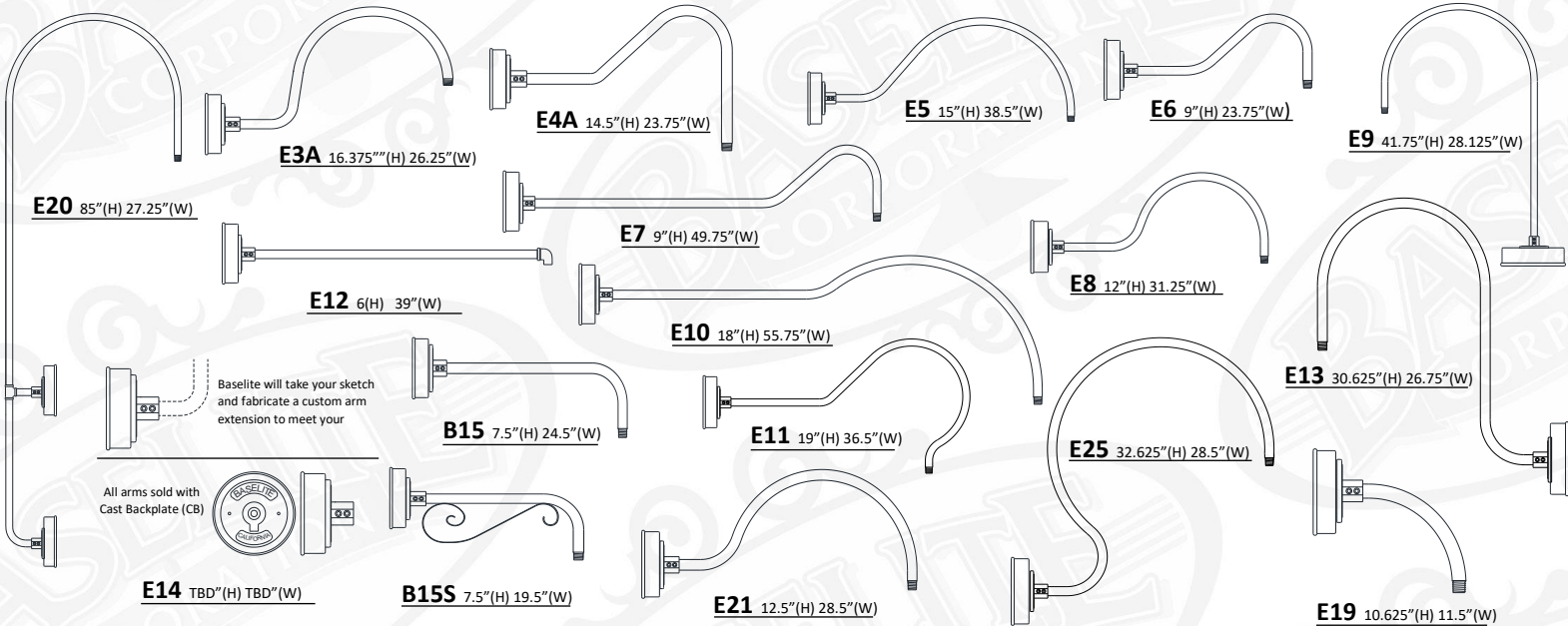

**1/2" WALL MOUNTS**

\*MOUNTS RATED FOR WET LOCATION \* MAXIMUM SECTIONS OF MOUNTS ARE DIMENSIONED

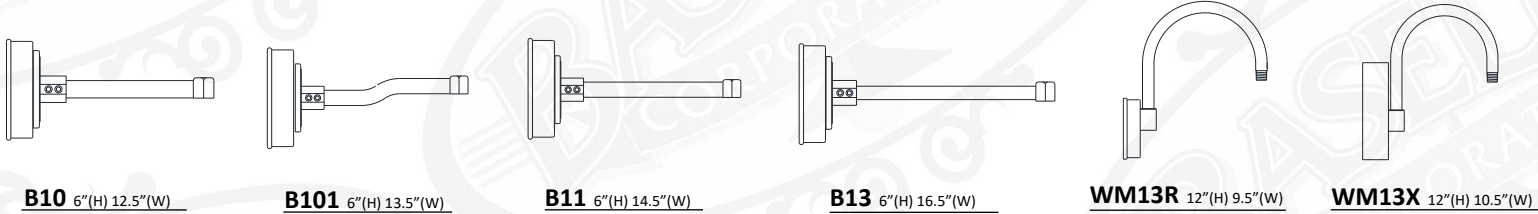

**3/4" WALL MOUNTS**

\*MOUNTS RATED FOR WET LOCATION \* MAXIMUM SECTIONS OF MOUNTS ARE DIMENSIONED

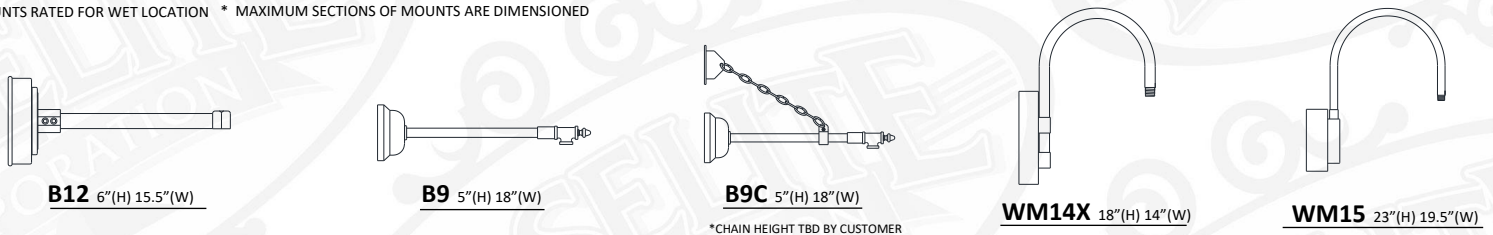





C - MOUNTING OPTIONS (CONTINUED)

3/4" WALL MOUNTS

\*MOUNTS RATED FOR WET LOCATION \* MAXIMUM SECTIONS OF MOUNTS ARE DIMENSIONED



**WM35X** 26"(H) 22"(W)



**WM55X** 19"(H) 27"(W)

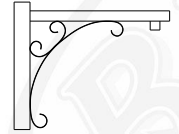

**WM60X** 18"(H) 22"(W)

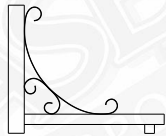

**WM61X** 18"(H) 22"(W)

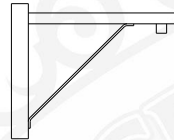

**WM70X** 18"(H) 22"(W)

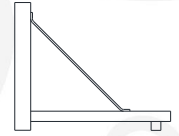

**WM71X** 18"(H) 22"(W)

STEM MOUNTS

\*STEMS RATED FOR DAMP LOCATION

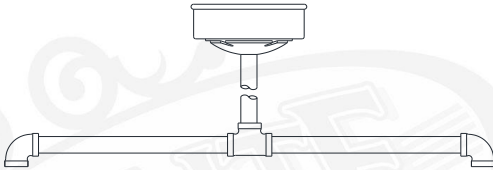

**DP24** DOUBLE PENDANT 20"(H) 24"(W)

\*DP24 COMES STANDARD WITH CFSTC AND ST18



**ST(XX)** STEM- 1/2" NPT

XX = LENGTH OF STEM  
(EXAMPLE - "ST18" = STEM MOUNT 18" LENGTH)  
\*CANOPY NOT INCLUDED, ADD IN SECTION D  
\* 1/4" NPT AND 3/4" NPT AVAILABLE UPON REQUEST



**SC24** SCROLL STEM 33"(H) 26"(W)

\*SC24 COMES STANDARD WITH CFSTC

COMPACT FLUORESCENT CORD MOUNTS

\*FOR LED & COMPACT FLUORESCENT OPTIONS, CANOPIES WILL VARY IN SIZE DUE TO SIZE OF THE DRIVER/BALLAST THAT WILL BE LOCATED INSIDE OF THE CANOPY.  
\*CORDS RATED FOR DRY LOCATION \*CANOPY DIMENSIONS: 4" (H) 5.5" (W) \*CORD AND CANOPY COME IN THE SAME COLOR.



**CFBLC** 8' BLACK CORD

**CFWHC** 8' WHITE CORD



**CFTCB** 8' BLACK CORD, CABLE, and LOOP

**CFTCW** 8' WHITE CORD, CABLE, and LOOP



**CFTCHB** 8' BLACK CORD, 3' CHAIN, and LOOP

**CFTCHW** 8' WHITE CORD, 3' CHAIN, and LOOP



**CFRCB** 8' BLACK CORD, CABLE, and LOOP

**CFRCW** 8' WHITE CORD, CABLE, and LOOP



**CFRCHB** 8' BLACK CORD, 3' CHAIN, and LOOP

**CFRCHW** 8' WHITE CORD, 3' CHAIN, and LOOP



**CFCHB** 8' BLACK CORD, 3' CHAIN, and LOOP

**CFCHW** 8' WHITE CORD, 3' CHAIN, and LOOP

\* Loop may vary due to shade style



**CFFHB** 8' BLACK CORD WITH FLAT HUB

**CFFHW** 8' WHITE CORD WITH FLAT HUB



**CFCBLC** 8' BLACK CORD and CABLE

**CFCWHC** 8' WHITE CORD and CABLE

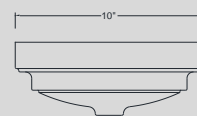

**NOTES:**

\*DISTANCE TO LAMP (CF) 10'

\*All compact fluorescent and LED housings may vary in size according to light source chosen.



**D - MOUNTING ADD-ONS**

**COMPACT FLUORESCENT STEM AND ARM ADD-ONS**

\* FOR LED & COMPACT FLUORESCENT OPTIONS, CANOPIES WILL VARY IN SIZE DUE TO SIZE OF THE DRIVER/BALLAST THAT WILL BE LOCATED INSIDE OF THE CANOPY.

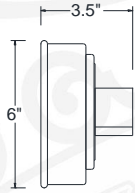

**CFWTM** WEATHERTIGHT CF WALL MOUNT

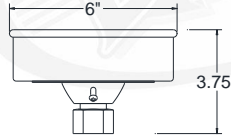

**CFSLC** CF SLOPE CEILING CANOPY

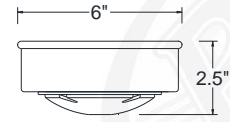

**CFSTC** CF STEM MOUNT CANOPY

**UNIVERSAL STEM AND ARM ADD-ONS**

\* EXAMPLE FOR MULTIPLE MOUNTING ADD-ONS:

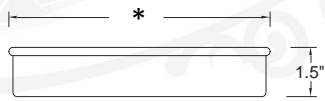
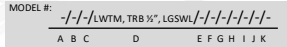

**CNK** CANOPY For MULTIPLE FIXTURES

\*CNK dimensions vary on number of fixtures applied

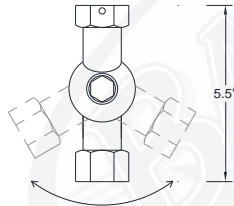

**LGSWL** 1/2" NPT SWIVEL  
For all shades greater than 7" wide in diameter

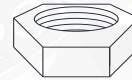

**FH 1/2"** FLAT HUB 1/2"  
**FH 3/4"** FLAT HUB 3/4"

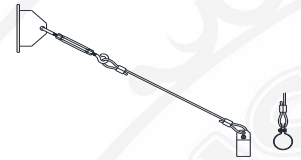

**TRB 1/2"-4' Cable** SUPPORT  
**TRB 3/4"-4' Cable** SUPPORT

**F - LIGHT SOURCE**

BASELITE'S PUBLISHED LUMINAIRE PHOTOMETRIC TESTING WAS PERFORMED IN A 3-METER INTEGRATING SPHERE USING THE 4TT GEOMETRY METHOD. DATA IS CONSIDERED TO BE REPRESENTATIVE OF THE CONFIGURATIONS SHOWN, WITHIN THE TOLERANCES ALLOWED BY LIGHTING FACTS. TO OBTAIN AN IES FILE SPECIFIC TO YOUR PROJECT, PLEASE CONTACT THE FACTORY.

**COMPACT FLUORESCENT (CF)**

**CF 26W, OR 32W(MAX) - WE14, WE18**

\*IMPORTANT - FOR COMPACT FLUORESCENT (CF) LIGHT SOURCE, FIXTURES ARE LIMITED DUE TO THE SIZE OF THE SHADE. PLEASE SEE THE CHART TO THE LEFT TO SEE WHAT WATTAGE IS COMPARABLE FOR EACH FIXTURE WHEN ORDERING.

EXAMPLE: /CF32W /

OPTION	WATTAGE	LUMENS	CRI	VOLTAGE	DIMMING
CF26W	26W	PER BULB SPECS	>90	120-277 VAC	See section "H"
CF32W	32W	PER BULB SPECS	>90	120-277 VAC	See section "H"

**H - ELECTRICAL OPTION**

MOST BASELITE'S ELECTRICAL OPTIONS ARE ONLY COMPATIBLE FOR CERTAIN FIXTURES. PLEASE SEE NOTES BELOW AND FOR FURTHER DETAILS CONTACT THE FACTORY. FOR DIMMING BALLAST OPTION, PLEASE CHOOSE MARK X OR MARK VII, SO RESTRICTIONS APPLY DUE TO THE SIZE OF THE BALLAST AND FIXTURE.

**COMPACT FLUORESCENT DIMMING OPTIONS**

PROVIDED WITH ADVANCE TRANSFORMER, PLEASE CHOOSE MARK 10 OR MARK 7 WITH SPECIFIED VOLTAGE FROM THE LIST BELOW. CONTACT BALLAST MANUFACTURER FOR SPECIFICATIONS.

**CDM7-120/277** - ADVANCE MARK 7 0-10v ELECTRICAL BALLST - 120/277 VOLT

**CDM10-120** - ADVANCE MARK 10 ELECTRICAL BALLST - 120 VOLT

**CDM10-277** - ADVANCE MARK 10 ELECTRICAL BALLST - 277 VOLT





**I – GLASS OPTIONS**

\*NOTE: MUST USE TEMPERED GLASS FOR LIGHT FIXTURES USING HIGH INTENSITY DISCHARGE (HID) LIGHT SOURCE OPTION.



**CL3** 3" CLEAR GLASS



**PR3** 3" PRISMATIC GLASS



**RE3** 3" RED GLASS



**BL3** 3" BLUE GLASS

**CL4** 4" CLEAR GLASS

**PR4** 4" PRISMATIC GLASS

**RE4** 4" RED GLASS

**BL4** 4" BLUE GLASS

**CLT3** 3" CLEAR TEMPERED

**CLT4** 4" CLEAR TEMPERED



**FR3** 3" FROSTED GLASS



**AH3** 3" AMBER HYDE GLASS



**GR3** 3" GREEN GLASS

**FR4** 4" FROSTED GLASS

**AH4** 4" AMBER HYDE GLASS

**GR4** 4" GREEN GLASS

**FRT3** 3" FROSTED TEMPERED

**FRT4** 4" FROSTED TEMPERED

GLASS – DIMENSIONS	
3" GLASS	
Diameter	3.34"
Height	6.93"
Fitter	3.29"
4" GLASS	
Diameter	4.34"
Height	8.37"
Fitter	4.29"

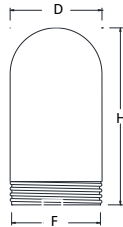

GLASS – MAX WATTAGE	
3" GLASS –	100W INC / LED12W
4" GLASS –	200W INC / LED25W



**BA** 6" OPAL BALL  
(100W INC MAX/LED12W)



**BAX** 9" CLEAR GLOBE  
**BAF** 9" FROSTED GLOBE  
(200W INC MAX/LED25W)



**FN** 8" CLEAR TEXTURED GLOBE  
(150W INC MAX/LED25W)



**BA7** 7" CLEAR GLOBE



**PR8** 8" PRISMATIC



**OC** 8" OPAL TAPERED GLOBE  
(60W INC MAX/LED25W)

**BA7F** 7" FROSTED GLOBE  
(100W INC MAX/LED25W)

**PR8F** 8" PRISMATIC FROSTED  
(200W INC MAX/LED45W)

**J – ACCESSORIES**

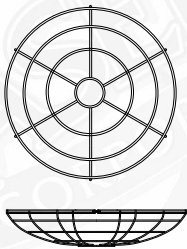

**GR14** 14" WIRE GRILL

**GR16** 16" WIRE GRILL

**GR18** 18" WIRE GRILL

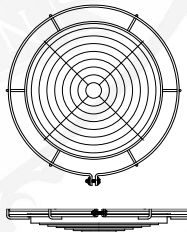

**LGR14** 14" LOUVERED GRILL

**LGR16** 16" LOUVERED GRILL

**LGR18** 18" LOUVERED GRILL

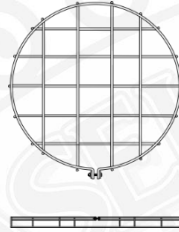

**FGR14** 14" FLAT GRILL

**FGR16** 16" FLAT GRILL

**FGR18** 18" FLAT GRILL



**CRL14** 14" CURVED POLYCARB LENSE

**CRL16** 16" CURVED POLYCARB LENSE

**CRL18** 18" CURVED POLYCARB LENSE

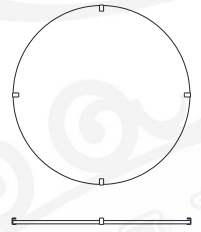

**FLE14** 14" FLAT CLEAR LENSE

**FLE16** 16" FLAT CLEAR LENSE

**FLE18** 18" FLAT CLEAR LENSE

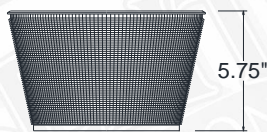

**REF** 9.5" DIAMETER REFRACTOR



**UGR** U- WIRE GUARD

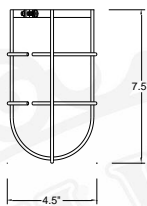

**WG-1** WIRE GUARD

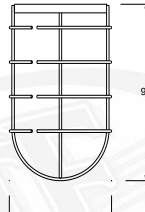

**WG-2** WIRE GUARD

Available for shades  
12" or higher

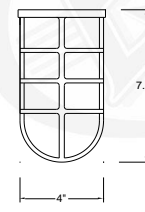

**GU-1** CAST ALUMINUM GUARD

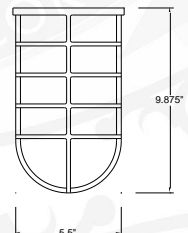

**GU-2** CAST GUARD

Available for shades  
12" or higher