



BASELITE – ROADHOUSE – CF – SPECIFICATION SHEET



PROJECT NAME: _____ PROJECT TYPE: _____

MODEL #	/	/	/	/	/	/	/	/	/	/	/
	A	B	C	D	E	F	G	H	I	J	K
EXAMPLE:	MC12	41	B10	SQ ½"	43	25W	3K	LDM120	CL3	GR12	44

*SKIP SECTION IF OPTION DOES NOT APPLY

NOTES:



MC12/40/GU-1/CL3/WM26/40/100INC

A - SHADES

- ROADHOUSE**
- MC8 - 32WCF (MAX)
 - MCA8 - 32WCF (MAX)
 - MC12 - 42WCF (MAX)
 - MCA12 - 42WCF (MAX)
 - MC16 - 42WCF (MAX)
 - MCA16 - 42WCF (MAX)
 - MC18 - 42WCF (MAX)
 - MCA18 - 42WCF (MAX)
 - MC20 - 42WCF (MAX)
 - MCA20 - 42WCF (MAX)
 - MCF12 - 42WCF (MAX)
 - MCAF12 - 42WCF (MAX)
 - MCL12 - 42WCF (MAX)
 - IMC20 - 42WCF (MAX)
 - 3MC12E1 - 42WCF (MAX)

B - FINISH OPTIONS

(SEE WEBSITE FOR SWATCH COLORS)
 (*SEE NOTES FOR LIMITATIONS*)

14, 15, 16, 17, 18, 19, 19P, 20, 20P, 20PB, 20SB, 21, 21P, 22, 22P, 23, 23P, 38, 39, 40, 41, 41.5, 42, 43, 44, 45, 46, 48, 49, 50, 51, 52, 53, 54, 55, 57, 58, 59, 60, 61, 62, 63, 64, 65, 66, 70, 71, 72, 73, 74, 75, 76, 77, 78, 79, 80, 81, 82, 83, 84, 85, 86, 87, 88, 89, 90, 91, 92, 93, 94, 95, 96, 97, 98, 99, 100, MG.

C - MOUNTING OPTIONS

- ½" ARM EXTENSIONS**
 E1, E2, E3, E4, B1, E16, E17, E27
- ¾" ARM EXTENSIONS**
 E3A, E4A, E5, E6, E7, E8, E9, E10, E11, E12, E13, B15, B15S, E19, E20, E21, E25
- E14 - CREATE YOUR OWN**
 (BASELITE WILL TAKE YOUR SKETCH AND FABRICATE A CUSTOM ARM EXTENSION TO MEET YOUR NEEDS).
- ½" WALL MOUNT**
 B13, WM13R, WM13X, B10, B11, B101
- ¾" WALL MOUNT**
 B9, B9C, B12, WM10, WM11, WM14X, WM15, WM35X, WM55X, WM60X, WM61X WM70X, WM71X
- COMPACT FLUORESCENT CORD MOUNT**
 CFBLC, CFWHC, CFTCB, CFTCW, CFTCHB, CFTCHW, CFTLB, CFTLW, CFRCB, CFRCW, CFRCHB, CFRCHW, CFFHB, CFFHW, CFHBL, CFHWHC, CFCBLC, CFCWHC, CFCWB, CFCHW
- STEM MOUNT**
 ST6, ST12, ST18, ST24, ST36, ST48, STXX

D - MOUNTING ADD-ONS

- CF ADD-ONS**
 CFWTM, CFSLC, CFSTC
- UNIVERSAL ADD-ONS**
 SQ ½", SQ ¾", FH ½", FH ¾", TRB ½", TRB ¾", SWL, LGSWL, CNK, INB, RINB

E - MOUNTING COLOR

SEE SECTION "B" FOR COLOR OPTIONS.

F - LIGHT SOURCE

(SEE PAGE 4 FOR WATTAGE LIMITATIONS)

COMPACT FLOURESCENT (CF)
 26W, 32W, 42W

*NOTE - MAX WATTAGE IS LISTED NEXT TO THE SHADE MODEL NUMBER IN SECTION "A". ALL LOWER WATTAGES ARE ALSO AVAILABLE FOR THE SAME MODEL NUMBER.

G - LED COLOR TEMP

NOT AVAILABLE

H - ELECTRICAL OPTION

(SEE PAGE 4 FOR DIMMING OPTION SPECIFICATIONS)

CDM120
CDM277
CDM120/277

I - GLASS OPTIONS

CL3, CL4, CLT3, CLT4, BL3, BL4, RE3, RE4, GR3, GR4, AH3, AH4, FR3, FR4, FRT3, FRT4, PR3, PR4, BA, BAX, BAF, PR8, PR8F, FN, OC

J - ACCESSORIES

GR8, GR12, GR16, GR18, GR20, REF, UGR, LGR8, LGR12, LGR16, LGR18, LGR20, CRL8, CRL12, CRL16, CRL18, CRL20, FLE8, FLE12, FLE16, FLE18, FLE20, FGR8, FGR12, FGR16, FGR18, FGR20, GU-1, GU-2, WG-1, WG-2

K - ACCESSORY COLOR

SEE SECTION "B" FOR COLOR OPTIONS.

NOTES

- (1). FINISH OPTIONS 75,76, 77, 83, 84, 88, 93 AND 98 ARE APPLIED BY HAND. THESE FINISHES WILL VARY IN CONSISTENCY.
 - (2). FINISH OPTIONS 38, 39, 40, 49, 54, 57, 58, 61, 62, 63, 70, 71, 72, 73, 78, 83, 84, 88, 92, 93, 98 ONLY AVAILABLE INSIDE AND OUT OF FIXTURE. OTHER FINISHES ARE WHITE INSIDE.
 - (3). FINISH OPTIONS 61, 62, 70, 71, 72, 73 ARE FINISHED WITH A SUPERCHROME ON THE INSIDE FOR ALL LED LIGHT SOURCE OPTIONS.
 - (4). FINISH OPTIONS FOR SHADES ≤ 10" IN DIAMETER ARE THE SAME INSIDE AND OUT OF FIXTURE. SHADES > 10" IN DIAMETER ARE WHITE ON THE INSIDE.
 - (5). COLOR CORDS ARE NOT APPLICABLE FOR LED OPTIONS.
- *ALL ARMS COME WITH A CAST BACKPLATE (CB1/2", CB3/4", LWTM, CFWTM, ECT.).
- *ACCORDING TO THE LIGHT SOURCE THE BACKPLATE MAY VARY IN SIZE. (EXAMPLE: LED LIGHT SOURCE WILL HAVE A DEEPER BACKPLATE TO HOUSE THE DRIVER.).
- *ALL FIXTURES MOUNT TO A 4-0 JUNCTION BOX.
- *FIXTURE DIMENSIONS MAY VARY ± 0.25.
- *CORD AND CANOPY COME IN THE SAME COLOR.

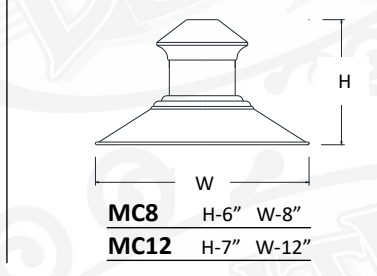
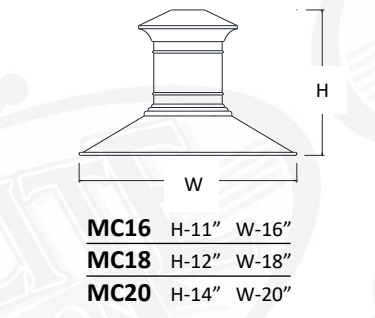
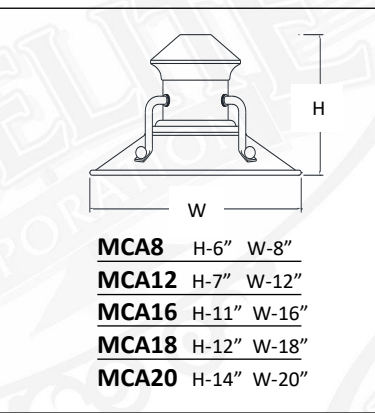
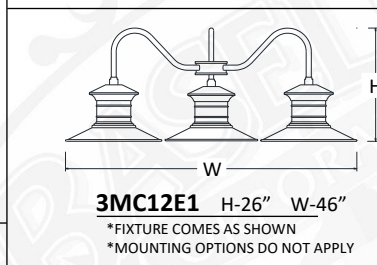
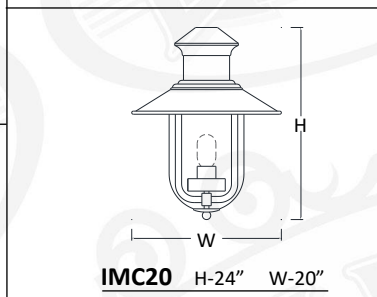
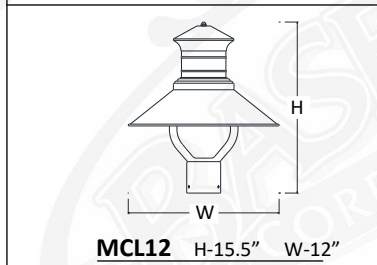
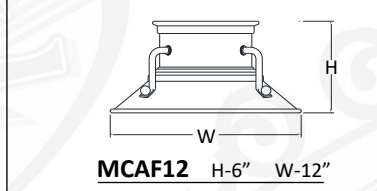
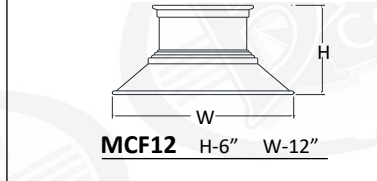



C - MOUNTING OPTIONS

1/2" ARM EXTENSIONS

*ARMS RATED FOR WET LOCATION * MAXIMUM SECTIONS OF ARMS ARE DIMENSIONED

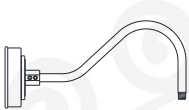

E1 8.5"(H) 18.5"(W)



E2 18.5"(H) 35"(W)

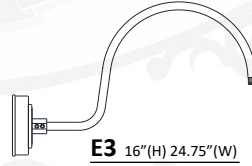

E3 16"(H) 24.75"(W)

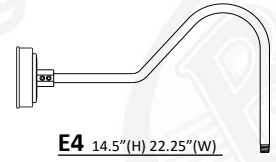

E4 14.5"(H) 22.25"(W)

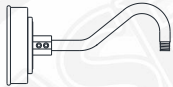

B1 4"(H) 12"(W)

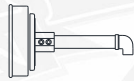

E16 4.75"(H) 8.5"(W)

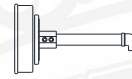

E17 4.75"(H) 9.5"(W)

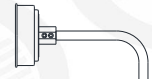

E27 9"(H) 12.25"(W)

3/4" ARM EXTENSIONS

*ARMS RATED FOR WET LOCATION * MAXIMUM SECTIONS OF ARMS ARE DIMENSIONED



E20 85"(H) 27.25"(W)

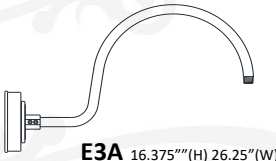

E3A 16.375"(H) 26.25"(W)

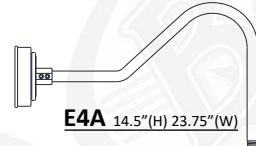

E4A 14.5"(H) 23.75"(W)



E5 15"(H) 38.5"(W)

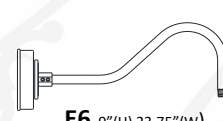

E6 9"(H) 23.75"(W)



E9 41.75"(H) 28.125"(W)

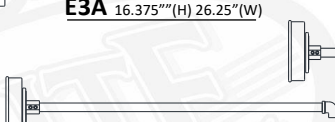

E12 6(H) 39"(W)

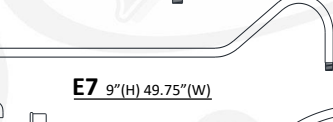

E7 9"(H) 49.75"(W)

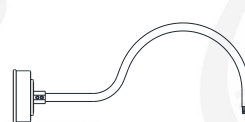

E8 12"(H) 31.25"(W)



E13 30.625"(H) 26.75"(W)

Baselite will take your sketch and fabricate a custom arm extension to meet your



All arms sold with Cast Backplate (CB)

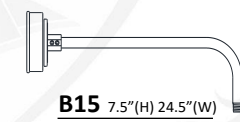

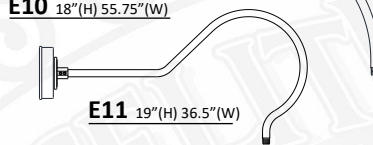

B15 7.5"(H) 24.5"(W)

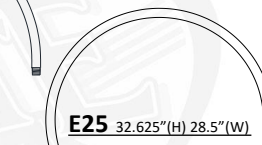

E10 18"(H) 55.75"(W)

E11 19"(H) 36.5"(W)



E25 32.625"(H) 28.5"(W)



B15S 7.5"(H) 19.5"(W)

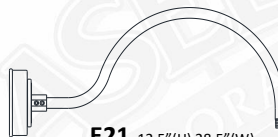

E21 12.5"(H) 28.5"(W)



E19 10.625"(H) 11.5"(W)

E14 TBD"(H) TBD"(W)

1/4" WALL MOUNT

*MOUNTS RATED FOR WET LOCATION * MAXIMUM SECTIONS OF MOUNTS ARE DIMENSIONED

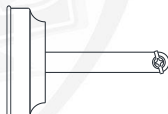

WM19 6"(H) 8.25"(W)

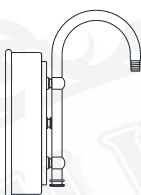

WM25 9"(H) 5.5"(W)

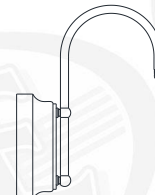

WM26 12"(H) 9"(W)



C - MOUNTING OPTIONS (CONTINUED)

1/2" WALL MOUNTS

*MOUNTS RATED FOR WET LOCATION * MAXIMUM SECTIONS OF MOUNTS ARE DIMENSIONED

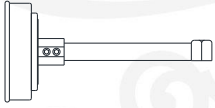

B10 6"(H) 12.5"(W)

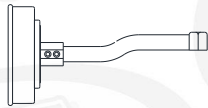

B101 6"(H) 13.5"(W)

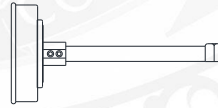

B11 6"(H) 14.5"(W)



B13 6"(H) 16.5"(W)

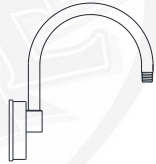

WM13R 12"(H) 9.5"(W)

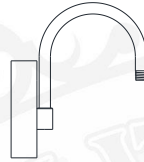

WM13X 12"(H) 10.5"(W)

3/4" WALL MOUNTS

*MOUNTS RATED FOR WET LOCATION * MAXIMUM SECTIONS OF MOUNTS ARE DIMENSIONED



B12 6"(H) 15.5"(W)



B9 5"(H) 18"(W)

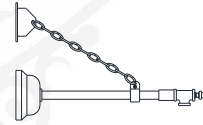

B9C 5"(H) 18"(W)
*CHAIN HEIGHT TBD BY CUSTOMER

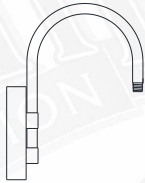

WM14X 18"(H) 14"(W)

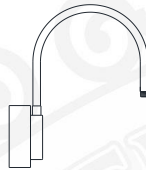

WM15 23"(H) 19.5"(W)



WM35X 26"(H) 22"(W)



WM55X 19"(H) 27"(W)

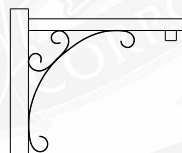

WM60X 18"(H) 22"(W)

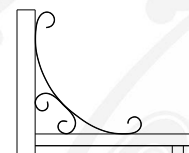

WM61X 18"(H) 22"(W)

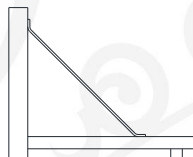

WM71X 18"(H) 22"(W)

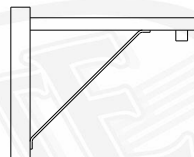

WM70X 18"(H) 22"(W)

C - MOUNTING OPTIONS (CONTINUED)

CF - STEM MOUNTS

*STEMS RATED FOR DAMP LOCATION

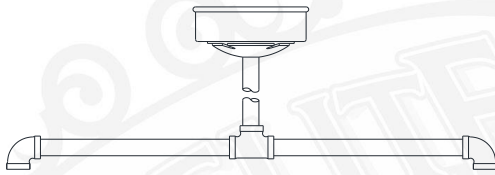

DP24 DOUBLE PENDANT 20"(H) 24"(W)
*DP24 COMES STANDARD WITH STC AND ST18



ST(XX) STEM- 1/2" NPT
XX = LENGTH OF STEM
(EXAMPLE - "ST18" = STEM MOUNT 18" LENGTH)
*CANOPY NOT INCLUDED, ADD IN SECTION D
* 1/4" NPT AND 3/4" NPT AVAILABLE UPON REQUEST

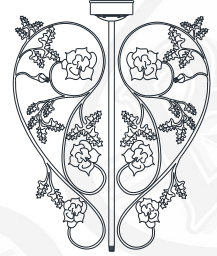

SC24 SCROLL STEM 33"(H) 24"(W)
*SC24 COMES STANDARD WITH STC

CF - CORD MOUNTS

*FOR LED & COMPACT FLUORESCENT OPTIONS, CANOPIES WILL VARY IN SIZE DUE TO SIZE OF THE DRIVER/BALLAST THAT WILL BE LOCATED INSIDE OF THE CANOPY.
*CORDS RATED FOR DRY LOCATION *CANOPY DIMENSIONS: 4" (H) 5.5" (W) *CORD AND CANOPY COME IN THE SAME COLOR.



CFBLC 8' BLACK CORD
CFWHC 8' WHITE CORD



CFTCB 8' BLACK CORD, CABLE, and LOOP
CFTCW 8' WHITE CORD, CABLE, and LOOP



CFTCHB 8' BLACK CORD, 3' CHAIN, and LOOP
CFTCHW 8' WHITE CORD, 3' CHAIN, and LOOP



CFRCB 8' BLACK CORD, CABLE, and LOOP
CFRCW 8' WHITE CORD, CABLE, and LOOP



CFRCHB 8' BLACK CORD, 3' CHAIN, and LOOP
CFRCHW 8' WHITE CORD, 3' CHAIN, and LOOP

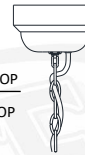

CFCHB 8' BLACK CORD, 3' CHAIN, and LOOP
CFCHW 8' WHITE CORD, 3' CHAIN, and LOOP

* Loop may vary due to shade style



LFHB 8' BLACK CORD WITH FLAT HUB
LFHW 8' WHITE CORD WITH FLAT HUB



CFCBLC 8' BLACK CORD and CABLE
CFCWHC 8' WHITE CORD and CABLE

NOTES:

*DISTANCE TO LAMP (CF) 10'

*All compact fluorescent and LED housings may vary in size according to light source chosen.

D - MOUNTING ADD-ONS

CF - STEM AND ARM ADD-ONS

* FOR LED & COMPACT FLUORESCENT OPTIONS, CANOPIES WILL VARY IN SIZE DUE TO SIZE OF THE DRIVER/BALLAST THAT WILL BE LOCATED INSIDE OF THE CANOPY.

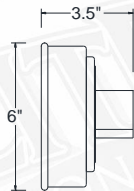

CFWTM WEATHERTIGHT LED WALL MOUNT

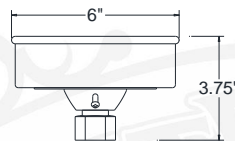

CFSLC LED SLOPE CEILING CANOPY



CFSTC LED STEM MOUNT CANOPY



D - MOUNTING ADD-ONS (CONTINUED)

UNIVERSAL STEM AND ARM ADD-ONS

* EXAMPLE FOR MULTIPLE MOUNTING ADD-ONS: MODEL #: - / - / - / WTM, TRB 1/2", LGSWL / - / - / - / - / - / - / - /
 A B C D E F G H I J K



CNK CANOPY FOR MULTIPLE FIXTURES
 *CNK dimensions vary on number of fixtures applied



FH 1/2" FLAT HUB 1/2"
FH 3/4" FLAT HUB 3/4"

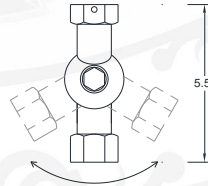

LGSWL 1/2" NPT SWIVEL
 For all shades greater than 7" wide in diameter



TRB 1/2"-4' Cable SUPPORT
TRB 3/4"-4' Cable SUPPORT

F – LIGHT SOURCE

BASELITE'S PUBLISHED LUMINAIRE PHOTOMETRIC TESTING WAS PERFORMED IN A 3-METER INTEGRATING SPHERE USING THE 4TT GEOMETRY METHOD. DATA IS CONSIDERED TO BE REPRESENTATIVE OF THE CONFIGURATIONS SHOWN, WITHIN THE TOLERANCES ALLOWED BY LIGHTING FACTS. TO OBTAIN AN IES FILE SPECIFIC TO YOUR PROJECT, PLEASE CONTACT THE FACTORY.

COMPACT FLOURESCENT (CF)

CF 26W, OR 32W(MAX)- MC8, MCA8
CF 26W, 32W, OR 42(MAX)- IMC20, MCF12, MCAF12, MC12, MCA12, MCL12, MC16, MCA16, MC18, MCA18, MC20, MCA20

*IMPORTANT – FOR COMPACT FLOURESCENT (CF) LIGHT SOURCE, FIXTURES ARE LIMITED DUE TO THE SIZE OF THE SHADE. PLEASE SEE THE CHART TO THE LEFT TO SEE WHAT WATTAGE IS COMPARABLE FOR EACH FIXTURE WHEN ORDERING.

EXAMPLE: / CF42W /

OPTION	WATTAGE	LUMENS	CRI	VOLTAGE	DIMMING
CF26W	26W	PER BULB SPECS	>90	120-277 VAC	See section "H"
CF32W	32W	PER BULB SPECS	>90	120-277 VAC	See section "H"
CF42W	42W	PER BULB SPECS	>90	120-277 VAC	See section "H"

H – ELECTRICAL OPTIONS

MOST BASELITE'S ELECTRICAL OPTIONS ARE ONLY COMPATIBLE FOR CERTAIN FIXTURES. PLEASE SEE NOTES BELOW AND FOR FURTHER DETAILS CONTACT THE FACTORY. FOR DIMMING BALLAST OPTION, PLEASE CHOOSE MARK X OR MARK VII, SO RESTRICTIONS APPLY DUE TO THE SIZE OF THE BALLAST AND FIXTURE.

COMPACT FLUORESCENT DIMMING OPTIONS

PROVIDED WITH ADVANCE TRANSFORMER, PLEASE CHOOSE MARK 10 OR MARK 7 WITH SPECIFIED VOLTAGE FROM THE LIST BELOW. CONTACT BALLAST MANUFACTURER FOR SPECIFICATIONS.

- CDM7-120/277** - ADVANCE MARK 7 0-10v ELECTRICAL BALLST – 120/277 VOLT
- CDM10-120** - ADVANCE MARK 10 ELECTRICAL BALLST – 120 VOLT
- CDM10-277** - ADVANCE MARK 10 ELECTRICAL BALLST – 277 VOLT

I – GLASS OPTIONS

*NOTE: MUST USE TEMPERED GLASS FOR LIGHT FIXTURES USING HIGH INTENSITY DISCHARGE (HID) LIGHT SOURCE OPTION.



CL3 3" CLEAR GLASS

CL4 4" CLEAR GLASS

CLT3 3" CLEAR TEMPERED

CLT4 4" CLEAR TEMPERED



PR3 3" PRISMATIC GLASS

PR4 4" PRISMATIC GLASS



RE3 3" RED GLASS

RE4 4" RED GLASS



BL3 3" BLUE GLASS

BL4 4" BLUE GLASS



FR3 3" FROSTED GLASS

FR4 4" FROSTED GLASS

FRT3 3" FROSTED TEMPERED

FRT4 4" FROSTED TEMPERED



AH3 3" AMBER HYDE GLASS

AH4 4" AMBER HYDE GLASS



GR3 3" GREEN GLASS

GR4 4" GREEN GLASS

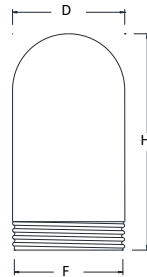

GLASS – DIMENSIONS

3" GLASS	
Diameter	3.34"
Height	6.93"
Fitter	3.29"
4" GLASS	
Diameter	4.34"
Height	8.37"
Fitter	4.29"

GLASS – MAX WATTAGE	
3" GLASS – 100W INC / LED12W	
4" GLASS – 200W INC / LED25W	



BA 6" OPAL BALL
(100W INC MAX/LED12W)



BAX 9" CLEAR GLOBE
BAF 9" FROSTED GLOBE
(200W INC MAX/LED25W)



FN 8" CLEAR TEXTURED GLOBE
(150W INC MAX/LED25W)



BA7 7" CLEAR GLOBE
BA7F 7" FROSTED GLOBE
(100W INC MAX/LED25W)



PR8 8" PRISMATIC
PR8F 8" PRISMATIC FROSTED
(200W INC MAX/LED45W)



OC 8" OPAL TAPERED GLOBE
(60W INC MAX/LED25W)

J – ACCESSORIES

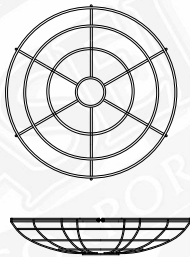

GR8 8" WIRE GRILL
GR12 12" WIRE GRILL
GR16 16" WIRE GRILL
GR18 18" WIRE GRILL
GR20 20" WIRE GRILL

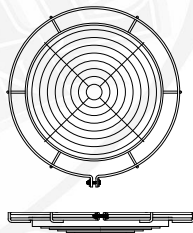

LGR8 8" LOUVERED GRILL
LGR12 12" LOUVERED GRILL
LGR16 16" LOUVERED GRILL
LGR18 18" LOUVERED GRILL
LGR20 20" LOUVERED GRILL

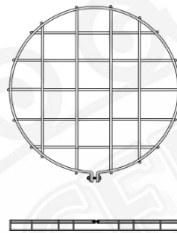

FGR8 8" FLAT GRILL
FGR12 12" FLAT GRILL
FGR16 16" FLAT GRILL
FGR18 18" FLAT GRILL
FGR20 20" FLAT GRILL



CRL8 8" CURVED POLYCARB LENS
CRL12 12" CURVED POLYCARB LENS
CRL16 16" CURVED POLYCARB LENS
CRL18 18" CURVED POLYCARB LENS
CRL20 20" CURVED POLYCARB LENS

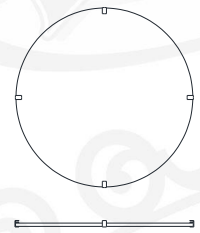

FLE8 8" FLAT CLEAR LENS
FLE12 12" FLAT CLEAR LENS
FLE16 16" FLAT CLEAR LENS
FLE18 18" FLAT CLEAR LENS
FLE20 20" FLAT CLEAR LENS

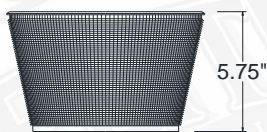

REF 9.5" DIAMETER REFRACTOR



UGR U-WIRE GUARD

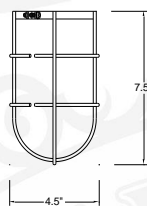

WG-1 WIRE GUARD

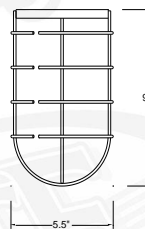

WG-2 WIRE GUARD

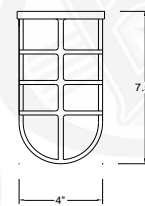

GU-1 CAST ALUMINUM GUARD

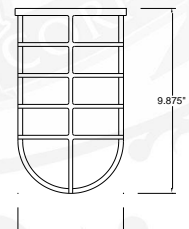

GU-2 CAST GUARD