



# BASELITE – PC – LED – SPECIFICATION SHEET



PROJECT NAME: \_\_\_\_\_ PROJECT TYPE: \_\_\_\_\_

MODEL #	/	/	/	/	/	/	/	/	/	X	/	/
	A	B	C	D	E	F	G	H	I	J	K	
EXAMPLE:	PHSA22	41	ST24	SLC1/2"	43	45W	3K	LDM120		GR13	44	

\*SKIP SECTION IF OPTION DOES NOT APPLY

NOTES:



## A - SHADES

**PC SERIES**  
**PC12** - 25WLED (MAX)  
**PC16** - 50WLED (MAX)  
**PC22** - 50WLED (MAX)

## B - FINISH OPTIONS

(SEE WEBSITE FOR SWATCH COLORS)  
 (\*SEE NOTES FOR LIMITATIONS\*)  
 21P, 41, 41.5, 43, 44, 48, 51, 52, 53, 58, 59,  
 61, 62, 74, 79, 97, 99, 100, MG.

## C - MOUNTING OPTIONS

**CORD MOUNT**  
**LBLC** - 8' black cord & canopy  
**LWHC** - 8' white cord & canopy  
**LTCB** - 8' black cord, loop, cable & canopy  
**LTCW** - 8' white cord, loop, cable & canopy  
**LTLB** - 8' black telephone cable  
**LTLW** - 8' white telephone cable  
**LCBLC** - 8' black cord, cable and canopy  
**LCWHC** - 8' white cord, cable and canopy  
**3LCBLC** - 3 cable and 8' black cord & canopy  
**3LCBLW** - 3 cable and 8' white cord & canopy  
**HKLBC** - hook and 8' black cord & canopy  
**HKLWC** - hook and 8' white cord & canopy

**STEM MOUNT**  
**ST18** - 18" stem  
**ST24** - 24" stem  
**ST36** - 36" stem  
**ST48** - 48" stem  
**STXX** - XX = stem length

## D - MOUNTING ADD-ONS

**LED ADD-ONS**  
**LSLC** - LED slope ceiling canopy  
**LSTC** - LED stem mount canopy  
**HB3** - ¾" hub

## E - MOUNTING COLOR

SEE SECTION "B" FOR COLOR OPTIONS.

## F - LIGHT SOURCE

(SEE PAGE 3 FOR WATTAGE LIMITATIONS)  
**LIGHT EMITTED DIODE (LED)**  
 10W, 12W, 25W, 35W, 50W

\*NOTE - MAX WATTAGE IS LISTED NEXT TO THE SHADE MODEL NUMBER IN SECTION "A". ALL WATTAGES BELOW THAT ARE ALSO AVAILABLE FOR THE SAME MODEL NUMBER.

## G - LED COLOR TEMP

27K - 2700 K  
 3K - 3000 K  
 35K - 3500 K  
 4K - 4000 K  
 5K - 5000 K

## H - ELECTRICAL OPTION

(SEE PAGE 3 FOR DIMMING OPTION SPECIFICATIONS)  
**LDM120**  
**LDM0-10**

## I - GLASS OPTIONS

NOT AVAILABLE

## J - ACCESSORIES

**LGR12** - 12" louvered grill  
**LGR16** - 16" louvered grill  
**LGR22** - 22" louvered grill  
**FLE12** - 12" flat clear lens w/ clips  
**FLE16** - 16" flat clear lens w/ clips  
**FLE22** - 22" flat clear lens w/ clips  
**BLE12** - 12" flat clear lens w/ band  
**BLE16** - 16" flat clear lens w/ band  
**BLE22** - 22" flat clear lens w/ band  
**LL12** - 12" clear conical lens  
**LL16** - 16" clear conical lens  
**LL22** - 22" clear conical lens  
**CRL12** - 12" clear curved lens  
**CRL16** - 16" clear curved lens  
**CRL22** - 22" clear curved lens  
**DRL16** - 16" clear drop lens  
**DRL22** - 22" clear drop lens  
**BRS16** - 16" aluminum bottom ring  
**BRS22** - 22" aluminum bottom ring  
**TRS16** - 16" aluminum top ring  
**TRS22** - 22" aluminum top ring  
**FWG16** - 16" full wire grill  
**FWG22** - 22" full wire grill

## K - ACCESSORY COLOR

SEE SECTION "B" FOR COLOR OPTIONS.

## NOTES

- (1). FINISH OPTIONS 20, 21, 22, 23 ARE FOR SOLID BRASS FIXTURES ONLY.
- (2). FINISH OPTIONS 19, 21, 22, 23, 75, 76, 77, 83, 84, 88, 93 AND 98 ARE APPLIED BY HAND. THESE FINISHES WILL VARY IN CONSISTENCY.
- (3). FINISH OPTIONS 19, 38, 39, 40, 49, 54, 57, 58, 61, 62, 63, 70, 71, 72, 73, 78, 83, 84, 88, 92, 93, 98 ONLY AVAILABLE INSIDE AND OUT OF FIXTURE. OTHER FINISHES ARE WHITE INSIDE.
- (4). FINISH OPTIONS 61, 62, 70, 71, 72, 73 ARE FINISHED WITH A SUPERCHROME ON THE INSIDE FOR ALL LED LIGHT SOURCE OPTIONS.  
 \*ACCORDING TO THE LIGHT SOURCE THE BACKPLATE MAY VARY IN SIZE.  
 (EXAMPLE: LED LIGHT SOURCE WILL HAVE A DEEPER BACKPLATE TO HOUSE THE DRIVER.)  
 \*ALL FIXTURES MOUNT TO A 4-0 JUNCTION BOX.  
 \*FIXTURE DIMENSIONS MAY VARY ± 0.25.

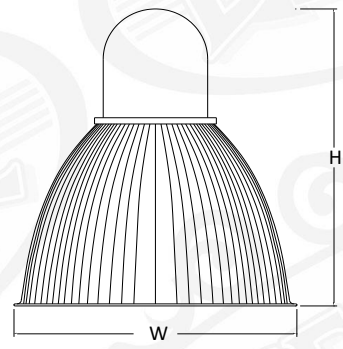

	HEIGHT	WIDTH
<b>PC12</b>	H-12.5"	W-12.5"
<b>PC16</b>	H-17.75"	W-16.25"
<b>PC22</b>	H-22"	W-22.5"



**C – MOUNTING OPTIONS**

**LED CORD MOUNTS**

\*FOR LED & COMPACT FLUORESCENT OPTIONS, CANOPIES WILL VARY IN SIZE DUE TO SIZE OF THE DRIVER/BALLAST THAT WILL BE LOCATED INSIDE OF THE CANOPY.  
\*CORDS RATED FOR DRY LOCATION \*CANOPY DIMENSIONS: 4" (H) 5.5" (W) \*CORD AND CANOPY COME IN THE SAME COLOR.



**LCBLC** 8' BLACK CORD, CABLE & CANOPY  
**LCWHC** 8' WHITE CORD, CABLE & CANOPY



**LTLB** 2.5' BLACK TELEPHONE CABLE & CANOPY  
**LTLW** 2.5' WHITE TELEPHONE CABLE & CANOPY



**LTCB** 8' CABLE, BLACK CORD, LOOP & CANOPY  
**LTCW** 8' CABLE, WHITE CORD, LOOP & CANOPY



**LBLC** 8' BLACK CORD AND CANOPY  
**LWHC** 8' WHITE CORD AND CANOPY

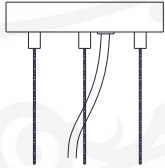

**3LCBLC** 3 CABLE, BLACK CORD & CANOPY  
**3LCWHC** 3 CABLE, WHITE CORD & CANOPY



**HKLBC** 3/4" HOOK WITH 8' BLACK CORD & CANOPY  
**HKLWC** 3/4" HOOK WITH 8' WHITE CORD & CANOPY

**STEM MOUNTS**

\*STEMS ARE RATED FOR DAMP LOCATION



STEM- 1/2" NPT  
**ST(XX)** STEM- 3/4" NPT  
XX = LENGTH OF STEM  
(EXAMPLE – "ST18" = STEM MOUNT 18" LENGTH)  
\*CANOPY NOT INCLUDED, ADD IN SECTION D

**D - MOUNTING ADD-ONS**

**LED MOUNTING ADD-ONS**

\* FOR LED & COMPACT FLUORESCENT OPTIONS, CANOPIES WILL VARY IN SIZE DUE TO SIZE OF THE DRIVER/BALLAST THAT WILL BE LOCATED INSIDE OF THE CANOPY.

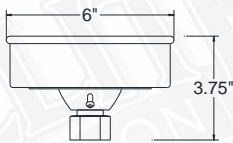

**LSLC** LED SLOPE CEILING CANOPY  
\*(Slopes To 20 Degrees)

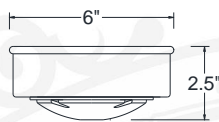

**LSTC** LED STEM MOUNT CANOPY



**HB3 - 3/8" HUB**



**F – LIGHT SOURCE**

BASELITE'S PUBLISHED LUMINAIRE PHOTOMETRIC TESTING WAS PERFORMED IN A 3-METER INTEGRATING SPHERE USING THE 4TT GEOMETRY METHOD. DATA IS CONSIDERED TO BE REPRESENTATIVE OF THE CONFIGURATIONS SHOWN, WITHIN THE TOLERANCES ALLOWED BY LIGHTING FACTS. TO OBTAIN AN IES FILE SPECIFIC TO YOUR PROJECT, PLEASE CONTACT THE FACTORY.

**LIGHT EMITTING DIODE (LED)**

**LED 25W (MAX)** - PC12  
**LED 50W (MAX)** - PC16, PC22

**\*IMPORTANT** – FOR LIGHT EMITTED DIODE (LED) LIGHT SOURCE OPTION, FIXTURES ARE LIMITED DUE TO SIZE OF THE FIXTURE AND THE CORD WATTAGE RESTRICTIONS. PLEASE SEE MAX WATTAGE AVAILABILITY. **EXAMPLE:** /LED50W /

OPTION	WATTAGE	LUMENS	CRI	VOLTAGE	DIMMING
LED10W	10W	1570	>90	120-277 VAC	See section "H"
LED12W	12W	1596	>90	120-277 VAC	See section "H"
LED25W	25W	3125	>90	120-277 VAC	See section "H"
LED35W	35W	4200	>90	120-277 VAC	See section "H"
LED50W	50W	5750	>90	120-277 VAC	See section "H"

@3500K

**H – ELECTRICAL OPTION**

MOST BASELITE'S ELECTRICAL OPTIONS ARE ONLY COMPATIBLE FOR CERTAIN FIXTURES. PLEASE SEE NOTES BELOW AND FOR FURTHER DETAILS CONTACT THE FACTORY. FOR DIMMING BALLAST OPTION, PLEASE CHOOSE MARK X OR MARK VII, SO RESTRICTIONS APPLY DUE TO THE SIZE OF THE BALLAST AND FIXTURE.

**LED DIMMING OPTIONS**

FOR TRIAC OR 0-10V OPTOIN CHOOSE FROM THE FOLLOWING. CONTACT DRIVER MANUFACTURER FOR SPECIFICATIONS.

- LDM120** - TRIAC DIMMING AT 120 VOLT
- LDM0-10V** - 0 – 10v

**J – ACCESSORIES**

\*NOTE: MUST USE TEMPERED GLASS FOR LIGHT FIXTURES USING HIGH INTENSITY DISCHARGE (HID) LIGHT SOURCE OPTION.

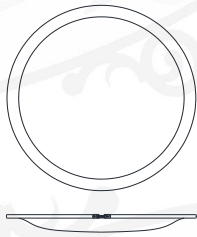

- CRL12** - 12" CLEAR CURVED LENS
- CRL16** - 16" CLEAR CURVED LENS
- CRL22** - 22" CLEAR CURVED LENS

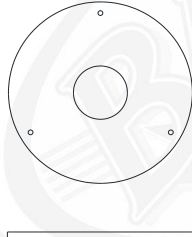

- ARFL12** - 12" FLAT CLEAR LENS WITH CLIPS
- ARFL16** - 16" FLAT CLEAR LENS WITH CLIPS
- ARFL22** - 22" FLAT CLEAR LENS WITH CLIPS

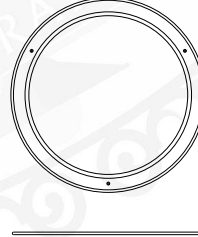

- ARFR12** - 12" FALT METAL RING
- ARFR16** - 16" FLAT METAL RING
- ARFR22** - 22" FLAT METAL RING

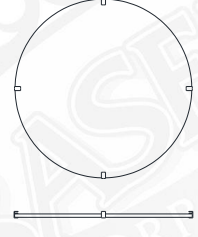

- FLE12** - 12" FLAT CLEAR LENS WITH CLIPS
- FLE16** - 16" FLAT CLEAR LENS WITH CLIPS
- FLE22** - 22" FLAT CLEAR LENS WITH CLIPS



**J – ACCESSORIES (CONT'D)**

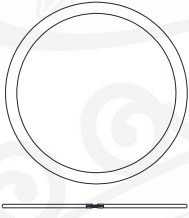

**BLE12** 12" FLAT CLEAR LENS WITH BAND  
**BLE16** 16" FLAT CLEAR LENS WITH BAND  
**BLE22** 22" FLAT CLEAR LENS WITH BAND

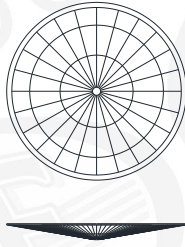

**LL12** 12" CLEAR CONICAL LENS  
**LL16** 16" CLEAR CONICAL LENS  
**LL22** 22" CLEAR CONICAL LENS

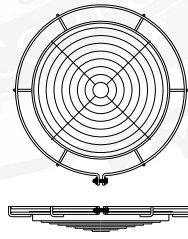

**LGR12** 12" LOUVERED GRILL  
**LGR16** 16" LOUVERED GRILL  
**LGR22** 22" LOUVERED GRILL

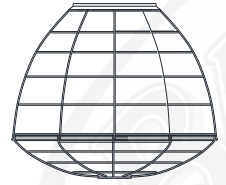

**FWG16** - 16" FULL WIRE GRILL  
**FWG22** - 22" FULL WIRE GRILL

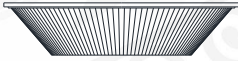

**DRL16** - 16" PRISMATIC DROP LENS  
**DRL22** - 22" PRISMATIC DROP LENS



**TRS16** - 16" TOP RING ALUMINUM SHIELD  
**TRS22** - 22" TOP RING ALUMINUM SHIELD



**BRS16** - 16" BOTTOM RING ALUMINUM SHIELD  
**BRS22** - 22" BOTTOM RING ALUMINUM SHIELD