



# BASELITE – MODERN PENDANTS – LED – SPEC SHEET



PROJECT NAME: \_\_\_\_\_ PROJECT TYPE: \_\_\_\_\_

| MODEL #  | /   | /        | /   | /   | /  | /      | X | / | X | / | X | / | X | / | X |
|----------|-----|----------|-----|-----|----|--------|---|---|---|---|---|---|---|---|---|
|          | A   | B        | C   | D   | E  | F      | G | H | I | J | K |   |   |   |   |
| EXAMPLE: | 3TD | 80-59-81 | BLC | CNK | 41 | 150INC |   |   |   |   |   |   |   |   |   |

\*SKIP SECTION IF OPTION DOES NOT APPLY

NOTES:

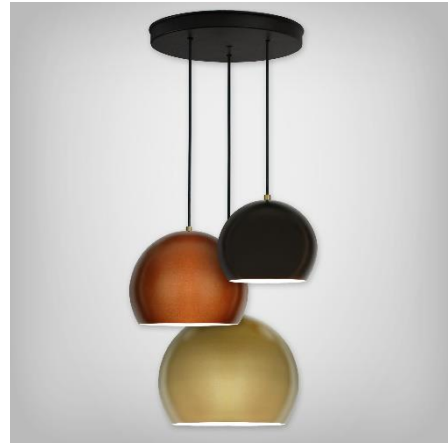

## A - SHADES

### MODERN PENDANTS

- 3TD - 25WLED (MAX)
- 3PEH - 25WLED (MAX)
- 3PE - 25WLED (MAX)
- PEA - 25WLED (MAX)
- PEB - 25WLED (MAX)
- PEC - 25WLED (MAX)
- PED - 25WLED (MAX)
- PEF - 25WLED (MAX)
- PEG - 25WLED (MAX)
- PEH - 25WLED (MAX)
- PEI - 25WLED (MAX)
- PEJ - 25WLED (MAX)
- PEK - 25WLED (MAX)
- PEO - 25WLED (MAX)
- PEOB - 25WLED (MAX)
- PEP - 25WLED (MAX)
- PEQ - 25WLED (MAX)
- PER - 25WLED (MAX)
- PES - 25WLED (MAX)
- PET - 25WLED (MAX)
- PEU - 25WLED (MAX)
- PEV - 25WLED (MAX)
- PEY - 25WLED (MAX)
- PEX - 25WLED (MAX)
- PEZ - 25WLED (MAX)
- DMD10 - 25WLED (MAX)
- SQB618 - 25WLED (MAX)
- S1 - N/A (LED LAMP ONLY)
- TD8 - 25WLED (MAX)
- TD10 - 25WLED (MAX)
- TD12 - 25WLED (MAX)
- PEHD615 - 25WLED (MAX)
- MPA - 25WLED (MAX)

## B - FINISH OPTIONS

(SEE WEBSITE FOR SWATCH COLORS)  
 (\*SEE NOTES FOR LIMITATIONS\*)  
 14, 15, 16, 17, 18, 19, 19P, 20, 20P, 20PB,  
 20SB, 21, 21P, 22, 22P, 23, 23P, 38, 39, 40,  
 41, 41.5, 42, 43, 44, 45, 46, 48, 49, 50, 51,  
 52, 53, 54, 55, 57, 58, 59, 60, 61, 62, 63, 64,  
 65, 66, 70, 71, 72, 73, 74, 75, 76, 77, 78, 79,  
 80, 81, 82, 83, 84, 85, 86, 87, 88, 89, 90, 91,  
 92, 93, 94, 95, 96, 97, 98, 99, 100, MG.

## C – MOUNTING OPTIONS

**LED CORD MOUNT**  
 LBLC, LWHC, LTCB, LTCW, LTCHB, LTCHW,  
 LTLB, LTLW, LTLB, LTLW, LRCB, LRCW,  
 LRCHB, LRCHW, LFHB, LFHW, LHBLC,  
 LHWHC, LCBLC, LCWHC, LCHB, LCHW  
**STEM MOUNT (INC)**  
 ST6, ST12, ST18, ST24, ST36, ST48, STXX

## D – MOUNTING ADD-ONS

**INC ADD-ONS**  
 CNK – MULTIPLE FIXTURE CANOPY  
 STC – STEM MOUNT CANOPY  
 SLC1/2" – SLOPE CEILING CANOPY 1/2"

## E – MOUNTING COLOR

SEE SECTION "B" FOR COLOR OPTIONS.

## F – LIGHT SOURCE

(SEE PAGE 3 FOR WATTAGE LIMITATIONS)  
**LIGHT EMITTED DIODE (LED)**  
 10W, 12W, 25W  
  
 \*NOTE – MAX WATTAGE IS LISTED NEXT TO THE  
 SHADE MODEL NUMBER IN SECTION "A". ALL  
 WATTAGES BELOW THAT ARE ALSO AVAILABLE FOR  
 THE SAME MODEL NUMBER.

## G – LED COLOR TEMP

- 27K – 2700 K
- 3K – 3000 K
- 35K – 3500 K
- 4K – 4000 K
- 5K – 5000 K

## H – ELECTRICAL OPTION

(SEE PAGE 3 FOR DIMMING OPTION  
 SPECIFICATIONS)  
**LDM120**  
**LDM0-10**

## I – GLASS OPTIONS

CALL FACTORY FOR REQUEST.

## J – ACCESSORIES

CALL FACTORY FOR REQUEST.

## K – ACCESSORY COLOR

SEE SECTION "B" FOR COLOR  
 OPTIONS.

## NOTES

- (1). FINISH OPTIONS 20, 21, 22, 23 ARE FOR SOLID BRASS FIXTURES ONLY.
- (2). FINISH OPTIONS 19, 21, 22, 23, 75,76, 77, 83, 84, 88, 93 AND 98 ARE APPLIED BY HAND. THESE FINISHES WILL VARY IN CONSISTENCY.
- (3). FINISH OPTIONS FOR SHADES ≤ 10" IN DIAMETER ARE THE SAME INSIDE AND OUT OF FIXTURE. SHADES > 10" IN DIAMETER ARE WHITE ON THE INSIDE.
- (4). FINISH OPTIONS 19, 38, 39, 40, 49, 54, 57, 58, 61, 62, 63, 70, 71, 72, 73, 78, 83, 84, 88, 92, 93, 98 ONLY AVAILABLE INSIDE AND OUT OF FIXTURE. OTHER FINISHES ARE WHITE INSIDE.
- (5). FINISH OPTIONS 61, 62, 70, 71, 72, 73 ARE FINISHED WITH A SUPERCHROME ON THE INSIDE FOR ALL LED LIGHT SOURCE OPTIONS.
- (6). COLOR CORDS ARE NOT APPLICABLE FOR LED OPTIONS.  
 \*ALL FIXTURES MOUNT TO A 4-O JUNCTION BOX.  
 \*FIXTURE DIMENSIONS MAY VARY ± 0.25.

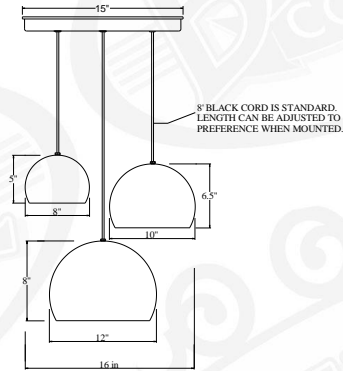

**3TD H-TBD W-16"**

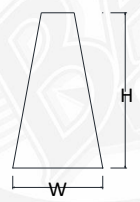

**PEA H-15" W-8.75"**

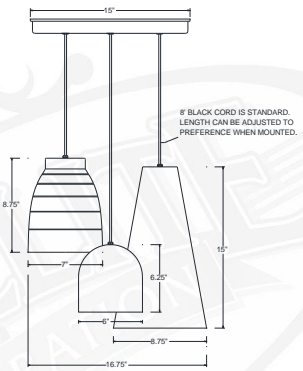

**3PE H-TBD W-16.75"**

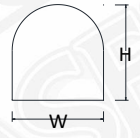

**PEB H-6.25" W-6"**

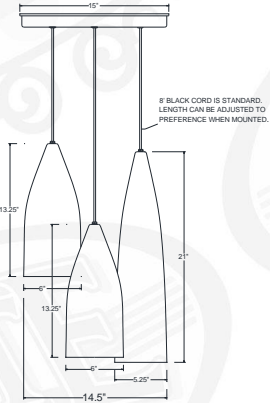

**3PEH H-TBD W-14.5"**

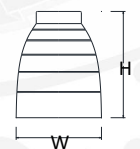

**PEC H-8.75" W-7"**



**A - SHADES**



**PED** H-11" W-4.5"

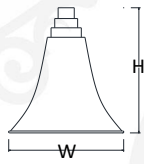

**PEF** H-13" W-12"

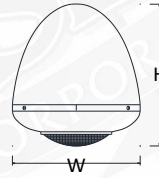

**PEG** H-11" W-10"

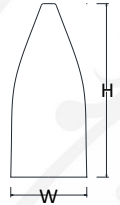

**PEH** H-13.25" W-6"

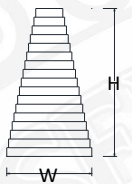

**PEJ** H-10" W-5.75"



**PEOB** H-12" W-7"



**PEP** H-15" W-18"



**PEI** H-21" W-5.25"

**PEK** H-7.5" W-5"

**PEQ** H-13.5" W-16"

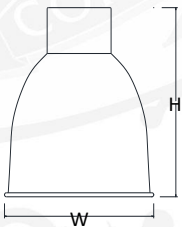

**PEO** H-16.5" W-14"

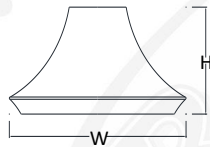

**PES** H-11.75" W-22.5"

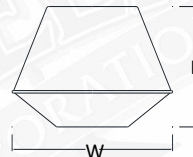

**PET** H-12" W-18"

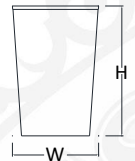

**PEU** H-9.5" W-14.25"

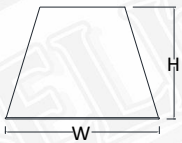

**PER** H-10.5" W-14.5"



**PEX** H-11" W-12"

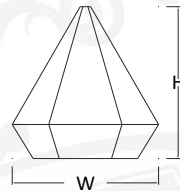

**DMD10** H-14.5" W-14"



**SQB618** H-18" W-6"

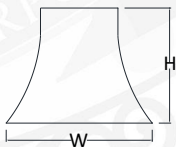

**PEV** H-16.5" W-13"

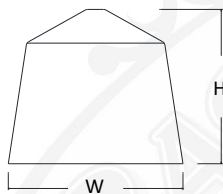

**PEY** H-16.75" W-19"

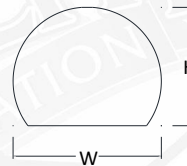

**TD8** H-6.625" W-8"

**TD10** H-8" W-10"

**TD12** H-9.375" W-12"

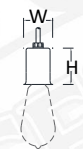

**S1** H-2.625" W-2"



**MPA** H-14" W-5.5"

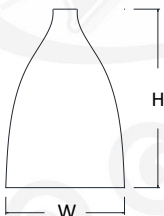

**PEZ** H-14.5" W-9.75"



**C - MOUNTING OPTIONS**

**STEM MOUNT**

\*STEMS RATED FOR DAMP LOCATION \* 1/4" NPT AND 3/4" NPT AVAILABLE UPON REQUEST



**ST(XX)** STEM- 1/2"

XX = LENGTH OF STEM  
(EXAMPLE - "ST18" = STEM MOUNT 18" LENGTH)  
\*CANOPY NOT INCLUDED, ADD IN SECTION D

**D - MOUNTING ADD-ONS**

**MOUNTING ADD-ON**



**CNK** CANOPY For MULTIPLE FIXTURES

\*CNK dimensions vary on number of fixtures applied

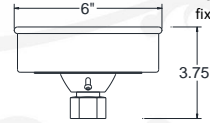

**LSLC 1/2"** SLOPE CEILING CANOPY 1/2"

\*(Slopes To 20 Degrees)

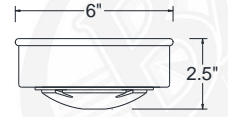

**LSTC 1/2"** 1/2" STEM MOUNT CANOPY

**LED CORD MOUNTS**

FOR LED & COMPACT FLUORESCENT OPTIONS, CANOPIES WILL VARY IN SIZE DUE TO SIZE OF THE DRIVER/BALLAST THAT WILL BE LOCATED INSIDE OF THE CANOPY. \*CORDS RATED FOR DRY LOCATION  
\*CANOPY DIMENSIONS: 4" (H) 5.5" (W)



**LBLC** 8' BLACK CORD  
**LWHC** 8' WHITE CORD

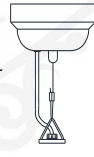

**LTCB** 8' BLACK CORD, CABLE, and LOOP  
**LTCW** 8' WHITE CORD, CABLE, and LOOP



**LTCHB** 8' BLACK CORD, 3' CHAIN, and LOOP  
**LTCHW** 8' WHITE CORD, 3' CHAIN, and LOOP



**LTLB** 8' BLACK TELEPHONE CORD AND CABLE  
**LTLW** 8' WHITE TELEPHONE CORD AND CABLE  
\* Not available with compact fluorescent



**LRCB** 8' BLACK CORD, CABLE, and LOOP  
**LRCW** 8' WHITE CORD, CABLE, and LOOP



**LRCHB** 8' BLACK CORD, 3' CHAIN, and LOOP  
**LRCHW** 8' WHITE CORD, 3' CHAIN, and LOOP



**LFHB** 8' BLACK CORD WITH FLAT HUB  
**LFWH** 8' WHITE CORD WITH FLAT HUB



**LCBLC** 8' BLACK CORD and CABLE  
**LCWHC** 8' WHITE CORD and CABLE



**LCHB** 8' BLACK CORD, 3' CHAIN, and LOOP  
**LCHW** 8' WHITE CORD, 3' CHAIN, and LOOP  
\* Loop may vary due to shade style

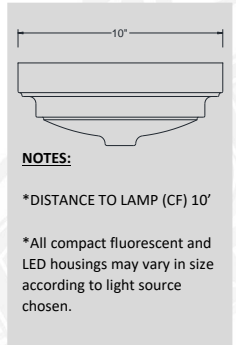

**NOTES:**

\*DISTANCE TO LAMP (CF) 10"

\*All compact fluorescent and LED housings may vary in size according to light source chosen.

**F – LIGHT SOURCE**

BASELITE'S PUBLISHED LUMINAIRE PHOTOMETRIC TESTING WAS PERFORMED IN A 3-METER INTEGRATING SPHERE USING THE 4TT GEOMETRY METHOD. DATA IS CONSIDERED TO BE REPRESENTATIVE OF THE CONFIGURATIONS SHOWN, WITHIN THE TOLERANCES ALLOWED BY LIGHTING FACTS. TO OBTAIN AN IES FILE SPECIFIC TO YOUR PROJECT, PLEASE CONTACT THE FACTORY.

**LIGHT EMITTING DIODE (LED)**

**LED 25W (MAX)** - 3TD, 3PEH, 3PE, PELB, PEMB, PENB, S1, TD8, TD10, TD12, PEA, PEB, PEC, PED, PEF, PEG, PEH, PEI, PEJ, PEK, PEO, PEP, PEQ, PER, PES, PET, PEU, PEV, PEX, PEY, PEZ, DMD10, SQB618, WRO, WRO1, WRO2, PEHD615, MPA

**\*IMPORTANT** – FOR LIGHT EMITTED DIODE (LED) LIGHT SOURCE OPTION, FIXTURES ARE LIMITED DUE TO SIZE OF THE FIXTURE AND THE CORD WATTAGE RESTRICTIONS. PLEASE SEE MAX WATTAGE AVAILABILITY. **EXAMPLE: / LED25W /**

| OPTION | WATTAGE | LUMENS | CRI | VOLTAGE     | DIMMING         |
|--------|---------|--------|-----|-------------|-----------------|
| LED10W | 10W     | 1280   | >90 | 120-277 VAC | See section "H" |
| LED12W | 12W     | 1481   | >90 | 120-277 VAC | See section "H" |
| LED25W | 25W     | 2812   | >90 | 120-277 VAC | See section "H" |

@3500K

**H – ELECTRICAL OPTION**

MOST BASELITE'S ELECTRICAL OPTIONS ARE ONLY COMPATIBLE FOR CERTAIN FIXTURES. PLEASE SEE NOTES BELOW AND FOR FURTHER DETAILS CONTACT THE FACTORY. FOR DIMMING BALLAST OPTION, PLEASE CHOOSE MARK X OR MARK VII, SO RESTRICTIONS APPLY DUE TO THE SIZE OF THE BALLAST AND FIXTURE.

**LED DIMMING OPTIONS**

FOR TRIAC OR 0-10V OPTOIN CHOOSE FROM THE FOLLOWING. CONTACT DRIVER MANUFACTURER FOR SPECIFICATIONS.

**LDM120** - TRIAC DIMMING AT 120 VOLT

**LDM0-10V** - 0 – 10v