



BASELITE – GENEVA – LED – SPECIFICATION SHEET



PROJECT NAME: _____ PROJECT TYPE: _____

| MODEL # | / | / | / | / | / | / | / | X | / | X | / | X | / | X |
|----------|------|----|-----|-----|----|----|-----|---|---|---|---|---|---|---|
| EXAMPLE: | LGB1 | 41 | BLC | CNK | 41 | 4W | 22K | | | | | | | |

*SKIP SECTION IF OPTION DOES NOT APPLY

NOTES:



A - SHADES

GENEVA COLLECTION

- LGB1 – 4WLED (MAX)
- LGB2 – 4WLED (MAX)
- LGB3 – 4WLED (MAX)
- LGB4 – 4WLED (MAX)
- LGB5 – 4WLED (MAX)
- LGB6 – 4WLED (MAX)
- LGB7 – 4WLED (MAX)
- LGB8 – 4WLED (MAX)
- LGB9 – 4WLED (MAX)

B - FINISH OPTIONS

(SEE WEBSITE FOR SWATCH COLORS)
 (*SEE NOTES FOR LIMITATIONS*)
 14, 15, 16, 17, 18, 19, 19P, 20, 20P, 20PB,
 20SB, 21, 21P, 22, 22P, 23, 23P, 38, 39, 40,
 41, 41.5, 42, 43, 44, 45, 46, 48, 49, 50, 51,
 52, 53, 54, 55, 57, 58, 59, 60, 61, 62, 63, 64,
 65, 66, 70, 71, 72, 73, 74, 75, 76, 77, 78, 79,
 80, 81, 82, 83, 84, 85, 86, 87, 88, 89, 90, 91,
 92, 93, 94, 95, 96, 97, 98, 99, 100, MG.

C - MOUNTING

- WALL MOUNT**
 WM19, WM20, WM21, W23,
 WM24, WM25, WM26, WM29,
 WM29V
- CORD MOUNT (INC)**
 BLC, WHC, TCB, TCW, FHB, FHW
- COLOR CORD CODES**
 (SEE WEBSITE FOR SWATCH COLORS)
 BKCC, WCC, RCC, BCC, OCC, PCC,
 BHCC, BLCC, PCCC, TSCC, NTCC,
 MCC, NCC, SCC, TCC, NYCC, BZCC
- STEM MOUNT**
 ST6, ST12, ST18, ST24, ST36, ST48, STXX

D – MOUNTING ADD-ONS

UNIVERSAL ADD-ONS
 CNK

E – ACC. FINISH OPTION

SEE SECTION “B” FOR COLOR OPTION.

F – LIGHT SOURCE

LIGHT EMITTED DIODE (LED)
 4W

G – LED COLOR TEMP

(ONLY APPLICABLE FOR LED LIGHT SOURCE. SKIP THIS SECTION IF OPTION DOES NOT APPLY.)
 22K – 2200 K*

NOTES

- *FINISH OPTIONS 20, 21, 22, 23 ARE FOR SOLID BRASS FIXTURES ONLY
- *FINISH OPTIONS 19, 21, 22, 23 ARE AN ACID FINISH AND IS APPLIED BY HAND. THESE FINISHES WILL VARY IN CONSISTENCY.
- *FINISH OPTIONS 61, 62, 70, 71, 72, 73 ARE FINISHED WITH A SUPERCHROME ON THE INSIDE FOR ALL LED LIGHT SOURCE OPTIONS.
- *FIXTURE DIMENSIONS MAY VARY ± 0.25

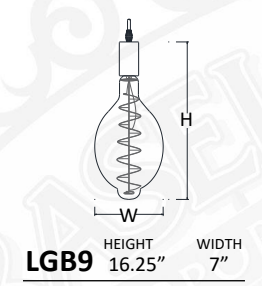
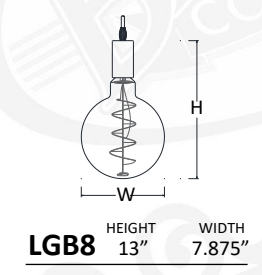
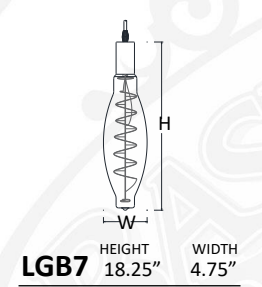
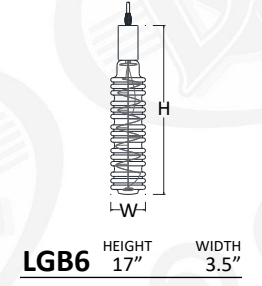
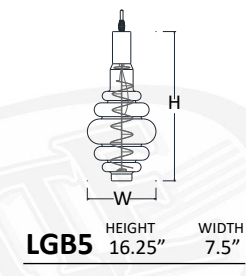
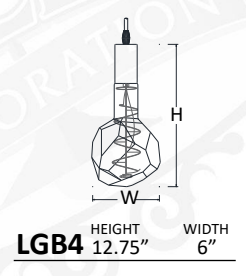
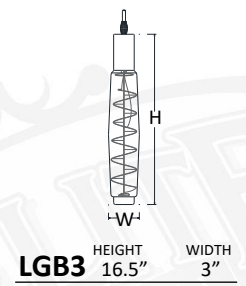
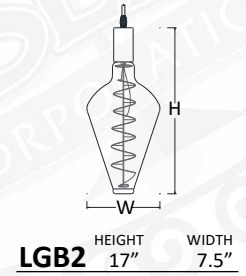
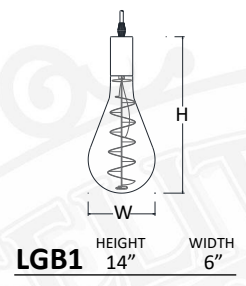



C - MOUNTING OPTIONS (CONTINUED)

WALL MOUNT

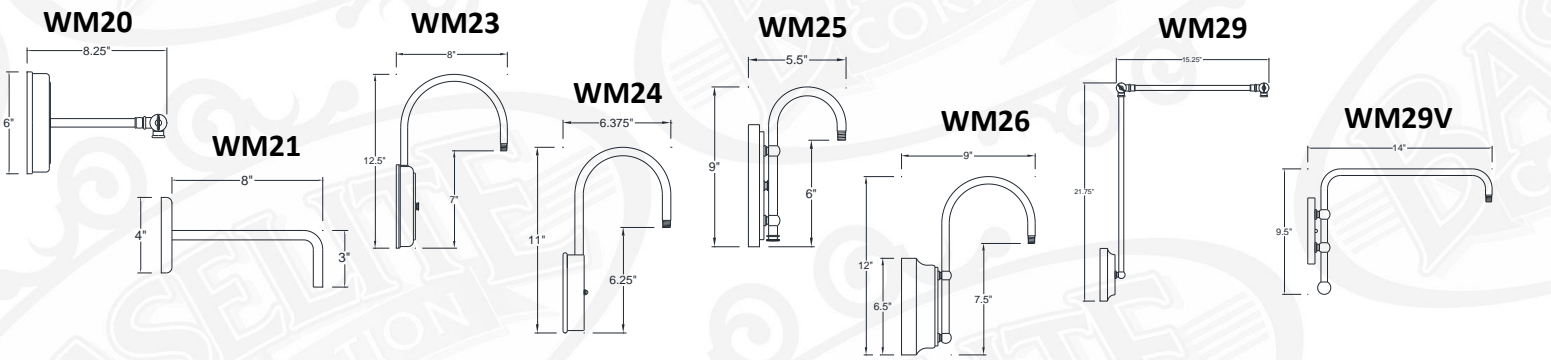

COLOR CORD CODES

*COLOR CORDS NOT APPLICABLE FOR LED. MEDIUM BASE LED BULBS ARE APPLICABLE.



BKCC BLACK CLOTH CORD



MCC MINT CLOTH CORD



BHCC BLACK WHITE HOUNDSTOOTH CLOTH CORD



WCC WHITE CLOTH CORD



NCC NATURAL CLOTH CORD



BLCC BLACK LINEN CLOTH CORD



RCC RED CLOTH CORD



SCC SILVER CLOTH CORD



PCC PINK CRISS CROSS CLOTH CORD



BCC BLUE CLOTH CORD



TCC TURQUOISE CLOTH CORD



TSCC TURQUOISE BROWN STRIPE CLOTH CORD



OCC ORANGE CLOTH CORD



NYCC NEON YELLOW CLOTH CORD



NTCC NATURAL TWEED CLOTH CORD



PCC PURPLE CLOTH CORD



BZCC BLACK WHITE ZIG ZAG CLOTH CORD

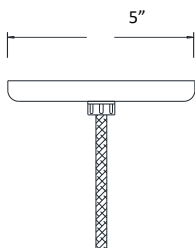

* CANOPY INCLUDED WITH ANY CHOICE OF COLOR CORD.
* DESIGNED FOR INDOOR USE OR DRY LOCATIONS
* 100W MAX/300V RATED





C - MOUNTING OPTIONS (CONTINUED)

CORD MOUNTS

FOR LED OPTIONS, CANOPIES WILL VARY IN SIZE DUE TO SIZE OF THE DRIVER/BALLAST THAT WILL BE LOCATED INSIDE OF THE CANOPY.



BLC 8' BLACK CORD (INCLUDES CANOPY) INC
WHC 8' WHITE CORD (INCLUDES CANOPY) INC

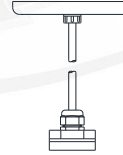

FHB 8' BLACK CORD WITH FLAT HUB
FHW 8' WHITE CORD WITH FLAT HUB

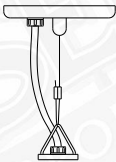

TCB 8' BLACK CORD, CABLE, and LOOP
TCW 8' WHITE CORD, CABLE, and LOOP

STEM MOUNT



ST(XX) STEM- 1/4" NPT

XX = LENGTH OF STEM
(EXAMPLE - "ST18" = STEM MOUNT 18" LENGTH)
*CANOPY NOT INCLUDED, ADD IN SECTION D

D - UNIVERSAL ADD-ON



CNK Canopy For Multiple Fixtures

*CNK dimensions vary on number of fixtures are applied

F - LIGHT SOURCE

BASELITE'S PUBLISHED LUMINAIRE PHOTOMETRIC TESTING WAS PERFORMED IN A 3-METER INTEGRATING SPHERE USING THE 4TT GEOMETRY METHOD. DATA IS CONSIDERED TO BE REPRESENTATIVE OF THE CONFIGURATIONS SHOWN, WITHIN THE TOLERANCES ALLOWED BY LIGHTING FACTS. TO OBTAIN AN IES FILE SPECIFIC TO YOUR PROJECT, PLEASE CONTACT THE FACTORY.

| OPTION | WATTAGE | LUMEN | CRI | VOLTAGE | DIMMING |
|--|---------|---------------|--|-------------|---------|
| MEDIUM BASE E26 (LED BULB) | | | | | |
| LED4W | 4W | 200 @2200K | >95 | 120-277 VAC | N/A |
| <p>*IMPORTANT - FOR LIGHT EMITTED DIODE (LED) LIGHT SOURCE OPTION FIXTURES ARE LIMITED DUE TO SIZE OF THE FIXTURE AND THE CORD WATTAGE RESTRICTIONS. PLEASE SEE AVAILABILITY CHART TO THE RIGHT.</p> <p>EXAMPLE: / LED4W /</p> | | | <p>LED 4W (MAX)- LGB1, LGB2, LGB3, LGB4, LGB5, LGB6, LGB7, LGB8, LGB9</p> | | |