



# BASELITE – OVERSIZED PENDANTS – LED – SPEC SHEET



PROJECT NAME: \_\_\_\_\_ PROJECT TYPE: \_\_\_\_\_

MODEL #	/	/	/	/	/	/	/	X	/	X	/	X	/	X	/	X
EXAMPLE:	A	B	C	D	E	F	G	H	I	J	K					
	3TD	80-59-81	BLC	CNK	41	150INC										

NOTES:



## A - SHADES

### OVERSIZED PENDANTS

- LCN30 - 100WLED (MAX)
- ODB25 - 100WLED (MAX)
- MN27 - 100WLED (MAX)
- PEC18 - 100WLED (MAX)
- PEY - 100WLED (MAX)
- MW529 - 100WLED (MAX)

## B - FINISH OPTIONS

(SEE WEBSITE FOR SWATCH COLORS)  
 (\*SEE NOTES FOR LIMITATIONS\*)  
 14, 15, 16, 17, 18, 19, 19P, 20, 20P,  
 20PB, 20SB, 21, 21P, 22, 22P, 23, 23P,  
 38, 39, 40, 41, 41.5, 42, 43, 44, 45, 46,  
 48, 49, 50, 51, 52, 53, 54, 55, 57, 58, 59,  
 60, 61, 62, 63, 64, 65, 66, 70, 71, 72, 73,  
 74, 75, 76, 77, 78, 79, 80, 81, 82, 83, 84,  
 85, 86, 87, 88, 89, 90, 91, 92, 93, 94, 95,  
 96, 97, 98, 99, 100, MG.

## C – MOUNTING OPTIONS

- LED CORD MOUNT**  
LCBLC, LCWHC
- STEM MOUNT**  
ST6, ST12, ST18, ST24, ST36, ST48, STXX

## D – MOUNTING ADD-ONS

- LED ADD-ONS**  
LSTC ½" – LED STEM MOUNT CANOPY  
LSLC ½" – LED SLOPE CEILING CANOPY

## E – MOUNTING COLOR

SEE SECTION "B" FOR COLOR OPTIONS.

## F – LIGHT SOURCE

(SEE PAGE 2 FOR WATTAGE LIMITATIONS)  
**LIGHT EMITTED DIODE (LED)**  
 10W, 12W, 25W, 35W, 50W, 80W, 100W

\*NOTE – MAX WATTAGE IS LISTED NEXT TO THE SHADE MODEL NUMBER IN SECTION "A". ALL WATTAGES BELOW THAT ARE ALSO AVAILBLE FOR THE SAME MODEL NUMBER.

## G – LED COLOR TEMP

- 27K – 2700 K
- 3K – 3000 K
- 35K – 3500 K
- 4K – 4000 K
- 5K – 5000 K

## H – ELECTRICAL OPTION

(SEE PAGE 3 FOR DIMMING OPTION SPECIFICATIONS)

- LDM120
- LDM277
- LDM0-10

## I – GLASS OPTIONS

N/A

## J – ACCESSORIES

- CRL18, CRL19, CRL25, CRL27, CRL29, CRL30, FLE18, FLE19, FLE25, FLE27, FLE29, FLE30, GR30, BLE30

## K – ACCESSORY COLOR

SEE SECTION "B" FOR COLOR OPTIONS.

## NOTES

- (1). FINISH OPTIONS 20, 21, 22, 23 ARE FOR SOLID BRASS FIXTURES ONLY.
  - (2). FINISH OPTIONS 19, 21, 22, 23, 75, 76, 77, 83, 84, 88, 93 AND 98 ARE APPLIED BY HAND. THESE FINISHES WILL VARY IN CONSISTENCY.
  - (3). FINISH OPTIONS FOR SHADES ≤ 10" IN DIAMETER ARE THE SAME INSIDE AND OUT OF FIXTURE. SHADES > 10" IN DIAMETER ARE WHITE ON THE INSIDE.
  - (4). FINISH OPTIONS 19, 38, 39, 40, 49, 54, 57, 58, 61, 62, 63, 70, 71, 72, 73, 78, 83, 84, 88, 92, 93, 98 ONLY AVAILABLE INSIDE AND OUT OF FIXTURE. OTHER FINISHES ARE WHITE INSIDE.
  - (5). FINISH OPTIONS 61, 62, 70, 71, 72, 73 ARE FINISHED WITH A SUPERCHROME ON THE INSIDE FOR ALL LED LIGHT SOURCE OPTIONS.
- (5). COLOR CORDS ARE NOT APPLICABLE FOR LED OPTIONS.  
 \*ALL FIXTURES MOUNT TO A 4-O JUNCTION BOX.  
 \*FIXTURE DIMENSIONS MAY VARY ±0.25.

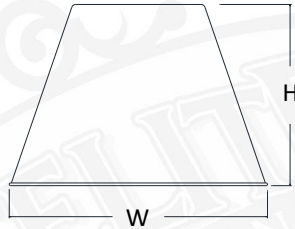

**LCN30** H-21" W-30"

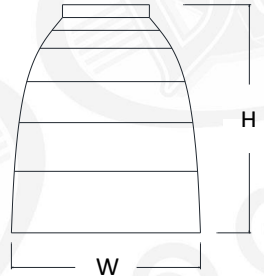

**PEC18** H-22" W-18.5"

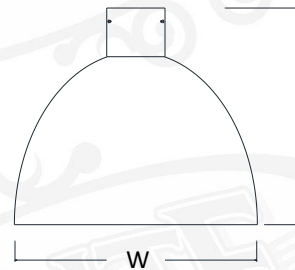

**ODB25** H-22.25" W-25"

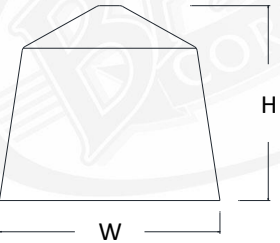

**PEY** H-16.75" W-19"

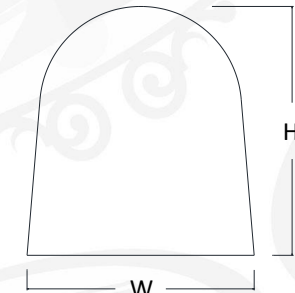

**MN27** H-29.5" W-27"

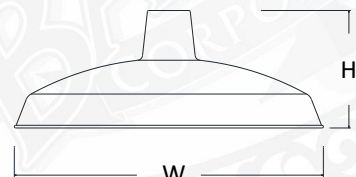

**MW529** H-11" W-29"



**C - MOUNTING OPTIONS**

**STEM MOUNT**

\*STEMS RATED FOR DAMP LOCATION \* 1/4" NPT AND 3/4" NPT AVAILABLE UPON REQUEST



**ST(XX)** STEM- 1/2" NPT

XX = LENGTH OF STEM  
(EXAMPLE – "ST18" = STEM MOUNT 18" LENGTH)  
\*CANOPY NOT INCLUDED, ADD IN SECTION D

**LED CORD MOUNTS**

\*FOR LED & COMPACT FLUORESCENT OPTIONS, CANOPIES WILL VARY IN SIZE DUE TO SIZE OF THE DRIVER/BALLAST THAT WILL BE LOCATED INSIDE OF THE CANOPY.  
\*CORDS RATED FOR DRY LOCATION \*CANOPY DIMENSIONS: 4" (H) 5.5" (W) \*CORD AND CANOPY COME IN THE SAME COLOR.

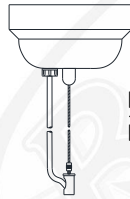

**LCBLC** 8' BLACK CORD and CABLE  
**LCWHC** 8' WHITE CORD and CABLE

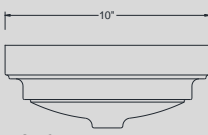

**NOTES:**

\*DISTANCE TO LAMP (CF) 10"

\*All compact fluorescent and LED housings may vary in size according to light source chosen.

**D - MOUNTING ADD-ONS**

**LED - STEM AND ARM ADD-ONS**

\* FOR LED & COMPACT FLUORESCENT OPTIONS, CANOPIES WILL VARY IN SIZE DUE TO SIZE OF THE DRIVER/BALLAST THAT WILL BE LOCATED INSIDE OF THE CANOPY.

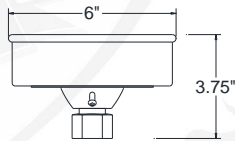

**LSLC 1/2"** LED SLOPE CEILING CANOPY



**LSTC 1/2"** LED STEM MOUNT CANOPY

**F – LIGHT SOURCE**

BASELITE'S PUBLISHED LUMINAIRE PHOTOMETRIC TESTING WAS PERFORMED IN A 3-METER INTEGRATING SPHERE USING THE 4TT GEOMETRY METHOD. DATA IS CONSIDERED TO BE REPRESENTATIVE OF THE CONFIGURATIONS SHOWN, WITHIN THE TOLERANCES ALLOWED BY LIGHTING FACTS. TO OBTAIN AN IES FILE SPECIFIC TO YOUR PROJECT, PLEASE CONTACT THE FACTORY.

**LIGHT EMITTING DIODE (LED)**

**LED 100W (MAX)** – LCN30, ODB25, MN27, PEC18, PEY, MW529

**\*IMPORTANT** – FOR LIGHT EMITTED DIODE (LED) LIGHT SOURCE OPTION, FIXTURES ARE LIMITED DUE TO SIZE OF THE FIXTURE AND THE CORD WATTAGE RESTRICTIONS. PLEASE SEE MAX WATTAGE AVAILABILITY. **EXAMPLE: / LED75W /**

OPTION	WATTAGE	LUMENS	CRI	VOLTAGE	DIMMING
LED10W	10W	1280	>90	120-277 VAC	See section "H"
LED12W	12W	1481	>90	120-277 VAC	See section "H"
LED25W	25W	2812	>90	120-277 VAC	See section "H"
LED35W	35W	3743	>90	120-277 VAC	See section "H"
LED50W	50W	5750	>90	120-277 VAC	See section "H"
LED80W	80W	8800	>90	120-277 VAC	See section "H"
LED100W	100W	10500	>90	120-277 VAC	See section "H"

@ 3500K





**H – ELECTRICAL OPTION**

MOST BASELITE’S ELECTRICAL OPTIONS ARE ONLY COMPATIBLE FOR CERTAIN FIXTURES. PLEASE SEE NOTES BELOW AND FOR FURTHER DETAILS CONTACT THE FACTORY. FOR DIMMING BALLAST OPTION, PLEASE CHOOSE MARK X OR MARK VII, SO RESTRICTIONS APPLY DUE TO THE SIZE OF THE BALLAST AND FIXTURE.

**LED DIMMING OPTIONS**

FOR TRIAC OR 0-10V OPTOIN CHOOSE FROM THE FOLLOWING. CONTACT DRIVER MANUFACTURER FOR SPECIFICATIONS.

**LDM120** - TRIAC DIMMING AT 120 VOLT

**LDM277** - TRIAC DIMMING AT 277 VOLT

**LDM0-10V** – 0 – 10v

**J – ACCESSORIES**



**CRL18** 18" CURVED POLYCARD LENS

**CRL19** 19" CURVED POLYCARD LENS

**CRL25** 25" CURVED POLYCARD LENS

**CRL27** 27" CURVED POLYCARD LENS

**CRL29** 29" CURVED POLYCARD LENS

**CRL30** 30" CURVED POLYCARD LENS

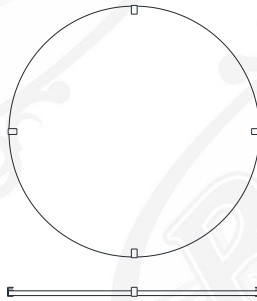

**FLE18** 18" FLAT CLEAR LENS

**FLE19** 19" FLAT CLEAR LENS

**FLE25** 25" FLAT CLEAR LENS

**FLE27** 27" FLAT CLEAR LENS

**FLE29** 29" FLAT CLEAR LENS

**FLE30** 30" FLAT CLEAR LENS



**BLE30** 30" FLAT LENSE WITH BAND

**\*LCN30 ONLY**

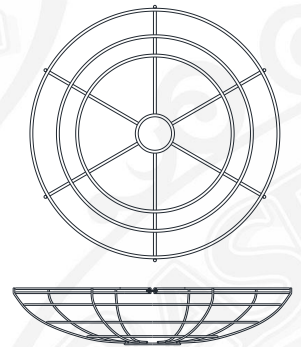

**GR30** 30" WIRE GRILL

**\*LCN30 ONLY**