



# BASELITE – OVERSIZED PENDANTS – INC – SPEC SHEET



PROJECT NAME: \_\_\_\_\_ PROJECT TYPE: \_\_\_\_\_

MODEL #	/	/	/	/	/	/	/	X	/	X	/	X	/	X	/	X
EXAMPLE:	A	B	C	D	E	F	G	H	I	J	K					
	3TD	80-59-81	BLC	CNK	41	150INC										

NOTES:



## A - SHADES

### OVERSIZED PENDANTS

- LCN30 – 150W INC (MAX)
- ODB25 – 150W INC (MAX)
- MN27 – 150W INC (MAX)
- PEC18 – 150W INC (MAX)
- PEY – 150W INC (MAX)
- MW529 - 150W INC (MAX)

## B - FINISH OPTIONS

(SEE WEBSITE FOR SWATCH COLORS)  
 (\*SEE NOTES FOR LIMITATIONS\*)  
 14, 15, 16, 17, 18, 19, 19P, 20, 20P,  
 20PB, 20SB, 21, 21P, 22, 22P, 23, 23P,  
 38, 39, 40, 41, 41.5, 42, 43, 44, 45, 46,  
 48, 49, 50, 51, 52, 53, 54, 55, 57, 58, 59,  
 60, 61, 62, 63, 64, 65, 66, 70, 71, 72, 73,  
 74, 75, 76, 77, 78, 79, 80, 81, 82, 83, 84,  
 85, 86, 87, 88, 89, 90, 91, 92, 93, 94, 95,  
 96, 97, 98, 99, 100, MG.

## C – MOUNTING OPTIONS

- CORD MOUNT (INC)**  
CBLC, CWHC
- STEM MOUNT (INC)**  
ST6, ST12, ST18, ST24, ST36, ST48, STXX

## D – MOUNTING ADD-ONS

- INC ADD-ONS**  
STC ½" – STEM MOUNT CANOPY  
SLC ½" – SLOPE CEILING CANOPY

## E – MOUNTING COLOR

SEE SECTION "B" FOR COLOR OPTIONS.

## F – LIGHT SOURCE

- (SEE PAGE 2 FOR WATTAGE LIMITATIONS)
- INCANDESCENT (INC)**  
100W, 150W

\*NOTE – MAX WATTAGE IS LISTED NEXT TO THE SHADE MODEL NUMBER IN SECTION "A". ALL WATTAGES BELOW THAT ARE ALSO AVAILABLE FOR THE SAME MODEL NUMBER.

## G – LED COLOR TEMP

NOT AVAILABLE

## H – ELECTRICAL OPTION

NOT AVAILABLE

## I – GLASS OPTIONS

N/A

## J – ACCESSORIES

- CRL18, CRL19, CRL25, CRL27, CRL29, CRL30, FLE18, FLE19, FLE25, FLE27, FLE29, FLE30, GR30, BLE30

## K – ACCESSORY COLOR

SEE SECTION "B" FOR COLOR OPTIONS.

## NOTES

- (1). FINISH OPTIONS 20, 21, 22, 23 ARE FOR SOLID BRASS FIXTURES ONLY.
  - (2). FINISH OPTIONS 19, 21, 22, 23, 75, 76, 77, 83, 84, 88, 93 AND 98 ARE APPLIED BY HAND. THESE FINISHES WILL VARY IN CONSISTENCY.
  - (3). FINISH OPTIONS FOR SHADES ≤ 10" IN DIAMETER ARE THE SAME INSIDE AND OUT OF FIXTURE. SHADES > 10" IN DIAMETER ARE WHITE ON THE INSIDE.
  - (4). FINISH OPTIONS 19, 38, 39, 40, 49, 54, 57, 58, 61, 62, 63, 70, 71, 72, 73, 78, 83, 84, 88, 92, 93, 98 ONLY AVAILABLE INSIDE AND OUT OF FIXTURE. OTHER FINISHES ARE WHITE INSIDE.
  - (5). FINISH OPTIONS 61, 62, 70, 71, 72, 73 ARE FINISHED WITH A SUPERCHROME ON THE INSIDE FOR ALL LED LIGHT SOURCE OPTIONS.
- \*ALL FIXTURES MOUNT TO A 4-O JUNCTION BOX.  
 \*FIXTURE DIMENSIONS MAY VARY ±0.25.

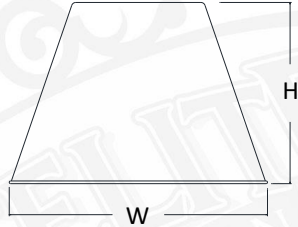

**LCN30** H-21" W-30"

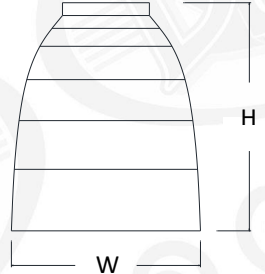

**PEC18** H-22" W-18.5"

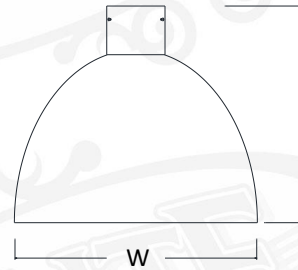

**ODB25** H-22.25" W-25"

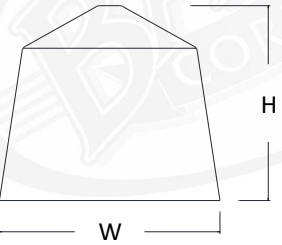

**PEY** H-16.75" W-19"

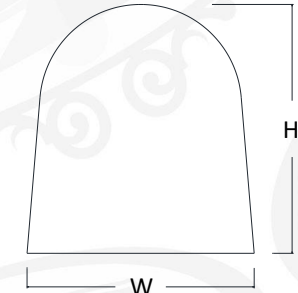

**MN27** H-29.5" W-27"

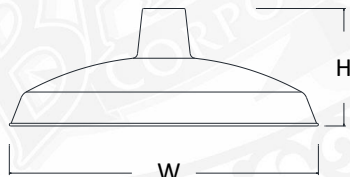

**MW529** H-11" W-29"



**C - MOUNTING OPTIONS**

**STEM MOUNT**

\*STEMS RATED FOR DAMP LOCATION \* 1/4" NPT AND 3/4" NPT AVAILABLE UPON REQUEST



**ST(XX)** STEM- 1/2" NPT

XX = LENGTH OF STEM  
(EXAMPLE – "ST18" = STEM MOUNT 18" LENGTH)  
\*CANOPY NOT INCLUDED, ADD IN SECTION D

**INCANDESCENT CORD MOUNTS**

\*INCANDESCENT MAX WATTAGE 150 WATT. CALL FACTORY FOR HIGHER WATTAGES. LOOPS, CABLES, AND CHAINS AVAILABLE ONLY FOR INCANDESCENT \*CORDS RATED FOR DRY LOCATION  
\*CANOPY DIMENSIONS: .625" (H) 5.25" (W)



**CBLC** 8' BLACK CORD and CABLE

**CWLC** 8' WHITE CORD and CABLE

**D - MOUNTING ADD-ONS**

**INCANDESCENT - STEM AND ARM ADD-ONS**

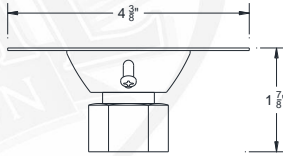

**SLC 1/2"** SLOPE CEILING CANOPY 1/2"

\*(Slopes To 20 Degrees)

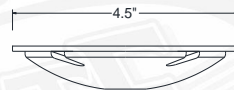

**STC 1/2"** 1/2" STEM MOUNT CANOPY

**F – LIGHT SOURCE**

BASELITE'S PUBLISHED LUMINAIRE PHOTOMETRIC TESTING WAS PERFORMED IN A 3-METER INTEGRATING SPHERE USING THE 4TT GEOMETRY METHOD. DATA IS CONSIDERED TO BE REPRESENTATIVE OF THE CONFIGURATIONS SHOWN, WITHIN THE TOLERANCES ALLOWED BY LIGHTING FACTS. TO OBTAIN AN IES FILE SPECIFIC TO YOUR PROJECT, PLEASE CONTACT THE FACTORY.

**INCANDESCENT (INC) MED E26**

**INC 150W (MAX) – LCN30, ODB25, MN27, PEC18, PEY, MW529**

\*IMPORTANT – FOR LIGHT EMITTED DIODE (LED) LIGHT SOURCE OPTION, FIXTURES ARE LIMITED DUE TO SIZE OF THE SIZE OF THE DRIVER.

EXAMPLE: / 150INC /

OPTION	WATTAGE	LUMENS	CRI	VOLTAGE	DIMMING
100WINC	100W	PER BULB SPECS	>90	120-277 VAC	N/A
150WINC	150W	PER BULB SPECS	>90	120-277 VAC	N/A



J – ACCESSORIES

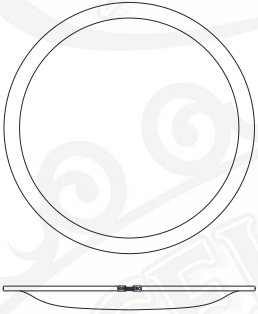

- CRL18** 18" CURVED POLYCARD LENS
- CRL19** 19" CURVED POLYCARD LENS
- CRL25** 25" CURVED POLYCARD LENS
- CRL27** 27" CURVED POLYCARD LENS
- CRL29** 29" CURVED POLYCARD LENS
- CRL30** 30" CURVED POLYCARD LENS

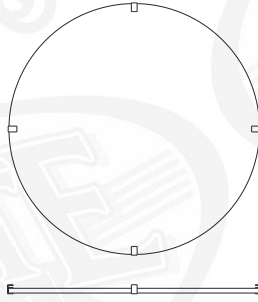

- FLE18** 18" FLAT CLEAR LENS
- FLE19** 19" FLAT CLEAR LENS
- FLE25** 25" FLAT CLEAR LENS
- FLE27** 27" FLAT CLEAR LENS
- FLE29** 29" FLAT CLEAR LENS
- FLE30** 30" FLAT CLEAR LENS

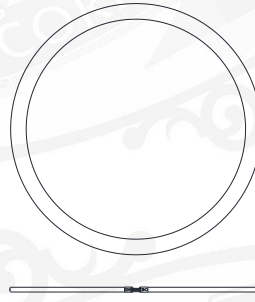

- BLE30** 30" FLAT LENSE WITH BAND
- \*LCN30 ONLY**

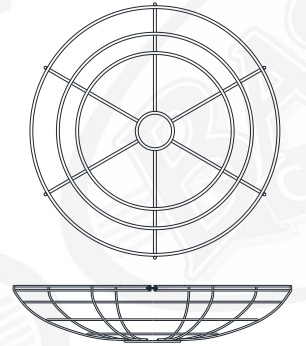

- GR30** 30" WIRE GRILL
- \*LCN30 ONLY**