



FOOD WARMER

MODEL : FW18

UL_{US-CA} Listed NSF Approved

SHOWN : FW18/58/BLC/250WCC

MATERIAL – ALUMINUM

HEIGHT – 13.5"

WIDTH – 6.25"

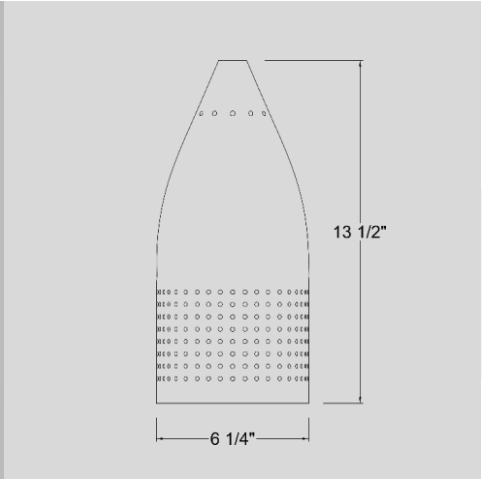

SPECIFICATIONS

- **Finish** – Five stage pretreatment process, coated with a lead free TGI C polyester powder coat finish. Same color in and out of reflectors. See color chart below for color options. Some finish options are not available for certain fixtures. Custom color options are available upon request.
- **Lamp – Food Warmer** – medium base porcelain socket, copper shell with nickel plate, rated 250v, 660W. 250 or 375 Watt Infrared R40 Bulb. Available in clear shatter proof coated.
- **Decorative Applications** – Can accommodate LED, Compact Fluorescent, Incandescent, or High Intensity Discharge (H.I.D.).
- **Mounting** – Available with cord (BLC, WHC), cord and cable (TCB, TCW), retractable telephone cord and cable (PTB, PTW), non-retractable telephone cord and cable (TLB, TLW), flexible stem (FA), rigid stem (ST), or horizontal arm (AM). Supplied with 1/2" tapped hub with ST, AM, and FA. FA available in 12", 18", or 24". ST standard 12", available in custom lengths, minimum 6". AM standard 11", available in custom lengths, restrictions apply. ST finish will match fixture finish. Fixtures are pre-wired with 48" or 96" leads or 96" cord.
- **Accessories** - Available with canopy mounted (TSC), fixture mounted (TSF), or remote switch (TSR). Available with track adapter (ADP) and track (HTR). HTR available in 4', black or white.
- **Reflector** – Spun from heavy gauge 1100-0 aluminum, ranging in thickness from .050 to .125. Copper is spun from .040 gauge 110 soft alloy. Brass is spun from 40 gauge

FOOD WARMER OPTIONS

STYLE	FINISH OPTIONS	BULB OPTION	MOUNTING OPTION	ACCESSORY OPTION
FW18	14PN, 20PB, 20SB, 21P, 40, 41, 42, 43, 44, 45, 48, 49, 50, 51, 52, 53, 57, 58, 59, 61, 62, 70, 71, 74, 75, 76, 79, 81, 84, 87, 88, 90, 93, 95, 97	250WCC 375WCC	BLC, WHC TCB, TCW TLB, TLW PTB, PTW FA12, FA18, FA24 ST12 AM11 TP	TSC TSF ¹ TSR HTRB-4 HTRW-4 ADP

1. not available with 375 watt bulb.

*SUBJECT TO MODIFICATION WITHOUT NOTIFICATION.

EXAMPLE : / FWPN / 41 / 250WCC / TLB / TSF

