



BASELITE - TAVERN – INC – SPECIFICATION SHEET



PROJECT NAME: _____ PROJECT TYPE: _____

MODEL #	/	/	/	/	/	/	/	/	/	/	/
	A	B	C	D	E	F	G	H	I	J	K
EXAMPLE:	TA12	41	E16	SQ 1/2"	43	45W	3K	LDM120	PR3	GR12	44

*SKIP SECTION IF OPTION DOES NOT APPLY

NOTES:



A - SHADES

TAVERN

- TA8 - 100WINC (MAX)
- TA12 - 150WINC (MAX)
- TA14 - 150WINC (MAX)
- TA16 - 200WINC (MAX)
- TA18 - 200WINC (MAX)
- TAR14 - 150WINC (MAX)
- TAR16 - 200WINC (MAX)
- TAR18 - 200WINC (MAX)
- TAN16 - 200WINC (MAX)

B - FINISH OPTIONS

(SEE WEBSITE FOR SWATCH COLORS)
 (*SEE NOTES FOR LIMITATIONS*)
 14, 15, 16, 17, 18, 19, 19P, 20, 20P, 20PB,
 20SB, 21, 21P, 22, 22P, 23, 23P, 38, 39, 40,
 41, 41.5, 42, 43, 44, 45, 46, 48, 49, 50, 51,
 52, 53, 54, 55, 57, 58, 59, 60, 61, 62, 63, 64,
 65, 66, 70, 71, 72, 73, 74, 75, 76, 77, 78, 79,
 80, 81, 82, 83, 84, 85, 86, 87, 88, 89, 90, 91,
 92, 93, 94, 95, 96, 97, 98, 99, 100, MG.

C - MOUNTING OPTIONS

- 1/2" ARM EXTENSIONS**
E1, E2, E3, E4, B1, E16, E17, E27
- 3/4" ARM EXTENSIONS**
E3A, E4A, E5, E6, E7, E8, E9,
E10, E11, E12, E13, B15, B15S,
E19, E20, E21, E25
- E14 - CREATE YOUR OWN**
(BASELITE WILL TAKE YOUR SKETCH AND
FABRICATE A CUSTOM ARM EXTENSION TO
MEET YOUR NEEDS).
- 1/4" WALL MOUNT**
WM28
- 1/2" WALL MOUNT**
B13, WM13, WM13R, WM13X, B10,
B11, B101
- 3/4" WALL MOUNT**
B9, B9C, B12, WM10, WM11, WM14,
WM14X, WM15, WM35X, WM55,
WM55X, WM60, WM60X, WM61,
WM61X WM70, WM70X, WM71,
WM71X
- CORD MOUNT**
BLC, WHC, TCB, TCW, TCHB, TCHW, TLB,
TLW, TLB, TLW, RCB, RCW, RCHB, RCHW,
FHB, FHW, CBLC, CWHC, CHB, CHW
- STEM MOUNT**
ST6, ST12, ST18, ST24, ST36, ST48, STXX

D - MOUNTING ADD-ONS

- INC ADD-ONS**
CB1/2", CB3/4", CBC1/2", CBC3/4", SLC1/2"
SLC3/4" STC1/2"
- UNIVERSAL ADD-ONS**
SQ 1/2", SQ 3/4", FH 1/2", FH 3/4", TRB 1/2", TRB 3/4",
SWL, LGSWL, CNK, INB, RINB

E - MOUNTING COLOR

SEE SECTION "B" FOR COLOR OPTIONS.

F - LIGHT SOURCE

(SEE PAGE 4 FOR WATTAGE LIMITATIONS)
INCANDESCENT (INC)
 100W, 150W, 200W

G - LED COLOR TEMP

NOT AVAILABLE

H - ELECTRICAL OPTION

NOT AVAILABLE

I - GLASS OPTIONS

- CL3, CL4, CLT3, CLT4, BL3, BL4, RE3, RE4,
GR3, GR4, AH3, AH4, FR3, FR4, FRT3, FRT4,
PR3, PR4, BA, BAX, BAF, PR8, PR8F, FN, OC

J - ACCESSORIES

- GR8, GR12, GR14, GR16, GR18, REF, UGR,
LGR8, LGR12, LGR14, LGR16, LGR18, CRL8,
CRL12, CRL14, CRL16, CRL18, FLE8, FLE12,
FLE14, FLE16, FLE18, FGR8, FGR12, FGR14,
FGR16, FGR18, GU-1, GU-2, WG-1, WG-2

K - ACCESSORY COLOR

SEE SECTION "B" FOR COLOR OPTIONS.

NOTES

- (1). FINISH OPTIONS 75, 76, 77, 83, 84, 88, 93 AND 98 ARE APPLIED BY HAND. THESE FINISHES WILL VARY IN CONSISTENCY.
- (2). FINISH OPTIONS 38, 39, 40, 49, 54, 57, 58, 61, 62, 63, 70, 71, 72, 73, 78, 83, 84, 88, 92, 93, 98 ONLY AVAILABLE INSIDE AND OUT OF FIXTURE. OTHER FINISHES ARE WHITE INSIDE.
- (3). FINISH OPTIONS 61, 62, 70, 71, 72, 73 ARE FINISHED WITH A SUPERCHROME ON THE INSIDE FOR ALL LED LIGHT SOURCE OPTIONS.
- (4). COLOR CORDS ARE NOT APPLICABLE FOR LED OPTIONS.
 *ALL ARMS COME WITH A CAST BACKPLATE (CB1/2", CB3/4", LWTM, CFWTM, ECT.).
 *ACCORDING TO THE LIGHT SOURCE THE BACKPLATE MAY VARY IN SIZE. (EXAMPLE: LED LIGHT SOURCE WILL HAVE A DEEPER BACKPLATE TO HOUSE THE DRIVER.)
 *ALL FIXTURES MOUNT TO A 4-O JUNCTION BOX.
 *FIXTURE DIMENSIONS MAY VARY ± 0.25.
 *CORD AND CANOPY COME IN THE SAME COLOR.

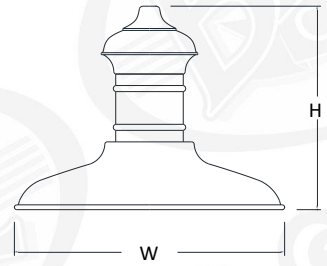

- TA8 H-9" W-8"
- TA12 H-10.5" W-12"
- TA14 H-10.5" W-14"
- TA16 H-10.5" W-16"
- TA18 H-11.5" W-18"

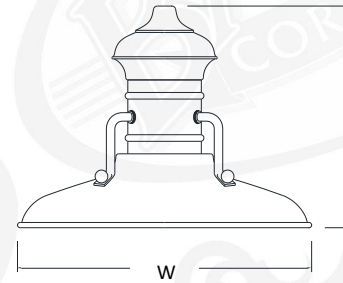

- TAR14 H-10.5" W-14"
- TAR16 H-10.5" W-16"
- TAR18 H-11.5" W-18"



TA8 H-9" W-8"

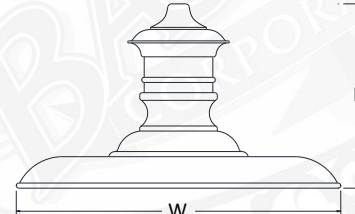

TAN16 H-9" W-16"



C - MOUNTING OPTIONS

1/2" ARM EXTENSIONS

*ARMS RATED FOR WET LOCATION * MAXIMUM SECTIONS OF ARMS ARE DIMENSIONED



E1 8.5"(H) 18.5"(W)



E2 18.5"(H) 35"(W)

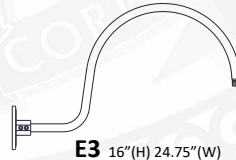

E3 16"(H) 24.75"(W)

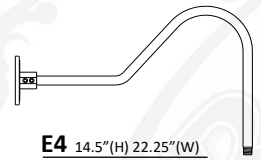

E4 14.5"(H) 22.25"(W)



B1 4"(H) 12"(W)



E16 4.75"(H) 8.5"(W)



E17 4.75"(H) 9.5"(W)



E27 8.875"(H) 10.5"(W)

3/4" ARM EXTENSIONS

*ARMS RATED FOR WET LOCATION * MAXIMUM SECTIONS OF ARMS ARE DIMENSIONED

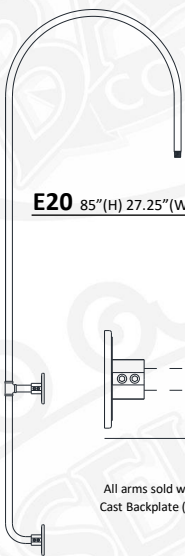

E20 85"(H) 27.25"(W)

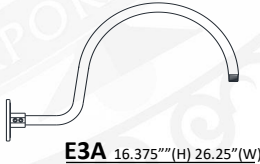

E3A 16.375"(H) 26.25"(W)

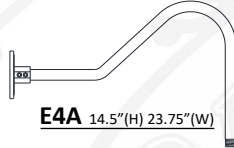

E4A 14.5"(H) 23.75"(W)

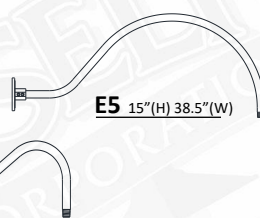

E5 15"(H) 38.5"(W)

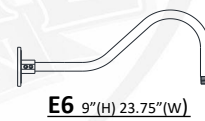

E6 9"(H) 23.75"(W)

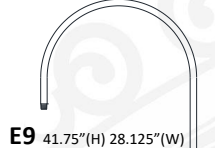

E9 41.75"(H) 28.125"(W)



E12 6(H) 39"(W)

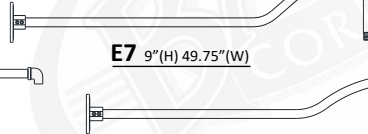

E7 9"(H) 49.75"(W)

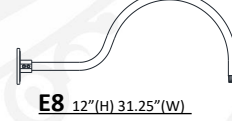

E8 12"(H) 31.25"(W)

Baselite will take your sketch and fabricate a custom arm extension to meet your

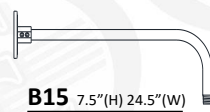

B15 7.5"(H) 24.5"(W)

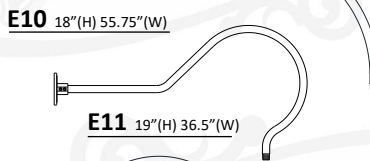

E11 18"(H) 55.75"(W)

E11 19"(H) 36.5"(W)

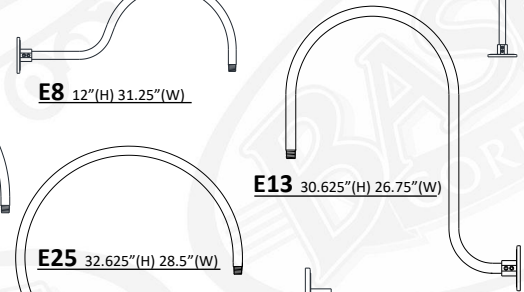

E13 30.625"(H) 26.75"(W)



All arms sold with Cast Backplate (CB)

E14 TBD"(H) TBD"(W)



B15S 7.5"(H) 19.5"(W)



E21 12.5"(H) 28.5"(W)

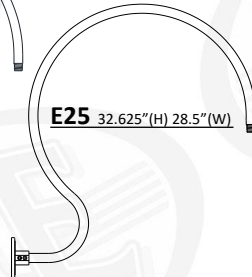

E25 32.625"(H) 28.5"(W)



E19 10.625"(H) 11.5"(W)

1/4" WALL MOUNT

*MOUNTS RATED FOR WET LOCATION * MAXIMUM SECTIONS OF MOUNTS ARE DIMENSIONED



WM28 13"(H) 10"(W)

1/2" WALL MOUNTS

*MOUNTS RATED FOR WET LOCATION * MAXIMUM SECTIONS OF MOUNTS ARE DIMENSIONED



B10 6"(H) 12.5"(W)



B101 6"(H) 13.5"(W)



B11 6"(H) 14.5"(W)



B13 6"(H) 16.5"(W)

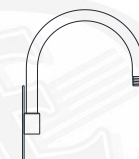

WM13 12"(H) 9.5"(W)

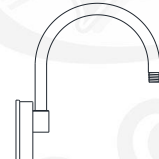

WM13R 12"(H) 9.5"(W)



WM13X 12"(H) 10.5"(W)



C - MOUNTING OPTIONS (CONTINUED)

3/4" WALL MOUNTS

*MOUNTS RATED FOR WET LOCATION * MAXIMUM SECTIONS OF MOUNTS ARE DIMENSIONED



B12 6"(H) 15.5"(W)



B9 5"(H) 18"(W)



B9C 5"(H) 18"(W)
*CHAIN HEIGHT TBD BY CUSTOMER

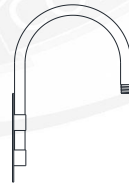

WM14 18"(H) 12"(W)

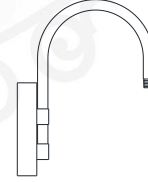

WM14X 18"(H) 14"(W)

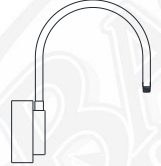

WM15 23"(H) 19.5"(W)

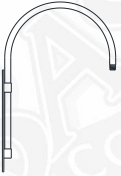

WM18 30"(H) 20"(W)



WM35 26"(H) 18.25"(W)



WM35X 26"(H) 22"(W)



WM55 19"(H) 25.5"(W)

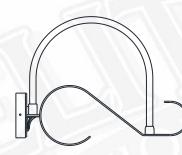

WM55X 19"(H) 27"(W)

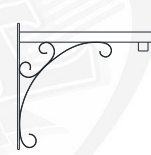

WM60 18"(H) 20"(W)

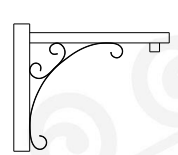

WM60X 18"(H) 22"(W)



WM61 18"(H) 20"(W)

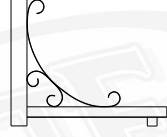

WM61X 18"(H) 22"(W)

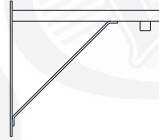

WM70 18"(H) 20"(W)

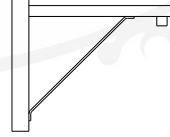

WM70X 18"(H) 22"(W)

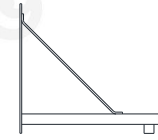

WM71 18"(H) 20"(W)

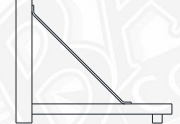

WM71X 18"(H) 22"(W)

STEM MOUNTS

*STEMS RATED FOR DAMP LOCATION

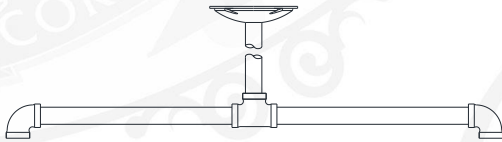

DP24 DOUBLE PENDANT 20"(H) 24"(W)

*DP24 COMES STANDARD WITH STC AND ST18



ST(XX) STEM- 1/2" NPT

XX = LENGTH OF STEM
(EXAMPLE -- "ST18" = STEM MOUNT 18" LENGTH)
*CANOPY NOT INCLUDED, ADD IN SECTION D
* 1/4" NPT AND 3/4" NPT AVAILABLE UPON REQUEST

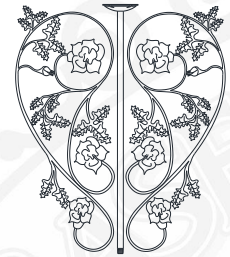

SC24 SCROLL STEM 33"(H) 24"(W)

*SC24 COMES STANDARD WITH STC

INCANDESCENT CORD MOUNTS

*INCANDESCENT MAX WATTAGE 150 WATT. CALL FACTORY FOR HIGHER WATTAGES. LOOPS, CABLES, AND CHAINS AVAILABLE ONLY FOR INCANDESCENT
*CORDS RATED FOR DRY LOCATION *CANOPY DIMENSIONS: .625" (H) 5.25" (W) *CORD AND CANOPY COME IN THE SAME COLOR.



BLC 8' BLACK CORD
WHC 8' WHITE CORD



TCB 8' BLACK CORD, CABLE, and LOOP
TCW 8' WHITE CORD, CABLE, and LOOP







TCHB 8' BLACK CORD, 3' CHAIN, and LOOP
TCHW 8' WHITE CORD, 3' CHAIN, and LOOP



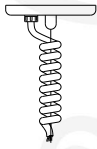
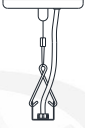

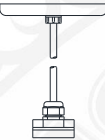
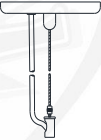

C - MOUNTING OPTIONS (CONTINUED)

INCANDESCENT CORD MOUNTS (CONTINUED)

 <p>TLB 8' BLACK TELEPHONE CORD AND CABLE TLW 8' WHITE TELEPHONE CORD AND CABLE * Not available H.I.D.</p>	 <p>RCB 8' BLACK CORD, CABLE, and LOOP RCW 8' WHITE CORD, CABLE, and LOOP</p>	 <p>RCHB 8' BLACK CORD, 3' CHAIN, and LOOP RCHW 8' WHITE CORD, 3' CHAIN, and LOOP</p>
 <p>FHB 8' BLACK CORD WITH FLAT HUB FHW 8' WHITE CORD WITH FLAT HUB</p>	 <p>CBLC 8' BLACK CORD and CABLE CWLC 8' WHITE CORD and CABLE</p>	 <p>CHB 8' BLACK CORD, 3' CHAIN, and LOOP CHW 8' WHITE CORD, 3' CHAIN, and LOOP * Loop may vary due to shade style</p>

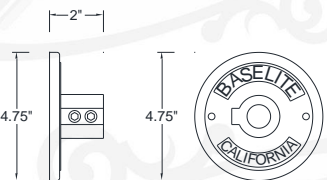
D - MOUNTING ADD-ONS

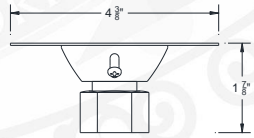

INCANDESCENT ARM ADD-ONS

 <p>CB 1/2" CAST ALUMINUM BACKPLATE 1/2 NPT CB 3/4" CAST ALUMINUM BACKPLATE 3/4 NPT</p>	 <p>CBC 1/2" 1/2" BACKPLATE COVER CBC 3/4" 3/4" BACKPLATE COVER * Includes slip ring to hold 1/2" or 3/4" arm extension in place</p>	 <p>SLC 1/2" SLOPE CEILING CANOPY 1/2" SLC 3/4" SLOPE CEILING CANOPY 3/4" *(Slopes To 20 Degrees)</p>	 <p>STC 1/2" 1/2" STEM MOUNT CANOPY</p>
--	--	--	--

UNIVERSAL STEM AND ARM ADD-ONS

* EXAMPLE FOR MULTIPLE MOUNTING ADD-ONS:

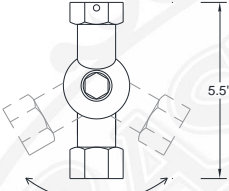
MODEL #: -/-/-/ LWTM, TRB X", LGSWL -/-/-/-/-/-/-/-/-
A B C D E F G H I J K

 <p>CNK CANOPY For MULTIPLE FIXTURES *CNK dimensions vary on number of fixtures applied</p>	 <p>LGSWL 1/2" NPT SWIVEL For all shades greater than 7" wide in diameter</p>	 <p>FH 1/2" FLAT HUB 1/2" FH 3/4" FLAT HUB 3/4"</p>	 <p>TRB 1/2"-4' Cable SUPPORT TRB 3/4"-4' Cable SUPPORT</p>
--	---	---	--

F - LIGHT SOURCE

BASELITE'S PUBLISHED LUMINAIRE PHOTOMETRIC TESTING WAS PERFORMED IN A 3-METER INTEGRATING SPHERE USING THE 4TT GEOMETRY METHOD. DATA IS CONSIDERED TO BE REPRESENTATIVE OF THE CONFIGURATIONS SHOWN, WITHIN THE TOLERANCES ALLOWED BY LIGHTING FACTS. TO OBTAIN AN IES FILE SPECIFIC TO YOUR PROJECT, PLEASE CONTACT THE FACTORY.

INCANDESCENT (INC) MED E26					
INC 100W- TA8 INC 150W- TA12, TA14, TAR14 INC 200W- TA16, TA18, TAR16, TAR18, TAN16			<p>*IMPORTANT – FOR INCANDESCENT (INC) LIGHT SOURCE OPTION, FIXTURES ARE LIMITED DUE TO SIZE OF THE FIXTURE AND THE CORD WATTAGE RESTRICTIONS. PLEASE SEE AVAILABILITY CHART TO THE LEFT.</p> <p>EXAMPLE: / INC100W /</p>		
OPTION	WATTAGE	LUMENS	CR	VOLTAGE	DIMMING
100WINC	100W	PER BULB SPECS	>90	120-277 VAC	N/A
150WINC	150W	PER BULB SPECS	>90	120-277 VAC	N/A
200WINC	200W	PER BULB SPECS	>90	120-277 VAC	N/A



I – GLASS OPTIONS

*NOTE: MUST USE TEMPERED GLASS FOR LIGHT FIXTURES USING HIGH INTENSITY DISCHARGE (HID) LIGHT SOURCE OPTION.



CL3 3" CLEAR GLASS



PR3 3" PRISMATIC GLASS



RE3 3" RED GLASS



BL3 3" BLUE GLASS

CL4 4" CLEAR GLASS

PR4 4" PRISMATIC GLASS

RE4 4" RED GLASS

BL4 4" BLUE GLASS

CLT3 3" CLEAR TEMPERED

CLT4 4" CLEAR TEMPERED



FR3 3" FROSTED GLASS



AH3 3" AMBER HYDE GLASS



GR3 3" GREEN GLASS

FR4 4" FROSTED GLASS

AH4 4" AMBER HYDE GLASS

GR4 4" GREEN GLASS

FRT3 3" FROSTED TEMPERED

FRT4 4" FROSTED TEMPERED

GLASS – DIMENSIONS	
3" GLASS	
Diameter	3.34"
Height	6.93"
Fitter	3.29"
4" GLASS	
Diameter	4.34"
Height	8.37"
Fitter	4.29"

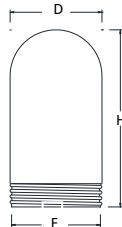

GLASS – MAX WATTAGE	
3" GLASS	– 100W INC / LED12W
4" GLASS	– 200W INC / LED25W



BA 6" OPAL BALL
(100W INC MAX/LED12W)



BAX 9" CLEAR GLOBE
BAF 9" FROSTED GLOBE
(200W INC MAX/LED25W)



FN 8" CLEAR TEXTURED GLOBE
(150W INC MAX/LED25W)



BA7 7" CLEAR GLOBE
BA7F 7" FROSTED GLOBE
(100W INC MAX/LED25W)



PR8 8" PRISMATIC
PR8F 8" PRISMATIC FROSTED
(200W INC MAX/LED45W)



OC 8" OPAL TAPERED GLOBE
(60W INC MAX/LED25W)

J – ACCESSORIES

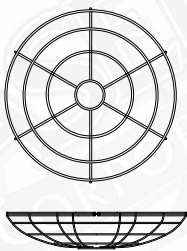

- GR8** 8" WIRE GRILL
- GR12** 12" WIRE GRILL
- GR14** 14" WIRE GRILL
- GR16** 16" WIRE GRILL
- GR18** 18" WIRE GRILL

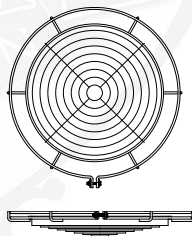

- LGR8** 8" LOUVERED GRILL
- LGR12** 12" LOUVERED GRILL
- LGR14** 14" LOUVERED GRILL
- LGR16** 16" LOUVERED GRILL
- LGR18** 18" LOUVERED GRILL

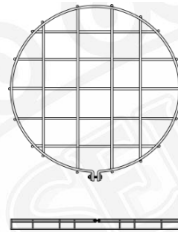

- FGR8** 8" FLAT GRILL
- FGR12** 12" FLAT GRILL
- FGR14** 14" FLAT GRILL
- FGR16** 16" FLAT GRILL
- FGR18** 18" FLAT GRILL



- CRL8** 8" CURVED POLYCARB LENSE
- CRL12** 12" CURVED POLYCARB LENSE
- CRL14** 14" CURVED POLYCARB LENSE
- CRL16** 16" CURVED POLYCARB LENSE
- CRL18** 18" CURVED POLYCARB LENSE

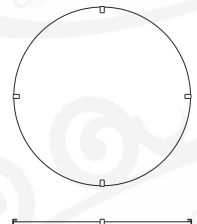

- FLE8** 8" FLAT CLEAR LENSE
- FLE12** 12" FLAT CLEAR LENSE
- FLE14** 14" FLAT CLEAR LENSE
- FLE16** 16" FLAT CLEAR LENSE
- FLE18** 18" FLAT CLEAR LENSE

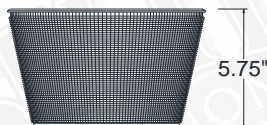

REF 9.5" DIAMETER REFRACTOR



UGR U- WIRE GUARD

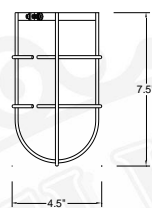

WG-1 WIRE GUARD

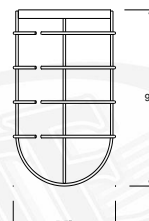

WG-2 WIRE GUARD

Available for shades
12" or higher

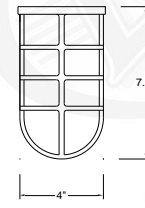

GU-1 CAST ALUMINUM GUARD

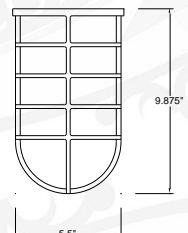

GU-2 CAST GUARD

Available for shades
12" or higher