



# BASELITE – REGENT – CF – SPECIFICATION SHEET



PROJECT NAME: \_\_\_\_\_ PROJECT TYPE: \_\_\_\_\_

MODEL #	/	/	/	/	/	/	/	/	/	/	/
EXAMPLE:	A RE12	B 41	C B10	D SQ ½"	E 43	F 25W	G 3K	H LDM120	I CL3	J GR12	K 44

\*SKIP SECTION IF OPTION DOES NOT APPLY

NOTES:



REW12/49/FR/WM28/100INC

## A - SHADES

### REGENT

- RE12 - 42WCF (MAX)
- REW12 - 42WCF (MAX)
- RE16 - 57WCF (MAX)
- RE18 - 57WCF (MAX)
- RE20 - 57WCF (MAX)
- REJ5FM - 32WCF (MAX)

## B - FINISH OPTIONS

(SEE WEBSITE FOR SWATCH COLORS)  
(\*SEE NOTES FOR LIMITATIONS\*)  
14, 15, 16, 17, 18, 19, 19P, 20, 20P, 20PB, 20SB, 21, 21P, 22, 22P, 23, 23P, 38, 39, 40, 41, 41.5, 42, 43, 44, 45, 46, 48, 49, 50, 51, 52, 53, 54, 55, 57, 58, 59, 60, 61, 62, 63, 64, 65, 66, 70, 71, 72, 73, 74, 75, 76, 77, 78, 79, 80, 81, 82, 83, 84, 85, 86, 87, 88, 89, 90, 91, 92, 93, 94, 95, 96, 97, 98, 99, 100, MG.

## C – MOUNTING OPTIONS

- ½" ARM EXTENSIONS**  
E1, E2, E3, E4, B1, E16, E17
- ¾" ARM EXTENSIONS**  
E3A, E4A, E5, E6, E7, E8, E9, E10, E11, E12, E13, B15, B15S, E19, E20, E21, E25
- E14 - CREATE YOUR OWN**  
(BASELITE WILL TAKE YOUR SKETCH AND FABRICATE A CUSTOM ARM EXTENSION TO MEET YOUR NEEDS).
- ¼" WALL MOUNT**  
WM28
- ½" WALL MOUNT**  
B13, WM13R, WM13X, B10, B11, B101
- ¾" WALL MOUNT**  
B9, B9C, B12, WM10, WM11, WM14X, WM15, WM35X, WM55X, WM60X, WM61X WM70X, WM71X
- COMPACT FLUORESCENT CORD MOUNT**  
CFBLC, CFWHC, CFTCB, CFTCW, CFTCHB, CFTCHW, CFTLB, CFTLW, CFRCB, CFRCW, CFRCHB, CFRCHW, CFFHB, CFFHW, CFHBLC, CFHWHC, CFCBLC, CFCWHC, CFCHB, CFCHW
- STEM MOUNT**  
ST6, ST12, ST18, ST24, ST36, ST48, STXX

## D – MOUNTING ADD-ONS

- CF ADD-ONS**  
CFWTM, CFSLC, CFSTC
- UNIVERSAL ADD-ONS**  
SQ ½", SQ ¾", FH ½", FH ¾", TRB ½", TRB ¾", SWL, LGSWL, CNK, INB, RINB

## E – MOUNTING COLOR

SEE SECTION "B" FOR COLOR OPTIONS.

## F – LIGHT SOURCE

(SEE PAGE 4 FOR WATTAGE LIMITATIONS)  
**COMPACT FLUORESCENT (CF)**  
26W, 32W, 42W, 57W

## G – LED COLOR TEMP

NOT AVAILABLE

## H – ELECTRICAL OPTION

(SEE PAGE 4 FOR DIMMING OPTION SPECIFICATIONS)  
**CDM120**  
**CDM277**  
**CDM120/277**

## I – GLASS OPTIONS

CL3, CL4, CLT3, CLT4, BL3, BL4, RE3, RE4, GR3, GR4, AH3, AH4, FR3, FR4, FRT3, FRT4, PR3, PR4, BA, BAX, BAF, PR8, PR8F, FN, OC

## J – ACCESSORIES

GR12, GR16, GR18, GR20, REF, UGR, LGR12, LGR16, LGR18, LGR20, CRL12, CRL16, CRL18, CRL20, FLE12, FLE16, FLE18, FLE20, FGR12, FGR16, FGR18, FGR20, GU-1, GU-2, WG-1, WG-2

## K – ACCESSORY COLOR

SEE SECTION "B" FOR COLOR OPTIONS.

## NOTES

- FINISH OPTIONS 75,76, 77, 83, 84, 88, 93 AND 98 ARE APPLIED BY HAND. THESE FINISHES WILL VARY IN CONSISTENCY.
  - FINISH OPTIONS 38, 39, 40, 49, 54, 57, 58, 61, 62, 63, 70, 71, 72, 73, 78, 83, 84, 88, 92, 93, 98 ONLY AVAILABLE INSIDE AND OUT OF FIXTURE. OTHER FINISHES ARE WHITE INSIDE.
  - FINISH OPTIONS 61, 62, 70, 71, 72, 73 ARE FINISHED WITH A SUPERCHROME ON THE INSIDE FOR ALL LED LIGHT SOURCE OPTIONS.
  - FINISH OPTIONS FOR SHADES ≤ 10" IN DIAMETER ARE THE SAME INSIDE AND OUT OF FIXTURE. SHADES > 10" IN DIAMETER ARE WHITE ON THE INSIDE.
  - COLOR CORDS ARE NOT APPLICABLE FOR LED OPTIONS.
- \*ALL ARMS COME WITH A CAST BACKPLATE (CB1/2", CB3/4", LWTM, CFWTM, ECT.).
  - \*ACCORDING TO THE LIGHT SOURCE THE BACKPLATE MAY VARY IN SIZE. (EXAMPLE: LED LIGHT SOURCE WILL HAVE A DEEPER BACKPLATE TO HOUSE THE DRIVER.).
  - \*ALL FIXTURES MOUNT TO A 4-O JUNCTION BOX.
  - \*FIXTURE DIMENSIONS MAY VARY ± 0.25.
  - \*CORD AND CANOPY COME IN THE SAME COLOR.

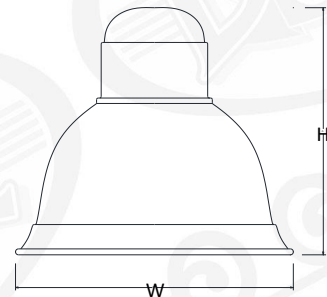

RE12	H-11"	W-12"
RE16	H-15"	W-16"
RE18	H-16"	W-18"
RE20	H-17.5"	W-20"

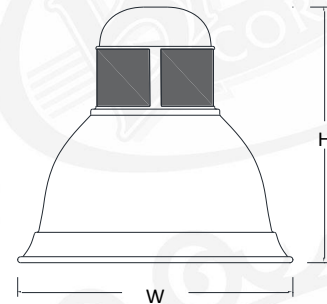

REW12	H-11"	W-12"
-------	-------	-------



REJ5FM	H-6"	W-8"
--------	------	------



**C - MOUNTING OPTIONS**

**1/2" ARM EXTENSIONS**

\*ARMS RATED FOR WET LOCATION \* MAXIMUM SECTIONS OF ARMS ARE DIMENSIONED

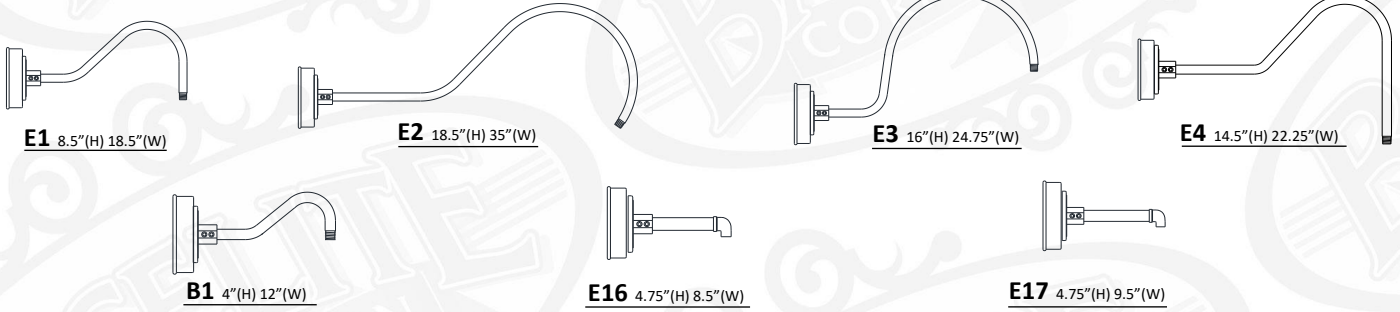

**3/4" ARM EXTENSIONS**

\*ARMS RATED FOR WET LOCATION \* MAXIMUM SECTIONS OF ARMS ARE DIMENSIONED

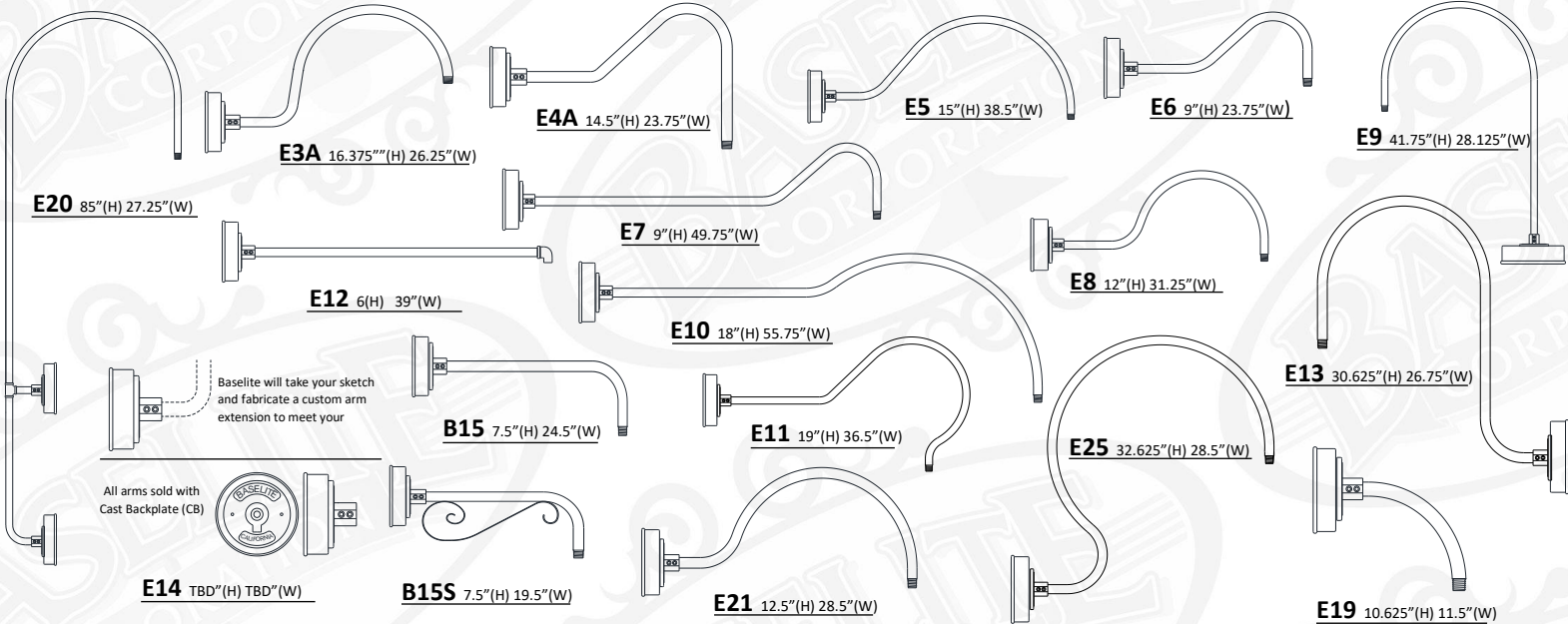

**1/4" WALL MOUNT**

\*MOUNTS RATED FOR WET LOCATION \* MAXIMUM SECTIONS OF MOUNTS ARE DIMENSIONED



**1/2" WALL MOUNTS**

\*MOUNTS RATED FOR WET LOCATION \* MAXIMUM SECTIONS OF MOUNTS ARE DIMENSIONED

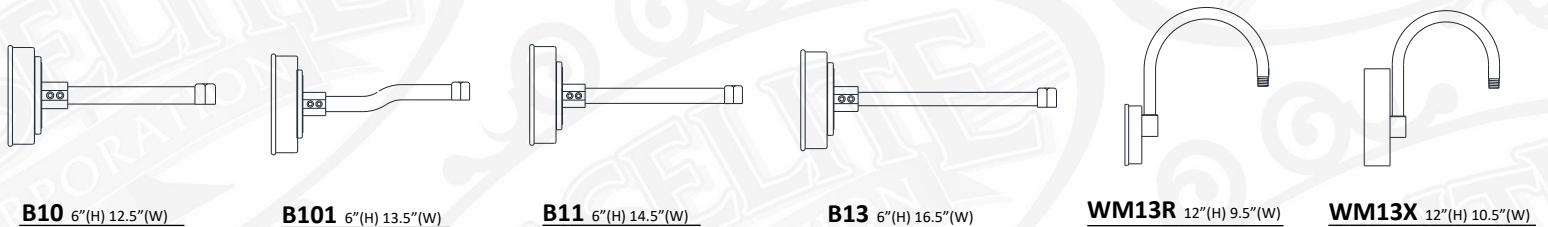



**3/4" WALL MOUNTS**

\*MOUNTS RATED FOR WET LOCATION \* MAXIMUM SECTIONS OF MOUNTS ARE DIMENSIONED



**B12** 6"(H) 15.5"(W)



**B9** 5"(H) 18"(W)

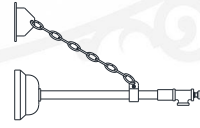

**B9C** 5"(H) 18"(W)  
\*CHAIN HEIGHT TBD BY CUSTOMER

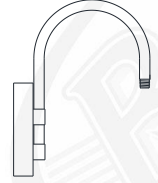

**WM14X** 18"(H) 14"(W)



**WM35X** 26"(H) 22"(W)



**WM55X** 19"(H) 27"(W)

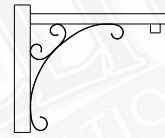

**WM60X** 18"(H) 22"(W)



**WM15** 23"(H) 19.5"(W)

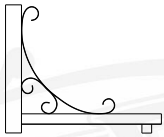

**WM61X** 18"(H) 22"(W)

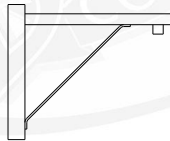

**WM70X** 18"(H) 22"(W)

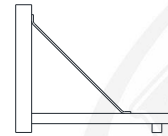

**WM71X** 18"(H) 22"(W)

**STEM MOUNTS**

\*STEMS RATED FOR DAMP LOCATION

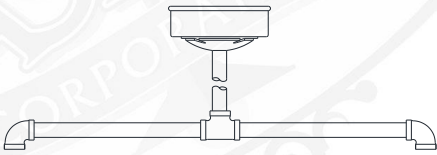

**DP24** DOUBLE PENDANT 20"(H) 24"(W)

\*DP24 COMES STANDARD WITH CFSTC AND ST18



**ST(XX)** STEM- 1/2" NPT

XX = LENGTH OF STEM  
(EXAMPLE -- "ST18" = STEM MOUNT 18" LENGTH)  
\*CANOPY NOT INCLUDED, ADD IN SECTION D  
\* 1/4" NPT AND 3/4" NPT AVAILABLE UPON REQUEST

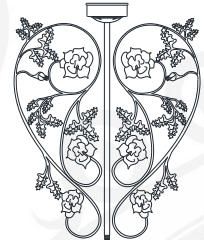

**SC24** SCROLL STEM 33"(H) 26"(W)

\*SC24 COMES STANDARD WITH CFSTC

**COMPACT FLUORESCENT CORD MOUNTS**

\*FOR LED & COMPACT FLUORESCENT OPTIONS, CANOPIES WILL VARY IN SIZE DUE TO SIZE OF THE DRIVER/BALLAST THAT WILL BE LOCATED INSIDE OF THE CANOPY.

\*CORDS RATED FOR DRY LOCATION \*CANOPY DIMENSIONS: 4" (H) 5.5" (W) \*CORD AND CANOPY COME IN THE SAME COLOR.



**CFBL** 8' BLACK CORD  
**CFWH** 8' WHITE CORD

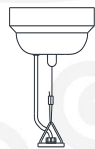

**CFCTB** 8' BLACK CORD, CABLE, and LOOP  
**CFCTW** 8' WHITE CORD, CABLE, and LOOP



**CFCTHB** 8' BLACK CORD, 3' CHAIN, and LOOP  
**CFCTHW** 8' WHITE CORD, 3' CHAIN, and LOOP



**CFRCB** 8' BLACK CORD, CABLE, and LOOP  
**CFRCW** 8' WHITE CORD, CABLE, and LOOP



**CFRCHB** 8' BLACK CORD, 3' CHAIN, and LOOP  
**CFRCHW** 8' WHITE CORD, 3' CHAIN, and LOOP



**CFCHB** 8' BLACK CORD, 3' CHAIN, and LOOP  
**CFCHW** 8' WHITE CORD, 3' CHAIN, and LOOP  
\* Loop may vary due to shade style





**I – GLASS OPTIONS**

\*NOTE: MUST USE TEMPERED GLASS FOR LIGHT FIXTURES USING HIGH INTENSITY DISCHARGE (HID) LIGHT SOURCE OPTION.



**CL3** 3" CLEAR GLASS



**PR3** 3" PRISMATIC GLASS



**RE3** 3" RED GLASS



**BL3** 3" BLUE GLASS

**CL4** 4" CLEAR GLASS

**PR4** 4" PRISMATIC GLASS

**RE4** 4" RED GLASS

**BL4** 4" BLUE GLASS

**CLT3** 3" CLEAR TEMPERED

**CLT4** 4" CLEAR TEMPERED



**FR3** 3" FROSTED GLASS



**AH3** 3" AMBER HYDE GLASS



**GR3** 3" GREEN GLASS

**FR4** 4" FROSTED GLASS

**AH4** 4" AMBER HYDE GLASS

**GR4** 4" GREEN GLASS

**FRT3** 3" FROSTED TEMPERED

**FRT4** 4" FROSTED TEMPERED

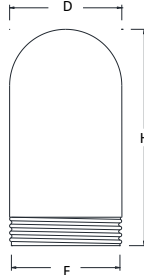

GLASS – DIMENSIONS  
3" GLASS

Diameter 3.34"  
Height 6.93"  
Fitter 3.29"

4" GLASS

Diameter 4.34"  
Height 8.37"  
Fitter 4.29"

GLASS – MAX WATTAGE  
3" GLASS – 100W INC / LED12W  
4" GLASS – 200W INC / LED25W



**BA** 6" OPAL BALL  
(100W INC MAX/LED12W)



**BAX** 9" CLEAR GLOBE  
**BAF** 9" FROSTED GLOBE  
(200W INC MAX/LED25W)



**FN** 8" CLEAR TEXTURED GLOBE  
(150W INC MAX/LED25W)



**BA7** 7" CLEAR GLOBE



**PR8** 8" PRISMATIC



**OC** 8" OPAL TAPERED GLOBE  
(60W INC MAX/LED25W)

**BA7F** 7" FROSTED GLOBE  
(100W INC MAX/LED25W)

**PR8F** 8" PRISMATIC FROSTED  
(200W INC MAX/LED45W)

**J – ACCESSORIES**

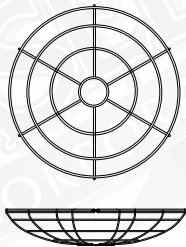

**GR12** 12" WIRE GRILL

**GR16** 16" WIRE GRILL

**GR18** 18" WIRE GRILL

**GR20** 20" WIRE GRILL

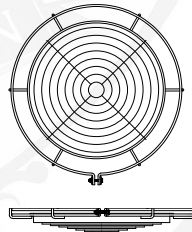

**LGR12** 12" LOUVERED GRILL

**LGR16** 16" LOUVERED GRILL

**LGR18** 18" LOUVERED GRILL

**LGR20** 20" LOUVERED GRILL

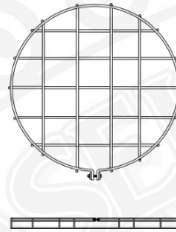

**FGR12** 12" FLAT GRILL

**FGR16** 16" FLAT GRILL

**FGR18** 18" FLAT GRILL

**FGR20** 20" FLAT GRILL



**CRL12** 12" CURVED POLYCARB LENS

**CRL16** 16" CURVED POLYCARB LENS

**CRL18** 18" CURVED POLYCARB LENS

**CRL20** 20" CURVED POLYCARB LENS

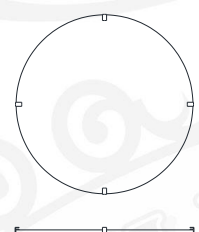

**FLE12** 12" FLAT CLEAR LENS

**FLE16** 16" FLAT CLEAR LENS

**FLE18** 18" FLAT CLEAR LENS

**FLE20** 20" FLAT CLEAR LENS

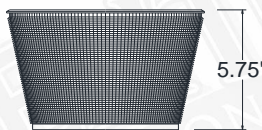

**REF** 9.5" DIAMETER REFRACTOR



**UGR** U- WIRE GUARD

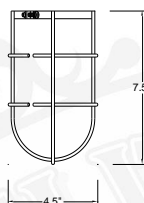

**WG-1** WIRE GUARD

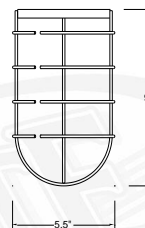

**WG-2** WIRE GUARD

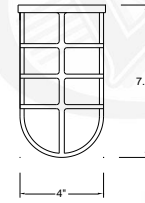

**GU-1** CAST ALUMINUM GUARD

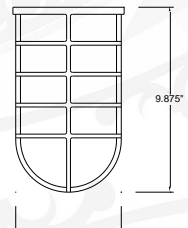

**GU-2** CAST GUARD