



BASELITE - ORBITOR – INC – SPECIFICATION SHEET



PROJECT NAME: _____ PROJECT TYPE: _____

MODEL #	/	/	/	/	/	/	/	/	/	/	/
EXAMPLE:	A	B	C	D	E	F	G	H	I	J	K
	ORB14	41	B10	SQ 1/2"	43	25W	3K	LDM120	PR3	-	44

*SKIP SECTION IF OPTION DOES NOT APPLY

NOTES:

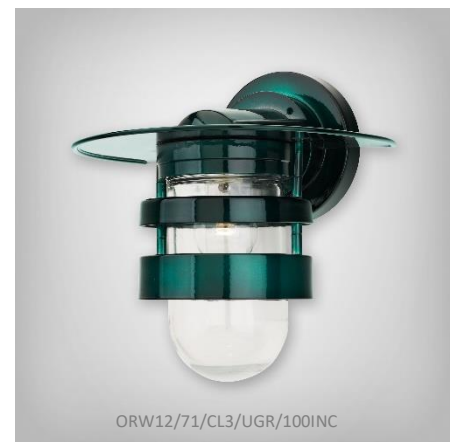

ORW12/71/CL3/UGR/100INC

A - SHADES

- ORBITOR**
ORB14 - 100WINC (MAX)
ORB19 - 200WINC (MAX)
ORF14 - 100WINC (MAX)
ORF19 - 200WINC (MAX)
ORW12 - 200WINC (MAX)

B - FINISH OPTIONS

(SEE WEBSITE FOR SWATCH COLORS)
 (**SEE NOTES FOR LIMITATIONS*)
 14, 15, 16, 17, 18, 19P, 20P, 20PB, 20SB,
 21P, 22P, 23P, 38, 39, 40, 41, 41.5, 42, 43,
 44, 45, 46, 48, 49, 50, 51, 52, 53, 54, 55, 57,
 58, 59, 60, 61, 62, 63, 64, 65, 66, 70, 71, 72,
 73, 74, 75, 76, 77, 78, 79, 80, 81, 82, 83, 84,
 85, 86, 87, 88, 89, 90, 91, 92, 93, 94, 95, 96,
 97, 98, 99, 100, MG.

C - MOUNTING OPTIONS

- 1/2" ARM EXTENSIONS**
 E1, E2, E3, E4, B1, E16, E17, E27
3/4" ARM EXTENSIONS
 E3A, E4A, E5, E6, E7, E8, E9,
 E10, E11, E12, E13, B15, B15S,
 E19, E20, E21, E25
E14 - CREATE YOUR OWN
 (BASELITE WILL TAKE YOUR SKETCH AND
 FABRICATE A CUSTOM ARM EXTENSION TO
 MEET YOUR NEEDS).
1/2" WALL MOUNT
 B13, WM13, WM13R, WM13X, B10,
 B11, B101
3/4" WALL MOUNT
 B9, B9C, B12, WM10, WM11, WM14,
 WM14X, WM15, WM35X, WM55,
 WM55X, WM60, WM60X, WM61,
 WM61X WM70, WM70X, WM71,
 WM71X
CORD MOUNT
 BLC, WHC, TCB, TCW, TCHB, TCHW, TLB,
 TLW, TLB, TLW, RCB, RCW, RCHB, RCHW,
 FHB, FHW, HBLC, HWHC, CBLC, CWHC
STEM MOUNT
 ST6, ST12, ST18, ST24, ST36, ST48, STXX

D - MOUNTING ADD-ONS

- INC ADD-ONS**
 CB1/2", CB3/4", CBC1/2", CBC3/4", SLC1/2"
 SLC3/4" STC1/2"
UNIVERSAL ADD-ONS
 SQ 1/2", SQ 3/4", FH 1/2", FH 3/4", TRB 1/2", TRB 3/4",
 SWL, LGSWL, CNK, INB, RINB

E - MOUNTING COLOR

SEE SECTION "B" FOR COLOR OPTIONS.

F - LIGHT SOURCE

(SEE PAGE 4 FOR WATTAGE LIMITATIONS)
INCANDESCENT (INC)
 100W, 150W, 200W

G - LED COLOR TEMP

NOT AVAILABLE

H - ELECTRICAL OPTION

NOT AVAILABLE

I - GLASS OPTIONS

- CL3, CL4, CLT3, CLT4, BL3, BL4, RE3, RE4,
 GR3, GR4, AH3, AH4, FR3, FR4, FRT3, FRT4,
 PR3, PR4

J - ACCESSORIES

NOT AVAILABLE

K - ACCESSORY COLOR

SEE SECTION "B" FOR COLOR OPTIONS.

NOTES

- (1). FINISH OPTIONS 75, 76, 77, 83, 84, 88, 93 AND 98 ARE APPLIED BY HAND. THESE FINISHES WILL VARY IN CONSISTENCY.
 - (2). FINISH OPTIONS 38, 39, 40, 49, 54, 57, 58, 61, 62, 63, 70, 71, 72, 73, 78, 83, 84, 88, 92, 93, 98 ONLY AVAILABLE INSIDE AND OUT OF FIXTURE. OTHER FINISHES ARE WHITE INSIDE.
 - (3). FINISH OPTIONS FOR SHADES ≤ 10" IN DIAMETER ARE THE SAME INSIDE AND OUT OF FIXTURE. SHADES > 10" IN DIAMETER ARE WHITE ON THE INSIDE.
 - (4). FINISH OPTIONS 61, 62, 70, 71, 72, 73 ARE FINISHED WITH A SUPERCHROME ON THE INSIDE FOR ALL LED LIGHT SOURCE OPTIONS.
 - (5). COLOR CORDS ARE NOT APPLICABLE FOR LED OPTIONS.
- *ALL ARMS COME WITH A CAST BACKPLATE (CB1/2", CB3/4", LWTM, CFWTM, ECT.).
 *ACCORDING TO THE LIGHT SOURCE THE BACKPLATE MAY VARY IN SIZE. (EXAMPLE: LED LIGHT SOURCE WILL HAVE A DEEPER BACKPLATE TO HOUSE THE DRIVER.).
 *ALL FIXTURES MOUNT TO A 4-0 JUNCTION BOX.
 *FIXTURE DIMENSIONS MAY VARY ± 0.25.
 *CORD AND CANOPY COME IN THE SAME COLOR.

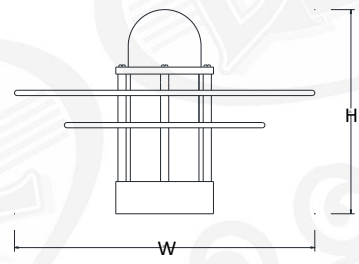

ORB14 H-9.5" W-14"
ORB19 H-12" W-19"

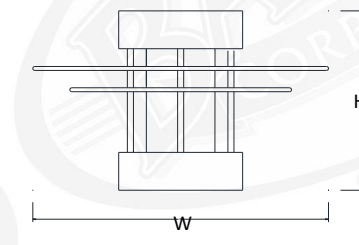

ORF14 H-9" W-14"
ORF19 H-11.25" W-19"

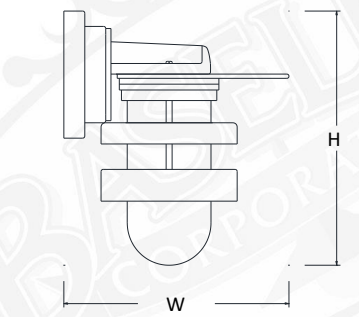

ORW12 H-12" W-10.75"



C - MOUNTING OPTIONS

1/2" ARM EXTENSIONS

*ARMS RATED FOR WET LOCATION * MAXIMUM SECTIONS OF ARMS ARE DIMENSIONED



E1 8.5"(H) 18.5"(W)



E2 18.5"(H) 35"(W)



E3 16"(H) 24.75"(W)

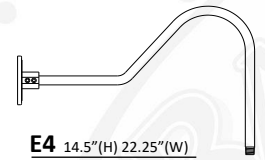

E4 14.5"(H) 22.25"(W)



B1 4"(H) 12"(W)



E16 4.75"(H) 8.5"(W)



E17 4.75"(H) 9.5"(W)

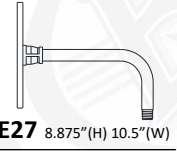

E27 8.875"(H) 10.5"(W)

3/4" ARM EXTENSIONS

*ARMS RATED FOR WET LOCATION * MAXIMUM SECTIONS OF ARMS ARE DIMENSIONED

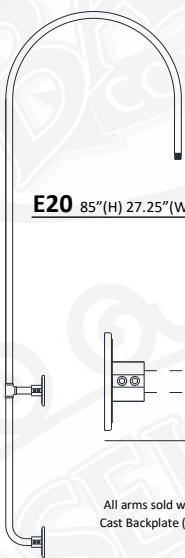

E20 85"(H) 27.25"(W)

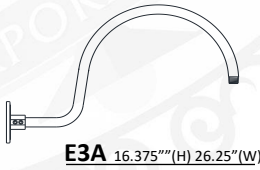

E3A 16.375"(H) 26.25"(W)

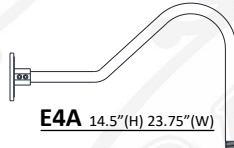

E4A 14.5"(H) 23.75"(W)

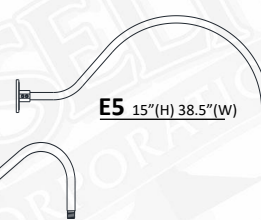

E5 15"(H) 38.5"(W)

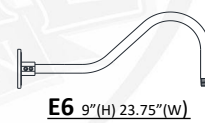

E6 9"(H) 23.75"(W)

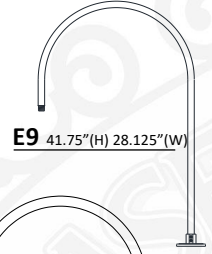

E9 41.75"(H) 28.125"(W)



E12 6(H) 39"(W)

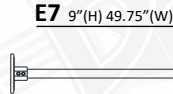

E7 9"(H) 49.75"(W)

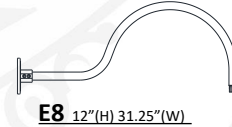

E8 12"(H) 31.25"(W)



Baselite will take your sketch and fabricate a custom arm extension to meet your

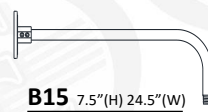

B15 7.5"(H) 24.5"(W)

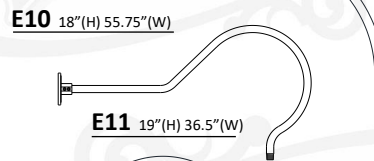

E10 18"(H) 55.75"(W)

E11 19"(H) 36.5"(W)

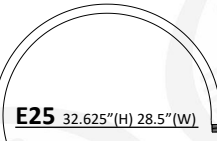

E25 32.625"(H) 28.5"(W)

E13 30.625"(H) 26.75"(W)

All arms sold with Cast Backplate (CB)



E14 TBD"(H) TBD"(W)

B15S 7.5"(H) 19.5"(W)



E21 12.5"(H) 28.5"(W)

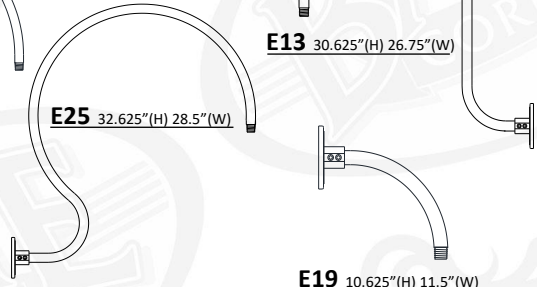

E19 10.625"(H) 11.5"(W)

1/2" WALL MOUNTS

*MOUNTS RATED FOR WET LOCATION * MAXIMUM SECTIONS OF MOUNTS ARE DIMENSIONED



B10 6"(H) 12.5"(W)



B101 6"(H) 13.5"(W)



B11 6"(H) 14.5"(W)



B13 6"(H) 16.5"(W)



WM13 12"(H) 9.5"(W)

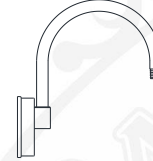

WM13R 12"(H) 9.5"(W)



WM13X 12"(H) 10.5"(W)

3/4" WALL MOUNTS

*MOUNTS RATED FOR WET LOCATION * MAXIMUM SECTIONS OF MOUNTS ARE DIMENSIONED



B12 6"(H) 15.5"(W)



B9 5"(H) 18"(W)

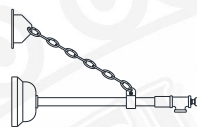

B9C 5"(H) 18"(W)

*CHAIN HEIGHT TBD BY CUSTOMER

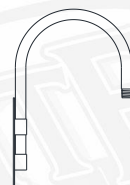

WM14 18"(H) 12"(W)

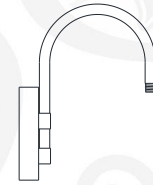

WM14X 18"(H) 14"(W)



WM15 23"(H) 19.5"(W)



C - MOUNTING OPTIONS (CONTINUED)

3/4" WALL MOUNTS

*MOUNTS RATED FOR WET LOCATION * MAXIMUM SECTIONS OF MOUNTS ARE DIMENSIONED

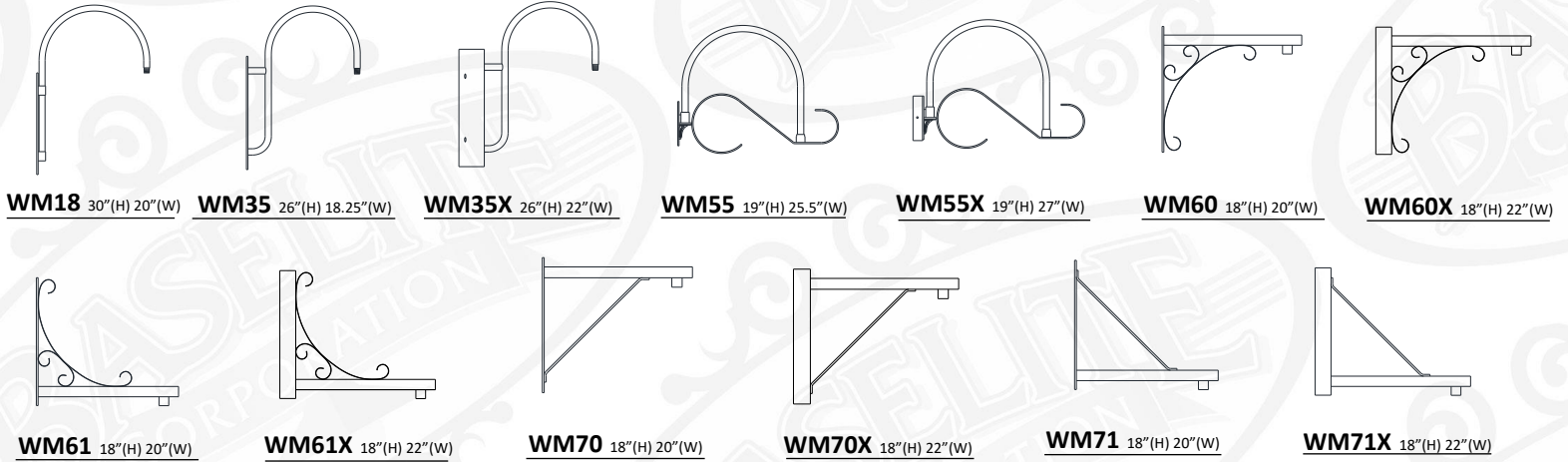

STEM MOUNTS

*STEMS RATED FOR DAMP LOCATION

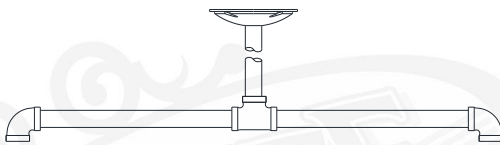

DP24 DOUBLE PENDANT 20"(H) 24"(W)

*DP24 COMES STANDARD WITH STC AND ST18



ST(XX) STEM- 1/2" NPT

XX = LENGTH OF STEM
(EXAMPLE - "ST18" = STEM MOUNT 18" LENGTH)
*CANOPY NOT INCLUDED, ADD IN SECTION D
* 1/4" NPT AND 3/4" NPT AVAILABLE UPON REQUEST



SC24 SCROLL STEM 33"(H) 24"(W)

*SC24 COMES STANDARD WITH STC

INCANDESCENT CORD MOUNTS

*INCANDESCENT MAX WATTAGE 150 WATT. CALL FACTORY FOR HIGHER WATTAGES. LOOPS, CABLES, AND CHAINS AVAILABLE ONLY FOR INCANDESCENT
*CORDS RATED FOR DRY LOCATION *CANOPY DIMENSIONS: .625" (H) 5.25" (W) *CORD AND CANOPY COME IN THE SAME COLOR.



BLC 8' BLACK CORD
WHC 8' WHITE CORD



TCB 8' BLACK CORD, CABLE, and LOOP
TCW 8' WHITE CORD, CABLE, and LOOP



TCHB 8' BLACK CORD, 3' CHAIN, and LOOP
TCHW 8' WHITE CORD, 3' CHAIN, and LOOP



TLB 8' BLACK TELEPHONE CORD AND CABLE
TLW 8' WHITE TELEPHONE CORD AND CABLE
* Not available H.I.D.



RCB 8' BLACK CORD, CABLE, and LOOP
RCW 8' WHITE CORD, CABLE, and LOOP



RCHB 8' BLACK CORD, 3' CHAIN, and LOOP
RCHW 8' WHITE CORD, 3' CHAIN, and LOOP



FHB 8' BLACK CORD WITH FLAT HUB
FHW 8' WHITE CORD WITH FLAT HUB



HBLC 8' BLACK CORD (H.I.D.)
HWHC 8' WHITE CORD (H.I.D.)
*(Remote ballast shades only)



CBLC 8' BLACK CORD and CABLE
CWLC 8' WHITE CORD and CABLE



D - MOUNTING ADD-ONS

INCANDESCENT ARM ADD-ONS

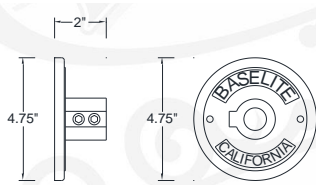

CB 1/2" CAST ALUMINUM BACKPLATE 1/2 NPT
CB 3/4" CAST ALUMINUM BACKPLATE 3/4 NPT

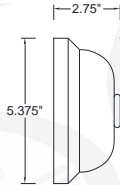

CBC 1/2" 1/2" BACKPLATE COVER
CBC 3/4" 3/4" BACKPLATE COVER
* Includes slip ring to hold 1/2" or 3/4" arm extension in place

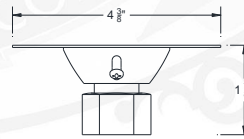

SLC 1/2" SLOPE CEILING CANOPY 1/2"
SLC 3/4" SLOPE CEILING CANOPY 3/4"
*(Slopes To 20 Degrees)

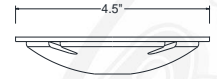

STC 1/2" 1/2" STEM MOUNT CANOPY

UNIVERSAL STEM AND ARM ADD-ONS

* EXAMPLE FOR MULTIPLE MOUNTING ADD-ONS:

MODEL #: ---/---/---/---
A B C D E F G H I J K



CNK CANOPY For MULTIPLE FIXTURES
*CNK dimensions vary on number of fixtures applied

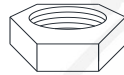

LGSWL 1/2" NPT SWIVEL
For all shades greater than 7" wide in diameter

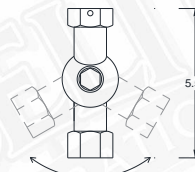

FH 1/2" FLAT HUB 1/2"
FH 3/4" FLAT HUB 3/4"



TRB 1/2"-4' Cable SUPPORT
TRB 3/4"-4' Cable SUPPORT

F - LIGHT SOURCE

BASELITE'S PUBLISHED LUMINAIRE PHOTOMETRIC TESTING WAS PERFORMED IN A 3-METER INTEGRATING SPHERE USING THE 4TT GEOMETRY METHOD. DATA IS CONSIDERED TO BE REPRESENTATIVE OF THE CONFIGURATIONS SHOWN, WITHIN THE TOLERANCES ALLOWED BY LIGHTING FACTS. TO OBTAIN AN IES FILE SPECIFIC TO YOUR PROJECT, PLEASE CONTACT THE FACTORY.

INCANDESCENT (INC) MED E26

INC 100W- ORB14, ORF14
INC 200W- ORB19, ORF19, ORW12

*IMPORTANT - FOR INCANDESCENT (INC) LIGHT SOURCE OPTION, FIXTURES ARE LIMITED DUE TO SIZE OF THE FIXTURE AND THE CORD WATTAGE RESTRICTIONS. PLEASE SEE AVAILABILITY CHART TO THE LEFT.

EXAMPLE: / INC100W /

OPTION	WATTAGE	LUMENS	CRI	VOLTAGE	DIMMING
100WINC	100W	PER BULB SPECS	>90	120-277 VAC	N/A
150WINC	150W	PER BULB SPECS	>90	120-277 VAC	N/A
200WINC	200W	PER BULB SPECS	>90	120-277 VAC	N/A

I - GLASS OPTIONS



CL3 3" CLEAR GLASS
CL4 4" CLEAR GLASS
CLT3 3" CLEAR TEMPERED
CLT4 4" CLEAR TEMPERED



PR3 3" PRISMATIC GLASS
PR4 4" PRISMATIC GLASS



RE3 3" RED GLASS
RE4 4" RED GLASS



BL3 3" BLUE GLASS
BL4 4" BLUE GLASS



FR3 3" FROSTED GLASS
FR4 4" FROSTED GLASS
FRT3 3" FROSTED TEMPERED
FRT4 4" FROSTED TEMPERED



AH3 3" AMBER HYDE GLASS
AH4 4" AMBER HYDE GLASS



GR3 3" GREEN GLASS
GR4 4" GREEN GLASS

GLASS - DIMENSIONS	
3" GLASS	Diameter 3.34"
	Height 6.93"
	Fitter 3.29"
4" GLASS	Diameter 4.34"
	Height 8.37"
	Fitter 4.29"

GLASS - MAX WATTAGE	
3" GLASS	100W INC / LED12W
4" GLASS	200W INC / LED25W

