



# BASELITE - NOVA – LED – SPECIFICATION SHEET



PROJECT NAME: \_\_\_\_\_ PROJECT TYPE: \_\_\_\_\_

MODEL #	/	/	/	/	/	/	/	/	/	/	/
EXAMPLE:	A LCD12	B 41	C E16	D SQ ½"	E 43	F 25W	G -	H -	I PR3	J -	K 44

\*SKIP SECTION IF OPTION DOES NOT APPLY

NOTES:



LCD12/43/BLC/PR4/150INC

## A - SHADES

### NOVA

- LC3 – 100WINC (MAX)
- LC4 – 200WINC (MAX)
- LCD12 – 200WINC (MAX)

## B - FINISH OPTIONS

(SEE WEBSITE FOR SWATCH COLORS)  
 (\*SEE NOTES FOR LIMITATIONS\*)  
 14, 15, 16, 17, 18, 19P, 20P, 20PB, 20SB,  
 21P, 22P, 23P, 38, 39, 40, 41, 41.5, 42, 43,  
 44, 45, 46, 48, 49, 50, 51, 52, 53, 54, 55, 57,  
 58, 59, 60, 61, 62, 63, 64, 65, 66, 70, 71, 72,  
 73, 74, 75, 76, 77, 78, 79, 80, 81, 82, 83, 84,  
 85, 86, 87, 88, 89, 90, 91, 92, 93, 94, 95, 96,  
 97, 98, 99, 100, MG.

## C – MOUNTING OPTIONS

- ½" ARM EXTENSIONS**  
E1, E2, E3, E4, B1, E16, E17, E27
- ¾" ARM EXTENSIONS**  
E3A, E4A, E5, E6, E7, E8, E9,  
E10, E11, E12, E13, B15, B15S,  
E19, E20, E21, E25
- E14 - CREATE YOUR OWN**  
(BASELITE WILL TAKE YOUR SKETCH AND  
FABRICATE A CUSTOM ARM EXTENSION TO  
MEET YOUR NEEDS).
- ½" WALL MOUNT**  
B10, B11, B101, B13, WM13, WM13R,  
WM13X
- ¾" WALL MOUNT**  
B9, B9C, B12, WM14, WM14X, WM15,  
WM18, WM35, WM35X, WM55, WM55X,  
WM60, WM60X, WM61, WM61X, WM70,  
WM70X, WM71, WM71X
- CORD MOUNT**  
BLC, WHC, TCB, TCW, TCHB, TCHW, TLB,  
TLW, TLB, TLW, RCB, RCW, RCHB, RCHW,  
FHB, FHW, HBLC, HWHC, CBLC, CWHC
- STEM MOUNT**  
ST6, ST12, ST18, ST24, ST36, ST48, STXX

## D – MOUNTING ADD-ONS

- INC ADD-ONS**  
CB1/2", CB3/4", CBC1/2", CBC3/4",  
SLC1/2", SLC3/4" STC1/2"
- UNIVERSAL ADD-ONS**  
SQ ½", SQ ¾", FH ½", FH ¾", TRB ½",  
TRB ¾", SWL, LGSWL, CNK

## E – MOUNTING COLOR

SEE SECTION "B" FOR COLOR OPTIONS.

## F – LIGHT SOURCE

(SEE PAGE 4 FOR WATTAGE LIMITATIONS)  
**INCANDESCENT (INC)**  
 100W, 200W

## G – LED COLOR TEMP

NOT AVAILABLE

## H – ELECTRICAL OPTION

NOT AVAILABLE

## I – GLASS OPTIONS

- CL3, CL4, CLT3, CLT4, BL3, BL4, RE3, RE4,  
GR3, GR4, AH3, AH4, FR3, FR4, FRT3, FRT4,  
PR3, PR4

## J – ACCESSORIES

NOT AVAILABLE

## K – ACCESSORY COLOR

SEE SECTION "B" FOR COLOR OPTIONS.

## NOTES

- FINISH OPTIONS 75, 76, 77, 83, 84, 88, 93 AND 98 ARE APPLIED BY HAND. THESE FINISHES WILL VARY IN CONSISTENCY.
- FINISH OPTIONS 38, 39, 40, 49, 54, 57, 58, 61, 62, 63, 70, 71, 72, 73, 78, 83, 84, 88, 92, 93, 98 ONLY AVAILABLE INSIDE AND OUT OF FIXTURE. OTHER FINISHES ARE WHITE INSIDE.
- FINISH OPTIONS FOR SHADES ≤ 10" IN DIAMETER ARE THE SAME INSIDE AND OUT OF FIXTURE. SHADES > 10" IN DIAMETER ARE WHITE ON THE INSIDE.
- FINISH OPTIONS 61, 62, 70, 71, 72, 73 ARE FINISHED WITH A SUPERCHROME ON THE INSIDE FOR ALL LED LIGHT SOURCE OPTIONS.
- COLOR CORDS ARE NOT APPLICABLE FOR LED OPTIONS.  
 \*ALL ARMS COME WITH A CAST BACKPLATE (CB1/2", CB3/4", LWTM, CFWTM, ECT.).  
 \*ACCORDING TO THE LIGHT SOURCE THE BACKPLATE MAY VARY IN SIZE. (EXAMPLE: LED LIGHT SOURCE WILL HAVE A DEEPER BACKPLATE TO HOUSE THE DRIVER.)  
 \*ALL FIXTURES MOUNT TO A 4-0 JUNCTION BOX.  
 \*FIXTURE DIMENSIONS MAY VARY ± 0.25.  
 \*CORD AND CANOPY COME IN THE SAME COLOR.

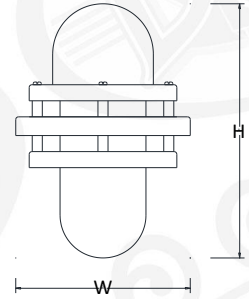

**LC3** H-9.5" W-6.5"  
**LC4** H-13" W-8"

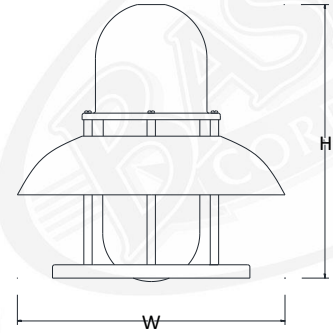

**LCD12** H-10" W-12"



**C - MOUNTING OPTIONS**

**1/2" ARM EXTENSIONS**

\*ARMS RATED FOR WET LOCATION \* MAXIMUM SECTIONS OF ARMS ARE DIMENSIONED



**E1** 8.5"(H) 18.5"(W)



**E2** 18.5"(H) 35"(W)

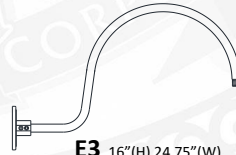

**E3** 16"(H) 24.75"(W)

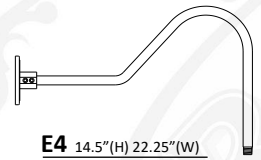

**E4** 14.5"(H) 22.25"(W)



**B1** 4"(H) 12"(W)



**E16** 4.75"(H) 8.5"(W)



**E17** 4.75"(H) 9.5"(W)



**E27** 8.875"(H) 10.5"(W)

**3/4" ARM EXTENSIONS**

\*ARMS RATED FOR WET LOCATION \* MAXIMUM SECTIONS OF ARMS ARE DIMENSIONED

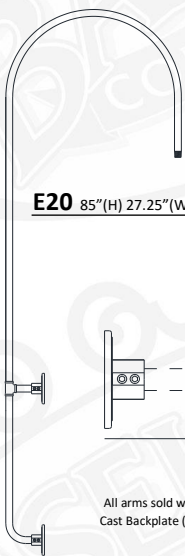

**E20** 85"(H) 27.25"(W)

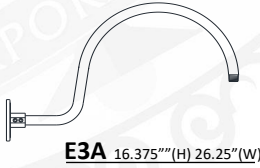

**E3A** 16.375"(H) 26.25"(W)

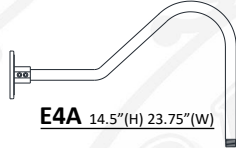

**E4A** 14.5"(H) 23.75"(W)

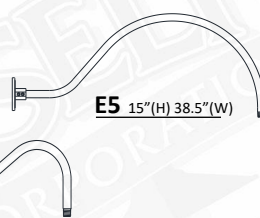

**E5** 15"(H) 38.5"(W)

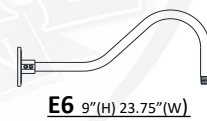

**E6** 9"(H) 23.75"(W)

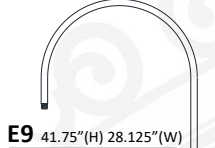

**E9** 41.75"(H) 28.125"(W)



**E12** 6(H) 39"(W)

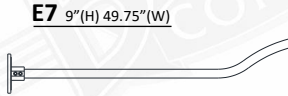

**E7** 9"(H) 49.75"(W)



**E8** 12"(H) 31.25"(W)

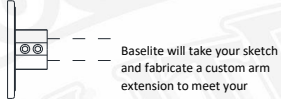

Baselite will take your sketch and fabricate a custom arm extension to meet your

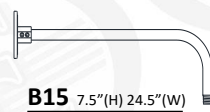

**B15** 7.5"(H) 24.5"(W)

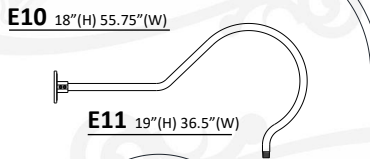

**E11** 19"(H) 36.5"(W)

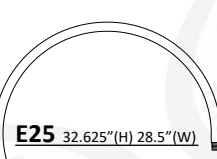

**E25** 32.625"(H) 28.5"(W)

All arms sold with Cast Backplate (CB)



**B15S** 7.5"(H) 19.5"(W)



**E21** 12.5"(H) 28.5"(W)

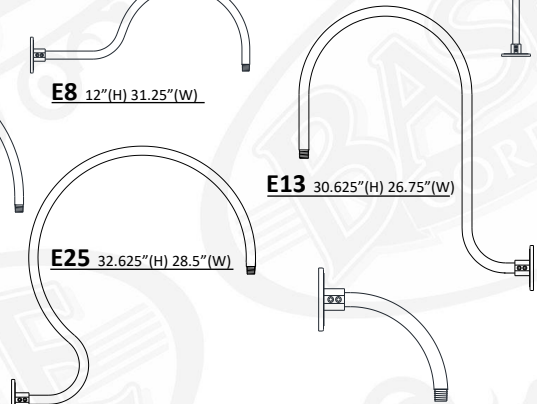

**E13** 30.625"(H) 26.75"(W)

**E19** 10.625"(H) 11.5"(W)

**E14** TBD"(H) TBD"(W)

**1/2" WALL MOUNTS**

\*MOUNTS RATED FOR WET LOCATION \* MAXIMUM SECTIONS OF MOUNTS ARE DIMENSIONED



**B10** 4.75"(H) 11"(W)



**B101** 4.75"(H) 12"(W)



**B11** 4.75"(H) 13"(W)



**B13** 4.75"(H) 15"(W)

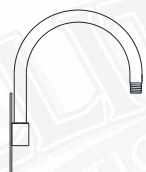

**WM13** 12"(H) 9.5"(W)

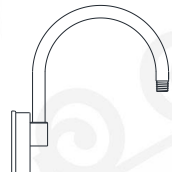

**WM13R** 12"(H) 9.5"(W)

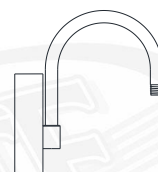

**WM13X** 12"(H) 10.5"(W)





C - MOUNTING OPTIONS (CONTINUED)

3/4" WALL MOUNTS

\*MOUNTS RATED FOR WET LOCATION \* MAXIMUM SECTIONS OF MOUNTS ARE DIMENSIONED



**B12** 6"(H) 15.5"(W)



**B9** 5"(H) 18"(W)

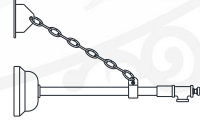

**B9C** 5"(H) 18"(W)

\*CHAIN HEIGHT TBD BY CUSTOMER

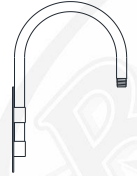

**WM14** 18"(H) 12"(W)

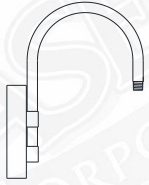

**WM14X** 18"(H) 14"(W)



**WM15** 23"(H) 19.5"(W)

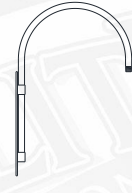

**WM18** 30"(H) 20"(W)



**WM35** 26"(H) 18.25"(W)



**WM35X** 26"(H) 22"(W)



**WM55** 19"(H) 25.5"(W)



**WM55X** 19"(H) 27"(W)



**WM60** 18"(H) 20"(W)

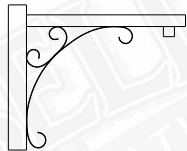

**WM60X** 18"(H) 22"(W)



**WM61** 18"(H) 20"(W)

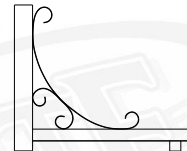

**WM61X** 18"(H) 22"(W)

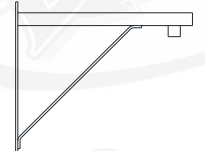

**WM70** 18"(H) 20"(W)

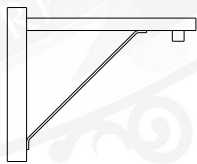

**WM70X** 18"(H) 22"(W)

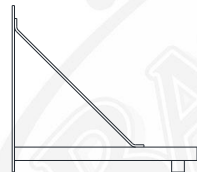

**WM71** 18"(H) 20"(W)

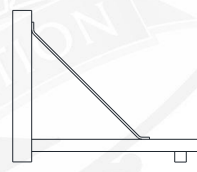

**WM71X** 18"(H) 22"(W)

STEM MOUNTS

\*STEMS RATED FOR DAMP LOCATION

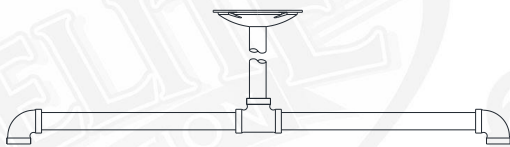

**DP24** DOUBLE PENDANT 20"(H) 24"(W)

\*DP24 COMES STANDARD WITH STC AND ST18



**ST(XX)** STEM- 1/2" NPT

XX = LENGTH OF STEM  
(EXAMPLE - "ST18" = STEM MOUNT 18" LENGTH)

\*CANOPY NOT INCLUDED, ADD IN SECTION D  
\* 1/4" NPT AND 3/4" NPT AVAILABLE UPON REQUEST



**SC24** SCROLL STEM 33"(H) 24"(W)

\*SC24 COMES STANDARD WITH STC



**C - MOUNTING OPTIONS (CONTINUED)**

**INCANDESCENT CORD MOUNTS**

\*INCANDESCENT MAX WATTAGE 150 WATT. CALL FACTORY FOR HIGHER WATTAGES. LOOPS, CABLES, AND CHAINS AVAILABLE ONLY FOR INCANDESCENT  
\*CORDS RATED FOR DRY LOCATION \*CANOPY DIMENSIONS: .625" (H) 5.25" (W) \*CORD AND CANOPY COME IN THE SAME COLOR.



**BLC** 8' BLACK CORD  
**WHC** 8' WHITE CORD



**TCB** 8' BLACK CORD, CABLE, and LOOP  
**TCW** 8' WHITE CORD, CABLE, and LOOP



**TCHB** 8' BLACK CORD, 3' CHAIN, and LOOP  
**TCHW** 8' WHITE CORD, 3' CHAIN, and LOOP



**TLB** 8' BLACK TELEPHONE CORD AND CABLE  
**TLW** 8' WHITE TELEPHONE CORD AND CABLE  
\* Not available H.I.D.



**RCB** 8' BLACK CORD, CABLE, and LOOP  
**RCW** 8' WHITE CORD, CABLE, and LOOP



**RCHB** 8' BLACK CORD, 3' CHAIN, and LOOP  
**RCHW** 8' WHITE CORD, 3' CHAIN, and LOOP

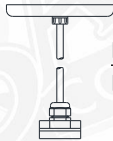

**FHB** 8' BLACK CORD WITH FLAT HUB  
**FHW** 8' WHITE CORD WITH FLAT HUB



**HBLC** 8' BLACK CORD (H.I.D.)  
**HWHC** 8' WHITE CORD (H.I.D.)  
\*(Remote ballast shades only)

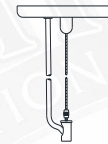

**CBLC** 8' BLACK CORD and CABLE  
**CWLC** 8' WHITE CORD and CABLE

**D - MOUNTING ADD-ONS**

**INCANDESCENT STEM AND ARM ADD-ONS**

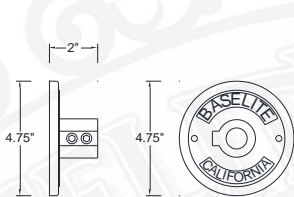

**CB 1/2"** CAST ALUMINUM BACKPLATE 1/2 NPT  
**CB 3/4"** CAST ALUMINUM BACKPLATE 3/4 NPT



**CBC 1/2"** 1/2" BACKPLATE COVER  
**CBC 3/4"** 3/4" BACKPLATE COVER  
\* Includes slip ring to hold 1/2" or 3/4" arm extension in place

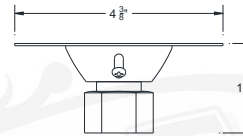

**SLC 1/2"** SLOPE CEILING CANOPY 1/2"  
**SLC 3/4"** SLOPE CEILING CANOPY 3/4"  
\*(Slopes To 20 Degrees)



**STC 1/2"** 1/2" STEM MOUNT CANOPY

**UNIVERSAL STEM AND ARM ADD-ONS**

\* EXAMPLE FOR MULTIPLE MOUNTING ADD-ONS:

MODEL #: -/-/-/ LWTM, TRB 1/2", LGSWL /-/-/-/-/-/-/-/-/-/-/



**CNK** CANOPY For MULTIPLE FIXTURES  
\*CNK dimensions vary on number of fixtures applied

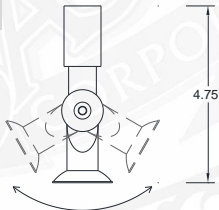

**SWL** 1/2" NPT SWIVEL  
For all arms 7" wide in diameter or smaller

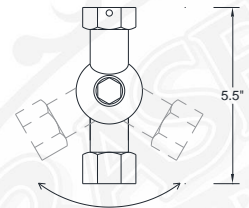

**LGSWL** 1/2" NPT SWIVEL  
For all shades greater than 7" wide in diameter

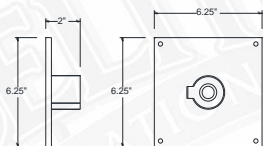

**SQ 1/2"** SQUARE BACKPLATE  
**SQ 3/4"** SQUARE BACKPLATE



**FH 1/2"** FLAT HUB 1/2"  
**FH 3/4"** FLAT HUB 3/4"

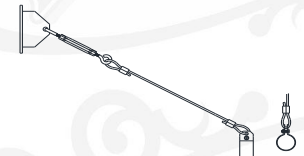

**TRB 1/2"-4' Cable** SUPPORT  
**TRB 3/4"-4' Cable** SUPPORT





**F – LIGHT SOURCE**

BASELITE'S PUBLISHED LUMINAIRE PHOTOMETRIC TESTING WAS PERFORMED IN A 3-METER INTEGRATING SPHERE USING THE 4TT GEOMETRY METHOD. DATA IS CONSIDERED TO BE REPRESENTATIVE OF THE CONFIGURATIONS SHOWN, WITHIN THE TOLERANCES ALLOWED BY LIGHTING FACTS. TO OBTAIN AN IES FILE SPECIFIC TO YOUR PROJECT, PLEASE CONTACT THE FACTORY.

INCANDESCENT (INC) <small>MED E26</small>					
<b>INC 100W- LC3</b> <b>INC 200W- LC4, LCD12</b>			<i>*IMPORTANT – FOR LIGHT EMITTED DIODE (LED) LIGHT SOURCE OPTION FIXTURES ARE LIMITED DUE TO SIZE OF THE FIXTURE AND THE CORD WATTAGE RESTRICTIONS. PLEASE SEE AVAILABILITY CHART TO THE LEFT.</i> EXAMPLE: / INC200W /		
OPTION	WATTAGE	LUMENS	CRI	VOLTAGE	DIMMING
100WINC	100W	PER BULB SPECS	>90	120-277 VAC	N/A
150WINC	150W	PER BULB SPECS	>90	120-277 VAC	N/A
200WINC	200W	PER BULB SPECS	>90	120-277 VAC	N/A

**I – GLASS OPTIONS**

\*NOTE: MUST USE TEMPERED GLASS FOR LIGHT FIXTURES USING HIGH INTENSITY DISCHARGE (HID) LIGHT SOURCE OPTION.



- CL3** 3" CLEAR GLASS
- CL4** 4" CLEAR GLASS
- CLT3** 3" CLEAR TEMPERED
- CLT4** 4" CLEAR TEMPERED



- PR3** 3" PRISMATIC GLASS
- PR4** 4" PRISMATIC GLASS



- RE3** 3" RED GLASS
- RE4** 4" RED GLASS



- BL3** 3" BLUE GLASS
- BL4** 4" BLUE GLASS



- FR3** 3" FROSTED GLASS
- FR4** 4" FROSTED GLASS
- FRT3** 3" FROSTED TEMPERED
- FRT4** 4" FROSTED TEMPERED



- AH3** 3" AMBER HYDE GLASS
- AH4** 4" AMBER HYDE GLASS



- GR3** 3" GREEN GLASS
- GR4** 4" GREEN GLASS



GLASS – MAX WATTAGE  
 3" GLASS – 100W INC / LED12W  
 4" GLASS – 200W INC / LED25W

GLASS – DIMENSIONS	
3" GLASS	Diameter 3.34"
	Height 6.93"
	Fitter 3.29"
4" GLASS	Diameter 4.34"
	Height 8.37"
	Fitter 4.29"