



BASELITE - NOVA – CF – SPECIFICATION SHEET



PROJECT NAME: _____ PROJECT TYPE: _____

MODEL #	/	/	/	/	/	/	/	/	/	/	/
EXAMPLE:	A LCD12	B 41	C E16	D SQ ½"	E 43	F 25W	G --	H LDM120	I PR3	J --	K 44

*SKIP SECTION IF OPTION DOES NOT APPLY

NOTES:



LCD12/43/BLC/PR4/150INC

A - SHADES

- NOVA**
LC3 - 32WCF (MAX)
LC4 - 42WCF (MAX)
LCD12 - 42WCF (MAX)

B - FINISH OPTIONS

(SEE WEBSITE FOR SWATCH COLORS)
 (*SEE NOTES FOR LIMITATIONS*)
 14, 15, 16, 17, 18, 19P, 20P, 20PB, 20SB,
 21P, 22P, 23P, 38, 39, 40, 41, 41.5, 42, 43,
 44, 45, 46, 48, 49, 50, 51, 52, 53, 54, 55, 57,
 58, 59, 60, 61, 62, 63, 64, 65, 66, 70, 71, 72,
 73, 74, 75, 76, 77, 78, 79, 80, 81, 82, 83, 84,
 85, 86, 87, 88, 89, 90, 91, 92, 93, 94, 95, 96,
 97, 98, 99, 100, MG.

C – MOUNTING OPTIONS

- ½" ARM EXTENSIONS**
 E1, E2, E3, E4, B1, E16, E17
¾" ARM EXTENSIONS
 E3A, E4A, E5, E6, E7, E8, E9,
 E10, E11, E12, E13, B15, B15S,
 E19, E20, E21, E25
E14 - CREATE YOUR OWN
 (BASELITE WILL TAKE YOUR SKETCH AND
 FABRICATE A CUSTOM ARM EXTENSION TO
 MEET YOUR NEEDS).
½" WALL MOUNT
 B13, WM13R, WM13X, B10, B11, B101
¾" WALL MOUNT
 B9, B9C, B12, WM10, WM11, WM14X,
 WM15, WM35X, WM55X, WM60X,
 WM61X WM70X, WM71X
COMPACT FLUORESCENT CORD MOUNT
 CFBLC, CFWHC, CFTCB, CFTCW, CFTCHB,
 CFTCHW, CFTLB, CFTLW, CFRCB, CFRCW
 CFRCHB, CFRCHW, CFFHB, CFFHW, CFHBLC,
 CFHWHC, CFCBLC, CFCWHC
STEM MOUNT
 ST6, ST12, ST18, ST24, ST36, ST48, STXX

D – MOUNTING ADD-ONS

- CF ADD-ONS**
 CFWTM, CFSLC, CFSTC
UNIVERSAL ADD-ONS
 FH ½", FH ¾", TRB ½", TRB ¾", SWL,
 LGSWL, CNK

E – MOUNTING COLOR

SEE SECTION "B" FOR COLOR OPTIONS.

F – LIGHT SOURCE

- (SEE PAGE 4 FOR WATTAGE LIMITATIONS)
COMPACT FLUORESCENT (CF)
 26W 32W 42W

G – LED COLOR TEMP

NOT AVAILABLE

H – ELECTRICAL OPTION

- (SEE PAGE 5 FOR DIMMING OPTION
 SPECIFICATIONS)
CDM120
CDM277
CDM120/277

I – GLASS OPTIONS

- CL3, CL4, CLT3, CLT4, BL3, BL4, RE3, RE4,
 GR3, GR4, AH3, AH4, FR3, FR4, FRT3, FRT4,
 PR3, PR4

J – ACCESSORIES

NOT AVAILABLE

K – ACCESSORY COLOR

SEE SECTION "B" FOR COLOR OPTIONS.

NOTES

- FINISH OPTIONS 75,76, 77, 83, 84, 88, 93 AND 98 ARE APPLIED BY HAND. THESE FINISHES WILL VARY IN CONSISTENCY.
- FINISH OPTIONS 38, 39, 40, 49, 54, 57, 58, 61, 62, 63, 70, 71, 72, 73, 78, 83, 84, 88, 92, 93, 98 ONLY AVAILABLE INSIDE AND OUT OF FIXTURE. OTHER FINISHES ARE WHITE INSIDE.
- FINISH OPTIONS FOR SHADES ≤ 10" IN DIAMETER ARE THE SAME INSIDE AND OUT OF FIXTURE. SHADES > 10" IN DIAMETER ARE WHITE ON THE INSIDE.
- FINISH OPTIONS 61, 62, 70, 71, 72, 73 ARE FINISHED WITH A SUPERCHROME ON THE INSIDE FOR ALL LED LIGHT SOURCE OPTIONS.
- COLOR CORDS ARE NOT APPLICABLE FOR LED OPTIONS.
 *ALL ARMS COME WITH A CAST BACKPLATE (CB1/2", CB3/4", LWTM, CFWTM, ECT.).
 *ACCORDING TO THE LIGHT SOURCE THE BACKPLATE MAY VARY IN SIZE. (EXAMPLE: LED LIGHT SOURCE WILL HAVE A DEEPER BACKPLATE TO HOUSE THE DRIVER.).
 *ALL FIXTURES MOUNT TO A 4-O JUNCTION BOX.
 *FIXTURE DIMENSIONS MAY VARY ± 0.25.
 *CORD AND CANOPY COME IN THE SAME COLOR.

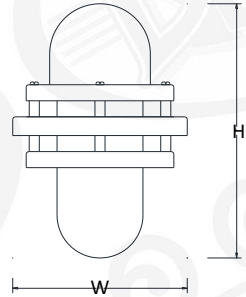

LC3 H-9.5" W-6.5"
LC4 H-13" W-8"

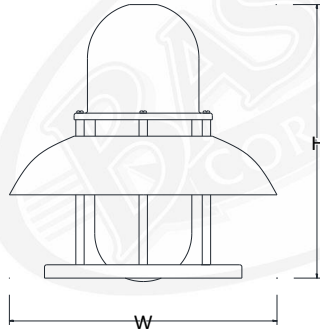

LCD12 H-10" W-12"



C - MOUNTING OPTIONS

1/2" ARM EXTENSIONS

*ARMS RATED FOR WET LOCATION * MAXIMUM SECTIONS OF ARMS ARE DIMENSIONED



E1 8.5"(H) 18.5"(W)



E2 18.5"(H) 35"(W)

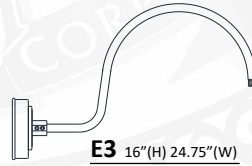

E3 16"(H) 24.75"(W)

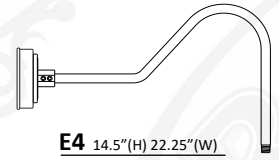

E4 14.5"(H) 22.25"(W)

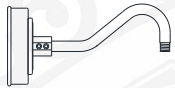

B1 4"(H) 12"(W)

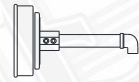

E16 4.75"(H) 8.5"(W)

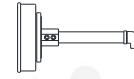

E17 4.75"(H) 9.5"(W)

3/4" ARM EXTENSIONS

*ARMS RATED FOR WET LOCATION * MAXIMUM SECTIONS OF ARMS ARE DIMENSIONED

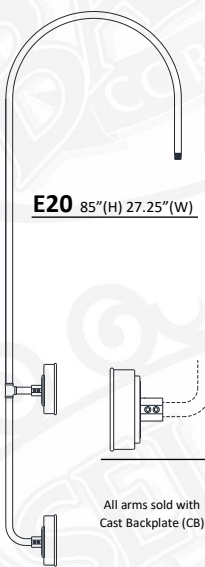

E20 85"(H) 27.25"(W)

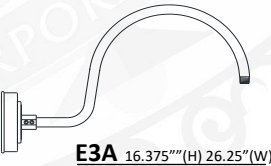

E3A 16.375"(H) 26.25"(W)

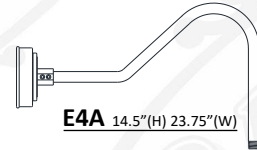

E4A 14.5"(H) 23.75"(W)

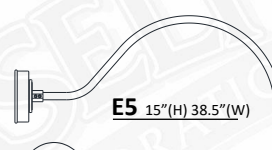

E5 15"(H) 38.5"(W)

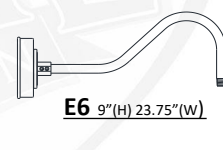

E6 9"(H) 23.75"(W)



E9 41.75"(H) 28.125"(W)

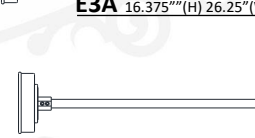

E12 6(H) 39"(W)

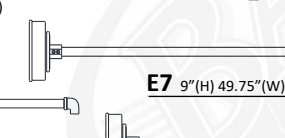

E7 9"(H) 49.75"(W)

E10 18"(H) 55.75"(W)

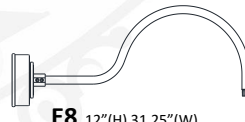

E8 12"(H) 31.25"(W)



E13 30.625"(H) 26.75"(W)

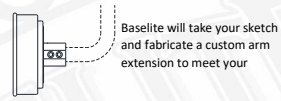

Baselite will take your sketch and fabricate a custom arm extension to meet your

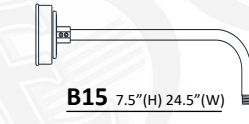

B15 7.5"(H) 24.5"(W)

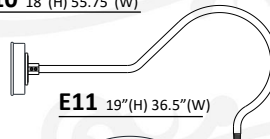

E11 19"(H) 36.5"(W)

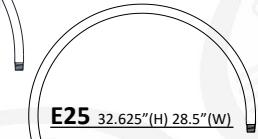

E25 32.625"(H) 28.5"(W)



All arms sold with Cast Backplate (CB)



B15S 7.5"(H) 19.5"(W)



E21 12.5"(H) 28.5"(W)



E19 10.625"(H) 11.5"(W)

1/2" WALL MOUNTS

*MOUNTS RATED FOR WET LOCATION * MAXIMUM SECTIONS OF MOUNTS ARE DIMENSIONED

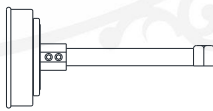

B10 6"(H) 12.5"(W)

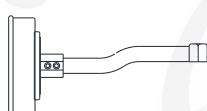

B101 6"(H) 13.5"(W)



B11 6"(H) 14.5"(W)



B13 6"(H) 16.5"(W)

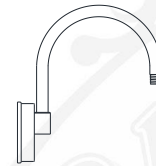

WM13R 12"(H) 9.5"(W)



WM13X 12"(H) 10.5"(W)

3/4" WALL MOUNTS

*MOUNTS RATED FOR WET LOCATION * MAXIMUM SECTIONS OF MOUNTS ARE DIMENSIONED



B12 6"(H) 15.5"(W)



B9 5"(H) 18"(W)

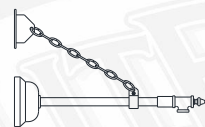

B9C 5"(H) 18"(W)

*CHAIN HEIGHT TBD BY CUSTOMER

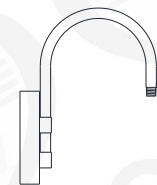

WM14X 18"(H) 14"(W)



WM15 23"(H) 19.5"(W)



C - MOUNTING OPTIONS (CONTINUED)

3/4" WALL MOUNTS

*MOUNTS RATED FOR WET LOCATION * MAXIMUM SECTIONS OF MOUNTS ARE DIMENSIONED



WM35X 26"(H) 22"(W)



WM55X 19"(H) 27"(W)

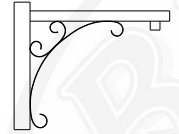

WM60X 18"(H) 22"(W)

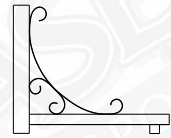

WM61X 18"(H) 22"(W)

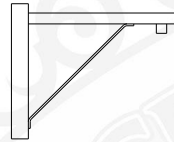

WM70X 18"(H) 22"(W)

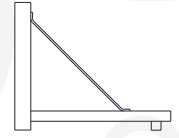

WM71X 18"(H) 22"(W)

STEM MOUNTS

*STEMS RATED FOR DAMP LOCATION

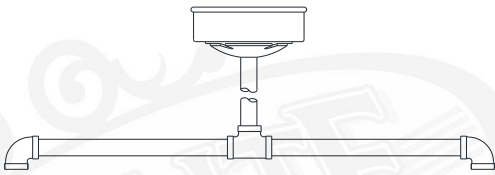

DP24 DOUBLE PENDANT 20"(H) 24"(W)

*DP24 COMES STANDARD WITH CFSTC AND ST18



ST(XX) STEM- 1/2" NPT

XX = LENGTH OF STEM
(EXAMPLE - "ST18" = STEM MOUNT 18" LENGTH)
*CANOPY NOT INCLUDED, ADD IN SECTION D
* 1/4" NPT AND 3/4" NPT AVAILABLE UPON REQUEST



SC24 SCROLL STEM 33"(H) 26"(W)

*SC24 COMES STANDARD WITH CFSTC

COMPACT FLUORESCENT CORD MOUNTS

*FOR LED & COMPACT FLUORESCENT OPTIONS, CANOPIES WILL VARY IN SIZE DUE TO SIZE OF THE DRIVER/BALLAST THAT WILL BE LOCATED INSIDE OF THE CANOPY.
*CORDS RATED FOR DRY LOCATION *CANOPY DIMENSIONS: 4" (H) 5.5" (W) *CORD AND CANOPY COME IN THE SAME COLOR.



CFBLC 8' BLACK CORD
CFWHC 8' WHITE CORD



CFTCB 8' BLACK CORD, CABLE, and LOOP
CFTCW 8' WHITE CORD, CABLE, and LOOP



CFTCHB 8' BLACK CORD, 3' CHAIN, and LOOP
CFTCHW 8' WHITE CORD, 3' CHAIN, and LOOP



CFRCB 8' BLACK CORD, CABLE, and LOOP
CFRCW 8' WHITE CORD, CABLE, and LOOP



CFRCHB 8' BLACK CORD, 3' CHAIN, and LOOP
CFRCHW 8' WHITE CORD, 3' CHAIN, and LOOP



CFFHB 8' BLACK CORD WITH FLAT HUB
CFFHW 8' WHITE CORD WITH FLAT HUB



CFCBLC 8' BLACK CORD and CABLE
CFCWHC 8' WHITE CORD and CABLE

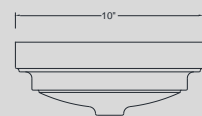

NOTES:
*DISTANCE TO LAMP (CF) 10"
*All compact fluorescent and LED housings may vary in size according to light source chosen.



D - MOUNTING ADD-ONS

COMPACT FLUORESCENT STEM AND ARM ADD-ONS

* FOR LED & COMPACT FLUORESCENT OPTIONS, CANOPIES WILL VARY IN SIZE DUE TO SIZE OF THE DRIVER/BALLAST THAT WILL BE LOCATED INSIDE OF THE CANOPY.

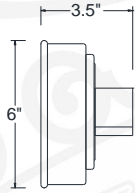

CFWTM WEATHERTIGHT CF WALL MOUNT

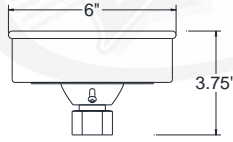

CFSLC CF SLOPE CEILING CANOPY

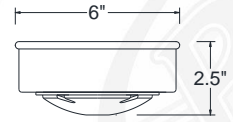

CFSTC CF STEM MOUNT CANOPY

UNIVERSAL STEM AND ARM ADD-ONS

* EXAMPLE FOR MULTIPLE MOUNTING ADD-ONS:

MODEL #:

-	-	-	-	W	T	M	,	T	R	B	1/2"	,	L	G	S	W	/	-	-	-	-	-	-
A	B	C		D				E	F	G	H	I	J	K									

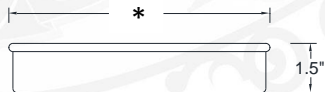

CNK CANOPY For MULTIPLE FIXTURES

*CNK dimensions vary on number of fixtures applied

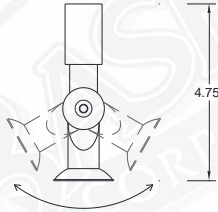

SWL 1/2" NPT SWIVEL

For all arms 7" wide in diameter or smaller

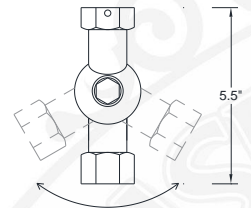

LSWL 1/2" NPT SWIVEL

For all shades greater than 7" wide in diameter



FH 1/2" FLAT HUB 1/2"

FH 3/4" FLAT HUB 3/4"

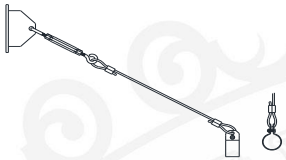

TRB 1/2"-4' Cable SUPPORT

TRB 3/4"-4' Cable SUPPORT

F – LIGHT SOURCE

BASELITE’S PUBLISHED LUMINAIRE PHOTOMETRIC TESTING WAS PERFORMED IN A 3-METER INTEGRATING SPHERE USING THE 4TT GEOMETRY METHOD. DATA IS CONSIDERED TO BE REPRESENTATIVE OF THE CONFIGURATIONS SHOWN, WITHIN THE TOLERANCES ALLOWED BY LIGHTING FACTS. TO OBTAIN AN IES FILE SPECIFIC TO YOUR PROJECT, PLEASE CONTACT THE FACTORY.

COMPACT FLUORESCENT (CF)					
CF 26W, 32W(MAX)- LC3 CF 26W, 32W, OR 42(MAX)- LC4, LCD12			*IMPORTANT – FOR COMPACT FLUORESCENT (CF) LIGHT SOURCE, FIXTURES ARE LIMITED DUE TO THE SIZE OF THE SHADE. PLEASE SEE THE CHART TO THE LEFT TO SEE WHAT WATTAGE IS COMPARABLE FOR EACH FIXTURE WHEN ORDERING.		
EXAMPLE: / CF42W /					
OPTION	WATTAGE	LUMENS	CRI	VOLTAGE	DIMMING
CF26W	26W	PER BULB SPECS	>90	120-277 VAC	See section "H"
CF32W	32W	PER BULB SPECS	>90	120-277 VAC	See section "H"
CF42W	42W	PER BULB SPECS	>90	120-277 VAC	See section "H"



H – ELECTRICAL OPTION

MOST BASELITE'S ELECTRICAL OPTIONS ARE ONLY COMPATIBLE FOR CERTAIN FIXTURES. PLEASE SEE NOTES BELOW AND FOR FURTHER DEATIALS CONTACT THE FACTORY. FOR DIMMING BALLAST OPTION PLEASE CHOOSE MARK X OR MARK VII, SO RESTRICTIONS APPLY DUE TO THE SIZE OF THE BALLAST AND FIXTURE.

COMPACT FLUORESCENT DIMMING OPTIONS

PROVIDED WITH ADVANCE TRANSFORMER, PLEASE CHOOSE MARK 10 OR MARK 7 WITH SPECIFIED VOLTAGE FROM THE LIST BELOW. CONTACT BALLAST MANUFACTURER FOR SPECIFICATIONS.

CDM7-120/277 - ADVANCE MARK 7 0-10v ELECTRICAL BALLST – 120/277 VOLT

CDM10-120 - ADVANCE MARK 10 ELECTRICAL BALLST – 120 VOLT

CDM10-277 - ADVANCE MARK 10 ELECTRICAL BALLST – 277 VOLT

I – GLASS OPTIONS

*NOTE: MUST USE TEMPERED GLASS FOR LIGHT FIXTURES USING HIGH INTENSITY DISCHARGE (HID) LIGHT SOURCE OPTION.



- CL3** 3" CLEAR GLASS
- CL4** 4" CLEAR GLASS
- CLT3** 3" CLEAR TEMPERED
- CLT4** 4" CLEAR TEMPERED



- PR3** 3" PRISMATIC GLASS
- PR4** 4" PRISMATIC GLASS



- RE3** 3" RED GLASS
- RE4** 4" RED GLASS



- BL3** 3" BLUE GLASS
- BL4** 4" BLUE GLASS



- FR3** 3" FROSTED GLASS
- FR4** 4" FROSTED GLASS
- FRT3** 3" FROSTED TEMPERED
- FRT4** 4" FROSTED TEMPERED



- AH3** 3" AMBER HYDE GLASS
- AH4** 4" AMBER HYDE GLASS



- GR3** 3" GREEN GLASS
- GR4** 4" GREEN GLASS

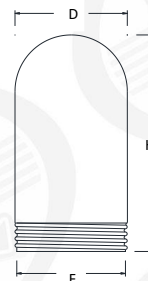

GLASS – MAX WATTAGE	
3" GLASS – 100W INC / LED12W	
4" GLASS – 200W INC / LED25W	

GLASS – DIMENSIONS	
3" GLASS	
Diameter	3.34"
Height	6.93"
Fitter	3.29"
4" GLASS	
Diameter	4.34"
Height	8.37"
Fitter	4.29"