



BASELITE – ELLIPTICAL SHADE – INC – SPEC SHEET



PROJECT NAME: _____ PROJECT TYPE: _____

MODEL #	/	/	/	/	/	/	/	/	/	/	/
EXAMPLE:	A ELA12	B 41	C E16	D CB ½"	E 43	F 25W	G 3K	H LDM120	I PR3	J GU-2	K 44

*SKIP SECTION IF OPTION DOES NOT APPLY

NOTES:



ELA12/43/E3A/CB½"/43/150INC

A - SHADES

ELLIPTICAL SHADE SERIES

- ELA10 - 100WINC (MAX)
- ELA12 - 150WINC (MAX)
- ELA14 - 200WINC (MAX)

B - FINISH OPTIONS

(*SEE NOTES FOR LIMITATIONS*)
 (SEE WEBSITE FOR SWATCH COLORS)
 38, 40, 41, 42, 43, 44, 45, 46, 48, 49,
 50, 51, 52, 53, 54, 55, 59, 60, 61, 62,
 63, 74, 81, 87, 97

C – MOUNTING OPTIONS

½" ARM EXTENSIONS

- E1, E2, E2S, E3, E4, B1, E16,
E17, E18A, E22, E23, E24

¾" ARM EXTENSIONS

- E3A, E4A, E5, E6, E7, E8, E9,
E10, E11, E12, E13, B15,
E19, E20, E21, E25

E14 - CREATE YOUR OWN

(BASELITE WILL TAKE YOUR SKETCH
 AND FABRICATE A CUSTOM ARM
 EXTENSION TO MEET YOUR NEEDS).

CORD MOUNT

- BLC, WHC, TCB, TCW, TCHB, TCHW, TLB,
TLW, TLB, TLW, RCB, RCW, RCHB, RCHW,
FHB, FHW, HBLC, HWHC, CBLC, CWHC

STEM MOUNT

- DP24, ST6, ST12, ST18, ST24, ST36,
ST48, STXX

D – MOUNTING ADD-ONS

INC ADD-ONS

- CB1/2", CB3/4", CBC1/2", CBC3/4",
SLC1/2", SLC3/4", STC1/2"

UNIVERSAL ADD-ONS

- FH ½", FH ¾", TRB ½", TRB ¾",
LGSWL, SMSWL

E – MOUNTING COLOR

SEE SECTION "B" FOR COLOR OPTIONS.

F – LIGHT SOURCE

(SEE PAGE 4 FOR WATTAGE LIMITATIONS)

INCANDESCENT (INC)

- 100W, 150W, 200W

G – LED COLOR TEMP

NOT AVAILABLE

H – ELECTRICAL OPTION

NOT AVAILABLE

I – GLASS OPTIONS

- CL3, CL4, CLT3, CLT4, BL3, BL4, RE3, RE4,
GR3, GR4, AH3, AH4, FR3, FR4, FRT3, FRT4,
PR3, PR4

J – ACCESSORIES

- GU-1, GU-2

K – ACCESSORY COLOR

SEE SECTION "B" FOR COLOR OPTIONS.

NOTES

- (1). FINISH OPTIONS 38, 40, 49, 54, 61, 62, 63 ONLY AVAILABLE INSIDE AND OUT OF FIXTURE. OTHER FINISHES ARE WHITE INSIDE.
 - (2). FINISH OPTIONS FOR SHADES ≤ 10" IN DIAMETER ARE THE SAME INSIDE AND OUT OF FIXTURE. SHADES > 10" IN DIAMETER ARE WHITE ON THE INSIDE.
 - (3). FINISH OPTIONS 61 AND 62 ARE FINISHED WITH A SUPERCHROME ON THE INSIDE FOR ALL LED LIGHT SOURCE OPTIONS.
 - (4). COLOR CORDS ARE NOT APPLICABLE FOR LED OPTIONS.
- *ALL ARMS COME WITH A CAST BACKPLATE (CB1/2", CB3/4", LWTM, CFWTM, ECT.).
- *ACCORDING TO THE LIGHT SOURCE THE BACKPLATE MAY VARY IN SIZE. (EXAMPLE: LED LIGHT SOURCE WILL HAVE A DEEPER BACKPLATE TO HOUSE THE DRIVER.).
- *ALL FIXTURES MOUNT TO A 4-O JUNCTION BOX.
- *FIXTURE DIMENSIONS MAY VARY ± 0.25.
- *CORD AND CANOPY COME IN THE SAME COLOR.

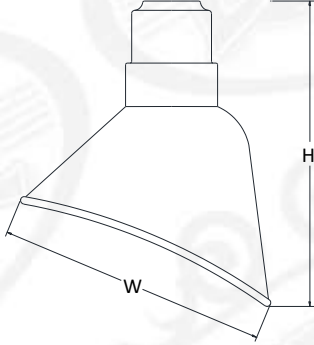

ELA10	H - 10.75"	W - 9"
ELA12	H - 12.25"	W - 11"
ELA14	H - 14"	W - 13"



C - MOUNTING OPTIONS

1/2" ARM EXTENSIONS

* ARMS RATED FOR WET LOCATION * MAXIMUM SECTIONS OF ARMS ARE DIMENSIONED

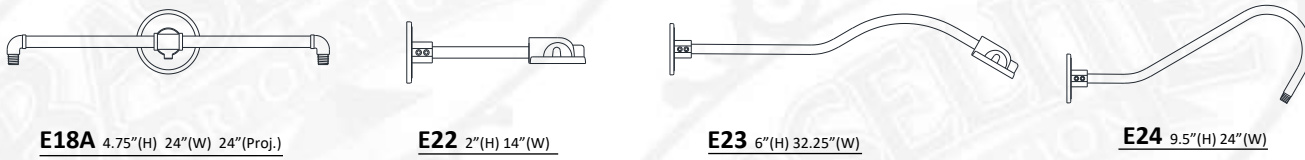

3/4" ARM EXTENSIONS

* ARMS RATED FOR WET LOCATION * MAXIMUM SECTIONS OF ARMS ARE DIMENSIONED

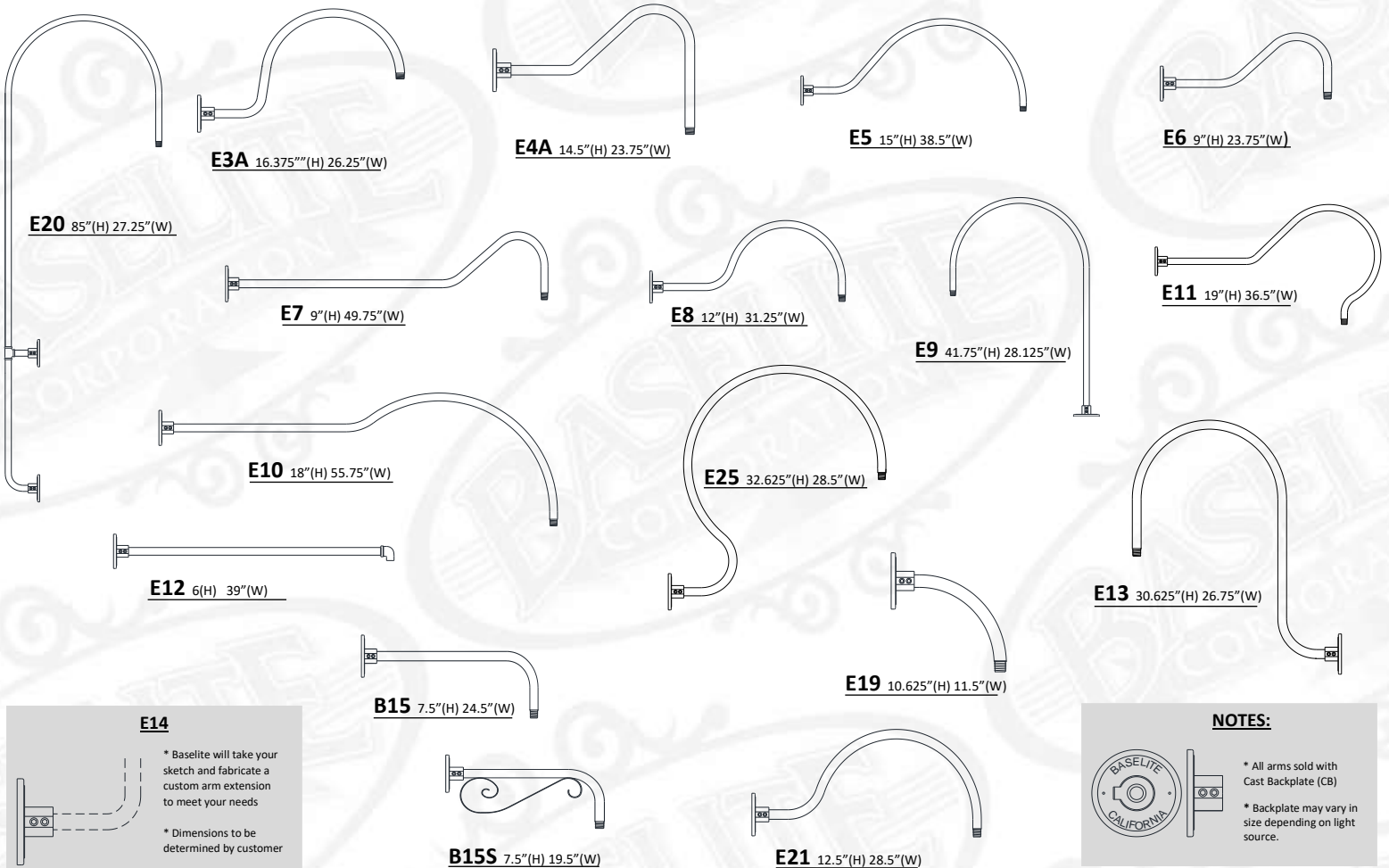

E14

* Baselite will take your sketch and fabricate a custom arm extension to meet your needs

* Dimensions to be determined by customer

NOTES:



* All arms sold with Cast Backplate (CB)

* Backplate may vary in size depending on light source.



C - MOUNTING OPTIONS (CONTINUED)

STEM MOUNTS

*STEMS RATED FOR DAMP LOCATION

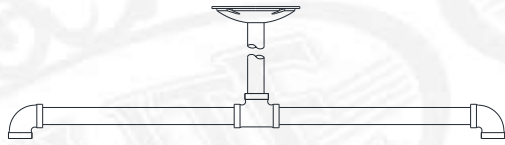

DP24 DOUBLE PENDANT 20"(H) 24"(W)
*DP24 COMES STANDARD WITH STC AND ST18



ST(XX) STEM- 1/2" NPT

XX = LENGTH OF STEM
(EXAMPLE - "ST18" = STEM MOUNT 18" LENGTH)
*CANOPY NOT INCLUDED, ADD IN SECTION D
* 1/4" NPT AND 3/4" NPT AVAILABLE UPON REQUEST

INCANDESCENT CORD MOUNTS

*INCANDESCENT MAX WATTAGE 150 WATT. CALL FACTORY FOR HIGHER WATTAGES. LOOPS, CABLES, AND CHAINS AVAILABLE ONLY FOR INCANDESCENT
*CORDS RATED FOR DRY LOCATION *CANOPY DIMENSIONS: .625" (H) 5.25" (W) *CORD AND CANOPY COME IN THE SAME COLOR.



BLC 8' BLACK CORD
WHC 8' WHITE CORD

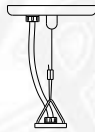

TCB 8' BLACK CORD, CABLE, and LOOP
TCW 8' WHITE CORD, CABLE, and LOOP



TCHB 8' BLACK CORD, 3" CHAIN, and LOOP
TCHW 8' WHITE CORD, 3" CHAIN, and LOOP



TLB 8' BLACK TELEPHONE CORD AND CABLE
TLW 8' WHITE TELEPHONE CORD AND CABLE
* Not available H.I.D.

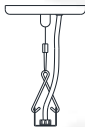

RCB 8' BLACK CORD, CABLE, and LOOP
RCW 8' WHITE CORD, CABLE, and LOOP



RCHB 8' BLACK CORD, 3" CHAIN, and LOOP
RCHW 8' WHITE CORD, 3" CHAIN, and LOOP

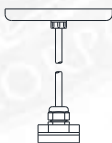

FHB 8' BLACK CORD WITH FLAT HUB
FHW 8' WHITE CORD WITH FLAT HUB



HBLC 8' BLACK CORD (H.I.D.)
HWHC 8' WHITE CORD (H.I.D.)
*(Remote ballast shades only)



CBLC 8' BLACK CORD and CABLE
CWLC 8' WHITE CORD and CABLE

D - MOUNTING ADD-ONS

INCANDESCENT ARM ADD-ONS

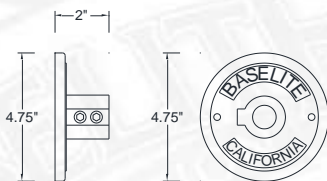

CB 1/2" CAST ALUMINUM BACKPLATE 1/2 NPT
CB 3/4" CAST ALUMINUM BACKPLATE 3/4 NPT

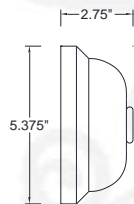

CBC 1/2" 1/2" BACKPLATE COVER
CBC 3/4" 3/4" BACKPLATE COVER
* Includes slip ring to hold 1/2" or 3/4" arm extension in place

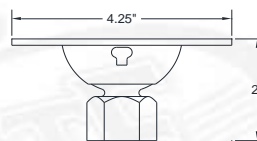

SLC 1/2" SLOPE CEILING CANOPY 1/2"
SLC 3/4" SLOPE CEILING CANOPY 3/4"
*(Slopes To 20 Degrees)

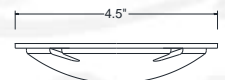

STC 1/2" 1/2" STEM MOUNT CANOPY



D - MOUNTING ADD-ONS (CONTINUED)

UNIVERSAL STEM AND ARM ADD-ONS

* EXAMPLE FOR MULTIPLE MOUNTING ADD-ONS:

MODEL #: -/-/LWTM, TRB 1/2", LGSWL -/-/-/-/

A B C D E F G H I J K

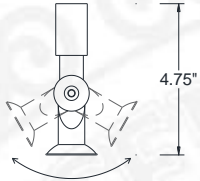

SWL 1/2" NPT swivel
For all arms 7" wide in diameter or smaller

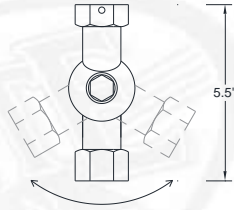

LGSWL 1/2" NPT SWIVEL
For all shades greater than 7" wide in diameter

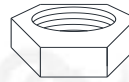

FH 1/2" FLAT HUB 1/2"
FH 3/4" FLAT HUB 3/4"



TRB 1/2"-4' Cable SUPPORT
TRB 3/4"-4' Cable SUPPORT

F – LIGHT SOURCE

BASELITE'S PUBLISHED LUMINAIRE PHOTOMETRIC TESTING WAS PERFORMED IN A 3-METER INTEGRATING SPHERE USING THE 4TT GEOMETRY METHOD. DATA IS CONSIDERED TO BE REPRESENTATIVE OF THE CONFIGURATIONS SHOWN, WITHIN THE TOLERANCES ALLOWED BY LIGHTING FACTS. TO OBTAIN AN IES FILE SPECIFIC TO YOUR PROJECT, PLEASE CONTACT THE FACTORY.

INCANDESCENT (INC) MED E26

- INC 100W** - ELA10
- INC 150W** - ELA12
- INC 200W** - ELA14

***IMPORTANT – FOR INCANDESCENT (INC) LIGHT SOURCE OPTION, FIXTURES ARE LIMITED DUE TO SIZE OF THE FIXTURE AND THE CORD WATTAGE RESTRICTIONS. PLEASE SEE AVAILABILITY CHART TO THE LEFT.**

EXAMPLE: / INC100W /

OPTION	WATTAGE	LUMENS	CRI	VOLTAGE	DIMMING
100WINC	100W	PER BULB SPECS	>90	120-277 VAC	N/A
150WINC	150W	PER BULB SPECS	>90	120-277 VAC	N/A
200WINC	200W	PER BULB SPECS	>90	120-277 VAC	N/A



I – GLASS OPTIONS

*NOTE: MUST USE TEMPERED GLASS FOR LIGHT FIXTURES USING HIGH INTENSITY DISCHARGE (HID) LIGHT SOURCE OPTION.



CL3 3" CLEAR GLASS
CLT3 3" CLEAR TEMPERED



PR3 3" PRISMATIC GLASS



RE3 3" RED GLASS



BL3 3" BLUE GLASS



FR3 3" FROSTED GLASS
FRT3 3" FROSTED TEMPERED



AH3 3" AMBER HYDE GLASS



GR3 3" GREEN GLASS

GLASS – DIMENSIONS	
3" GLASS	
Diameter	3.34"
Height	6.93"
Fitter	3.29"

GLASS – MAX WATTAGE	
3" GLASS – 100W INC / LED12W	

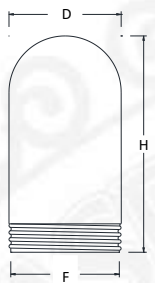

J – ACCESSORIES

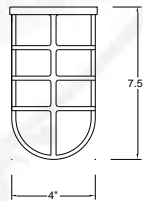

GU-1 CAST ALUMINUM GUARD

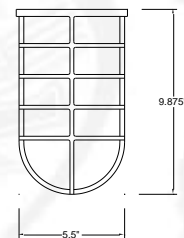

GU-2 CAST ALUMINUM GUARD