



BASELITE – ELLIPTICAL SHADE – CF – SPEC SHEET



PROJECT NAME: _____ PROJECT TYPE: _____

MODEL #	/	/	/	/	/	/	/	/	/	/	/
EXAMPLE:	A ELA12	B 41	C E16	D CB ½"	E 43	F 25W	G 3K	H LDM120	I PR3	J GU-2	K 44

*SKIP SECTION IF OPTION DOES NOT APPLY

NOTES:



ELA12/43/E3A/CB½"/43/150INC

A - SHADES

ELLIPTICAL SHADE SERIES

- ELA10 - 26WCF (MAX)
- ELA12 - 42WCF (MAX)
- ELA14 - 42WCF (MAX)

B - FINISH OPTIONS

(*SEE NOTES FOR LIMITATIONS*)
 (SEE WEBSITE FOR SWATCH COLORS)
 38, 40, 41, 42, 43, 44, 45, 46, 48, 49,
 50, 51, 52, 53, 54, 55, 59, 60, 61, 62,
 63, 74, 81, 87, 97

C – MOUNTING OPTIONS

½" ARM EXTENSIONS

- E1, E2, E2S, E3, E4, B1, E16,
E17, E18A, E22, E23, E24

¾" ARM EXTENSIONS

- E3A, E4A, E5, E6, E7, E8, E9,
E10, E11, E12, E13, B15,
E19, E20, E21, E25

E14 - CREATE YOUR OWN

(BASELITE WILL TAKE YOUR SKETCH
 AND FABRICATE A CUSTOM ARM
 EXTENSION TO MEET YOUR NEEDS).

COMPACT FLUORESCENT CORD MOUNT

- CFBLC, CFWHC, CFTCB, CFTCW,
CFTCHB, CFTCHW, CFTLB, CFTLW,
CFRCB, CFRCW, CFRCHB, CFRCHW,
CFFHB, CFFHW, CFHBL, CFHWHC,
CFCBLC, CFCWHC

STEM MOUNT

- DP24, ST6, ST12, ST18, ST24, ST36,
ST48, STXX

D – MOUNTING ADD-ONS

CF ADD-ONS

CFWTM, CFSLC, CFSTC

UNIVERSAL ADD-ONS

FH ½", FH ¾", TRB ½", TRB ¾",
LGSWL, SMSWL

E – MOUNTING COLOR

SEE SECTION "B" FOR COLOR OPTIONS.

F – LIGHT SOURCE

(SEE PAGE 4 FOR WATTAGE LIMITATIONS)

COMPACT FLUORESCENT (CF)

26W, 32W, 42W

G – LED COLOR TEMP

NOT AVAILABLE

H – ELECTRICAL OPTION

(SEE PAGE 4 FOR DIMMING OPTION SPECIFICATIONS)

CDM120

CDM277

CDM120/277

I – GLASS OPTIONS

CL3, CL4, CLT3, CLT4, BL3, BL4, RE3, RE4,
GR3, GR4, AH3, AH4, FR3, FR4, FRT3, FRT4,
PR3, PR4

J – ACCESSORIES

GU-1, GU-2

K – ACCESSORY COLOR

SEE SECTION "B" FOR COLOR
 OPTIONS.

NOTES

- FINISH OPTIONS 38, 40, 49, 54, 61, 62, 63 ONLY AVAILABLE INSIDE AND OUT OF FIXTURE. OTHER FINISHES ARE WHITE INSIDE.
 - FINISH OPTIONS FOR SHADES ≤ 10" IN DIAMETER ARE THE SAME INSIDE AND OUT OF FIXTURE. SHADES > 10" IN DIAMETER ARE WHITE ON THE INSIDE.
 - FINISH OPTIONS 61 AND 62 ARE FINISHED WITH A SUPERCHROME ON THE INSIDE FOR ALL LED LIGHT SOURCE OPTIONS.
 - COLOR CORDS ARE NOT APPLICABLE FOR LED OPTIONS.
- *ALL ARMS COME WITH A CAST BACKPLATE (CB1/2", CB3/4", LWTM, CFWTM, ECT.).
- *ACCORDING TO THE LIGHT SOURCE THE BACKPLATE MAY VARY IN SIZE. (EXAMPLE: LED LIGHT SOURCE WILL HAVE A DEEPER BACKPLATE TO HOUSE THE DRIVER.).
- *ALL FIXTURES MOUNT TO A 4-O JUNCTION BOX.
- *FIXTURE DIMENSIONS MAY VARY ± 0.25.
- *CORD AND CANOPY COME IN THE SAME COLOR.

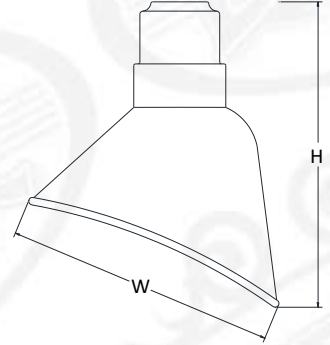

ELA10 H - 10.75" W - 9"

ELA12 H - 12.25" W - 11"

ELA14 H - 14" W - 13"



C - MOUNTING OPTIONS

1/2" ARM EXTENSIONS

*ARMS RATED FOR WET LOCATION * MAXIMUM SECTIONS OF ARMS ARE DIMENSIONED

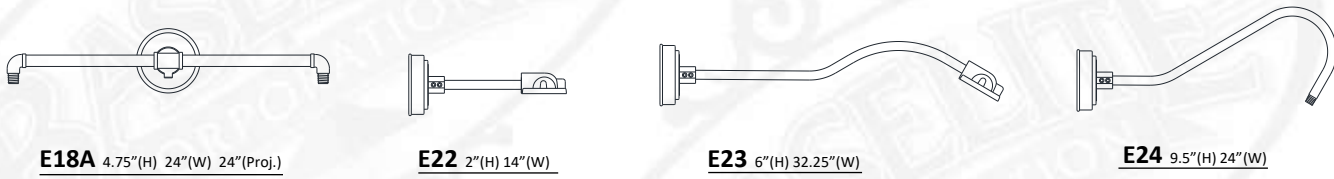
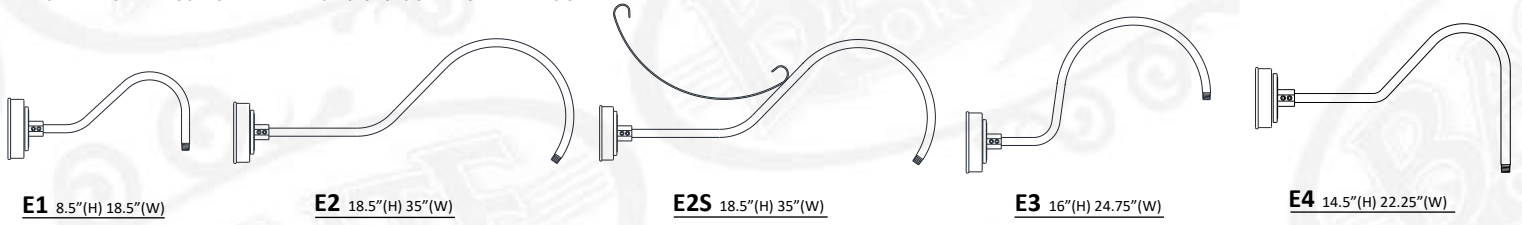

3/4" ARM EXTENSIONS

*ARMS RATED FOR WET LOCATION * MAXIMUM SECTIONS OF ARMS ARE DIMENSIONED

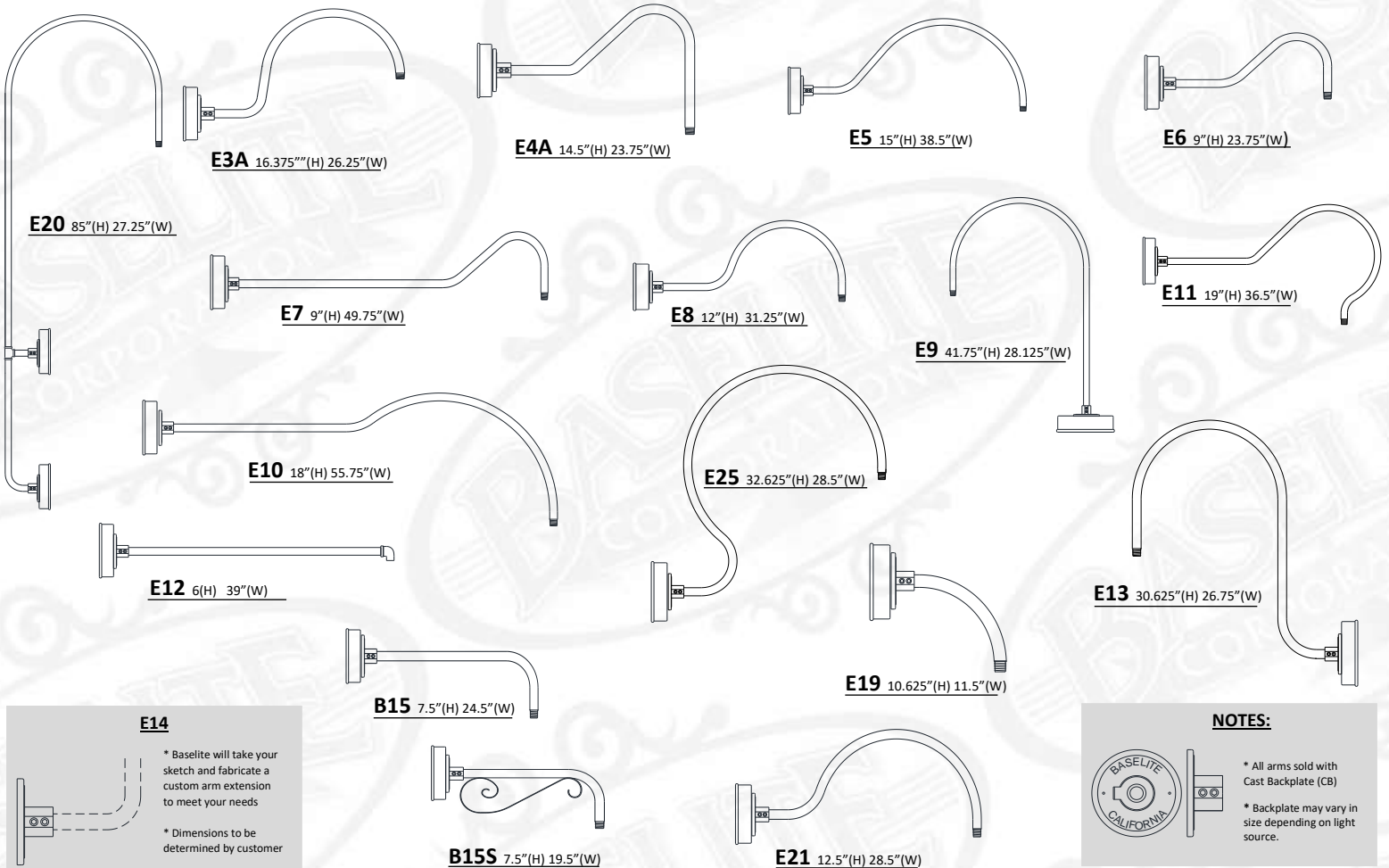

NOTES:



* All arms sold with Cast Backplate (CB)
* Backplate may vary in size depending on light source.



C - MOUNTING OPTIONS (CONTINUED)

STEM MOUNTS

*STEMS RATED FOR DAMP LOCATION

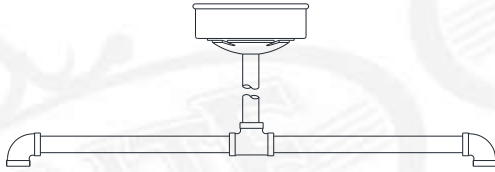

DP24 DOUBLE PENDANT 20"(H) 24"(W)
*DP24 COMES STANDARD WITH CFSTC AND ST18



ST(XX) STEM- 1/2" NPT

XX = LENGTH OF STEM
(EXAMPLE - "ST18" = STEM MOUNT 18" LENGTH)
*CANOPY NOT INCLUDED, ADD IN SECTION D
* 1/4" NPT AND 3/4" NPT AVAILABLE UPON REQUEST

COMPACT FLUORESCENT CORD MOUNTS

*FOR LED & COMPACT FLUORESCENT OPTIONS, CANOPIES WILL VARY IN SIZE DUE TO SIZE OF THE DRIVER/BALLAST THAT WILL BE LOCATED INSIDE OF THE CANOPY.
*CORDS RATED FOR DRY LOCATION *CANOPY DIMENSIONS: 3" (H) 6" (W) *CORD AND CANOPY COME IN THE SAME COLOR.



CFBC 8' BLACK CORD
CFWHC 8' WHITE CORD

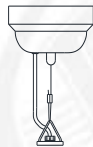

CFTCB 8' BLACK CORD, CABLE, and LOOP
CFTCW 8' WHITE CORD, CABLE, and LOOP



CFTCHB 8' BLACK CORD, 3" CHAIN, and LOOP
CFTCHW 8' WHITE CORD, 3" CHAIN, and LOOP

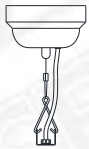

CFRCB 8' BLACK CORD, CABLE, and LOOP
CFRCW 8' WHITE CORD, CABLE, and LOOP



CFRCHB 8' BLACK CORD, 3" CHAIN, and LOOP
CFRCHW 8' WHITE CORD, 3" CHAIN, and LOOP



CFFHB 8' BLACK CORD WITH FLAT HUB
CFFHW 8' WHITE CORD WITH FLAT HUB



CFCBLC 8' BLACK CORD and CABLE
CFCWHC 8' WHITE CORD and CABLE

NOTES:

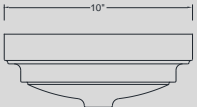

*DISTANCE TO LAMP (CF) 10'

*All compact fluorescent and LED housings may vary in size according to light source chosen.

D - MOUNTING ADD-ONS

COMPACT FLUORESCENT STEM AND ARM ADD-ONS

* FOR LED & COMPACT FLUORESCENT OPTIONS, CANOPIES WILL VARY IN SIZE DUE TO SIZE OF THE DRIVER/BALLAST THAT WILL BE LOCATED INSIDE OF THE CANOPY.

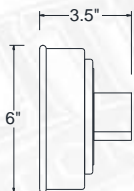

CFWTM WEATHERTIGHT CF WALL MOUNT

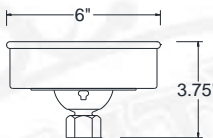

CFSLC CF SLOPE CEILING CANOPY

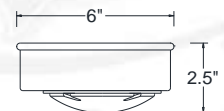

CFSTC CF STEM MOUNT CANOPY



D - MOUNTING ADD-ONS (CONTINUED)

UNIVERSAL STEM AND ARM ADD-ONS

* EXAMPLE FOR MULTIPLE MOUNTING ADD-ONS:

MODEL #: -/-/LWTM, TRB 1/2", LGSWL -/-/-/-/

A B C D E F G H I J K

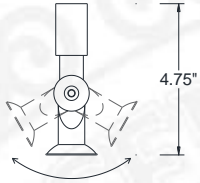

SWL 1/2" NPT swivel
For all arms 7" wide in diameter or smaller

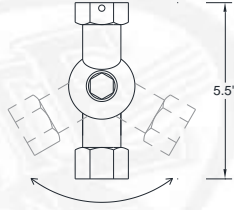

LGSWL 1/2" NPT SWIVEL
For all shades greater than 7" wide in diameter

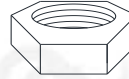

FH 1/2" FLAT HUB 1/2"
FH 3/4" FLAT HUB 3/4"



TRB 1/2"-4' Cable SUPPORT
TRB 3/4"-4' Cable SUPPORT

F – LIGHT SOURCE

BASELITE'S PUBLISHED LUMINAIRE PHOTOMETRIC TESTING WAS PERFORMED IN A 3-METER INTEGRATING SPHERE USING THE 4TT GEOMETRY METHOD. DATA IS CONSIDERED TO BE REPRESENTATIVE OF THE CONFIGURATIONS SHOWN, WITHIN THE TOLERANCES ALLOWED BY LIGHTING FACTS. TO OBTAIN AN IES FILE SPECIFIC TO YOUR PROJECT, PLEASE CONTACT THE FACTORY.

COMPACT FLUORESCENT (CF)

CF 26W (MAX) - ELA10
CF 26W, 32W, OR 42(MAX) - ELA12, ELA14

***IMPORTANT – FOR COMPACT FLUORESCENT (CF) LIGHT SOURCE, FIXTURES ARE LIMITED DUE TO THE SIZE OF THE SHADE. PLEASE SEE THE CHART TO THE LEFT TO SEE WHAT WATTAGE IS COMPARABLE FOR EACH FIXTURE WHEN ORDERING.**

EXAMPLE: / CF42W /

OPTION	WATTAGE	LUMENS	CRI	VOLTAGE	DIMMING
CF26W	26W	PER BULB SPECS	>90	120-277 VAC	See section "H"
CF32W	32W	PER BULB SPECS	>90	120-277 VAC	See section "H"
CF42W	42W	PER BULB SPECS	>90	120-277 VAC	See section "H"

H – ELECTRICAL OPTION

MOST BASELITE'S ELECTRICAL OPTIONS ARE ONLY COMPATIBLE FOR CERTAIN FIXTURES. PLEASE SEE NOTES BELOW AND FOR FURTHER DEATIALS CONTACT THE FACTORY. FOR DIMMING BALLAST OPTION PLEASE CHOOSE MARK X OR MARK VII, SO RESTRICTIONS APPLY DUE TO THE SIZE OF THE BALLAST AND FIXTURE.

COMPACT FLUORESCENT DIMMING OPTIONS

PROVIDED WITH ADVANCE TRANSFORMER, PLEASE CHOOSE MARK 10 OR MARK 7 WITH SPECIFIED VOLTAGE FROM THE LIST BELOW. CONTACT BALLAST MANUFACTURER FOR SPECIFICATIONS.

CDM7-120/277 - ADVANCE MARK 7 0-10v ELECTRICAL BALLST – 120/277 VOLT

CDM10-120 - ADVANCE MARK 10 ELECTRICAL BALLST – 120 VOLT

CDM10-277 - ADVANCE MARK 10 ELECTRICAL BALLST – 277 VOLT



I – GLASS OPTIONS

*NOTE: MUST USE TEMPERED GLASS FOR LIGHT FIXTURES USING HIGH INTENSITY DISCHARGE (HID) LIGHT SOURCE OPTION.



CL3 3" CLEAR GLASS
CLT3 3" CLEAR TEMPERED



PR3 3" PRISMATIC GLASS



RE3 3" RED GLASS



BL3 3" BLUE GLASS



FR3 3" FROSTED GLASS
FRT3 3" FROSTED TEMPERED



AH3 3" AMBER HYDE GLASS



GR3 3" GREEN GLASS

GLASS – DIMENSIONS 3" GLASS	
Diameter	3.34"
Height	6.93"
Fitter	3.29"

GLASS – MAX WATTAGE 3" GLASS – 100W INC / LED12W	
---	--

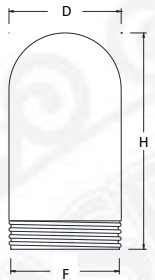

J – ACCESSORIES

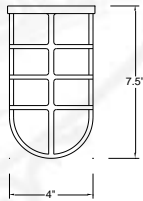

GU-1 CAST ALUMINUM GUARD

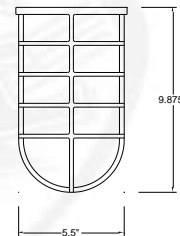

GU-2 CAST ALUMINUM GUARD