



BASELITE – VENTED SHADE – CF – SPEC SHEET



PROJECT NAME: _____ PROJECT TYPE: _____

MODEL #	/	/	/	/	/	/	/	/	/	/	/
EXAMPLE:	V212	41	E16	SQ ½"	43	12W	3K	LDM120	PR3	GR12	44

*SKIP SECTION IF OPTION DOES NOT APPLY

NOTES:



A - SHADES

VENTED SHADES

- V212- 32WCF (MAX)
- V214- 42WCF (MAX)
- V216- 42WCF (MAX)
- V218- 42WCF (MAX)
- V220- 42WCF (MAX)

B - FINISH OPTIONS

(SEE WEBSITE FOR SWATCH COLORS)
(*SEE NOTES FOR LIMITATIONS*)

- 14, 15, 16, 17, 18, 19, 19P, 20, 20P, 20PB, 20SB, 21, 21P, 22, 22P, 23, 23P, 38, 39, 40, 41, 41.5, 42, 43, 44, 45, 46, 48, 49, 50, 51, 52, 53, 54, 55, 57, 58, 59, 60, 61, 62, 63, 64, 65, 66, 70, 71, 72, 73, 74, 75, 76, 77, 78, 79, 80, 81, 82, 83, 84, 85, 86, 87, 88, 89, 90, 91, 92, 93, 94, 95, 96, 97, 98, 99, 100, MG.

C – MOUNTING OPTIONS

½" ARM EXTENSIONS

- E1, E2, E3, E4, B1, E16, E17, E18

¾" ARM EXTENSIONS

- E3A, E4A, E5, E6, E7, E8, E9, E10, E11, E12, E13, B15, B15S, E19, E20, E21, E25

E14 - CREATE YOUR OWN

(BASELITE WILL TAKE YOUR SKETCH AND FABRICATE A CUSTOM ARM EXTENSION TO MEET YOUR NEEDS).

½" WALL MOUNT

- B13, WM13R, WM13X, B10, B11, B101

¾" WALL MOUNT

- B9, B9C, B12, WM10, WM11, WM14X, WM15, WM35X, WM55X, WM60X, WM61X WM70X, WM71X

COMPACT FLUORESCENT CORD MOUNT

- CFBLC, CFWHC, CFTCB, CFTCW, CFTCHB, CFTCHW, CFTLB, CFTLW, CFRCB, CFRCW, CFRCHB, CFRCHW, CFFHB, CFFHW, CFHBLC, CFHWHC, CFCBLC, CFCWHC

STEM MOUNT

- ST6, ST12, ST18, ST24, ST36, ST48, STXX

D – MOUNTING ADD-ONS

CF ADD-ONS

- CFWTM, CFSLC, CFSTC

UNIVERSAL ADD-ONS

- SQ ½", SQ ¾", FH ½", FH ¾", TRB ½", TRB ¾", SWL, LGSWL, CNK, INB, RINB

E – MOUNTING COLOR

SEE SECTION "B" FOR COLOR OPTIONS.

F – LIGHT SOURCE

(SEE PAGE 4 FOR WATTAGE LIMITATIONS)

COMPACT FLUORESCENT (CF)

- 26W, 32W, 42W

G – LED COLOR TEMP

NOT AVAILABLE

H – ELECTRICAL OPTION

(SEE PAGE 4 FOR DIMMING OPTION SPECIFICATIONS)

CDM120

CDM277

CDM120/277

I – GLASS OPTIONS

- CL3, CL4, CLT3, CLT4, BL3, BL4, RE3, RE4, GR3, GR4, AH3, AH4, FR3, FR4, FRT3, FRT4, PR3, PR4, BA, BAX, BAF, PR8, PR8F, FN, OC

J – ACCESSORIES

- GR12, GR14, GR16, GR18, GR20, REF, UGR, LGR12, LGR14, LGR16, LGR18, LGR20, CRL12, CRL14, CRL16, CRL18, CRL20, FLE12, FLE14, FLE16, FLE18, FLE20, FGR12, FGR14, FGR16, FGR18, FGR20, GU-1, GU-2, WG-1, WG-2

K – ACCESSORY COLOR

SEE SECTION "B" FOR COLOR OPTIONS.

NOTES

- (1). FINISH OPTIONS 75,76, 77, 83, 84, 88, 93 AND 98 ARE APPLIED BY HAND. THESE FINISHES WILL VARY IN CONSISTENCY.
- (2). FINISH OPTIONS 38, 39, 40, 49, 54, 57, 58, 61, 62, 63, 70, 71, 72, 73, 78, 83, 84, 88, 92, 93, 98 ONLY AVAILABLE INSIDE AND OUT OF FIXTURE. OTHER FINISHES ARE WHITE INSIDE.
- (3). FINISH OPTIONS FOR SHADES ≤ 10" IN DIAMETER ARE THE SAME INSIDE AND OUT OF FIXTURE. SHADES > 10" IN DIAMETER ARE WHITE ON THE INSIDE.
- (4). FINISH OPTIONS 61, 62, 70, 71, 72, 73 ARE FINISHED WITH A SUPERCHROME ON THE INSIDE FOR ALL LED LIGHT SOURCE OPTIONS.
- (5). COLOR CORDS ARE NOT APPLICABLE FOR LED OPTIONS.
*ALL ARMS COME WITH A CAST BACKPLATE (CB1/2", CB3/4", LWTM, CFWTM, ECT.).
*ACCORDING TO THE LIGHT SOURCE THE BACKPLATE MAY VARY IN SIZE. (EXAMPLE: LED LIGHT SOURCE WILL HAVE A DEEPER BACKPLATE TO HOUSE THE DRIVER.).
*ALL FIXTURES MOUNT TO A 4-0 JUNCTION BOX.
*FIXTURE DIMENSIONS MAY VARY ± 0.25.
*SHADES RATED FOR DRY LOCATION ONLY.
*CORD AND CANOPY COME IN THE SAME COLOR.

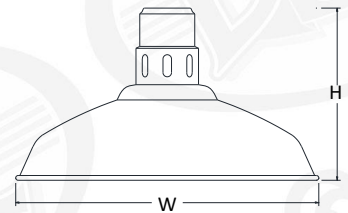

V212	H-8"	W-12"
V214	H-9"	W-14"
V216	H-9"	W-16"
V218	H-10"	W-18"
V220	H-10"	W-20"



C - MOUNTING OPTIONS

1/2" ARM EXTENSIONS

*ARMS RATED FOR WET LOCATION * MAXIMUM SECTIONS OF ARMS ARE DIMENSIONED

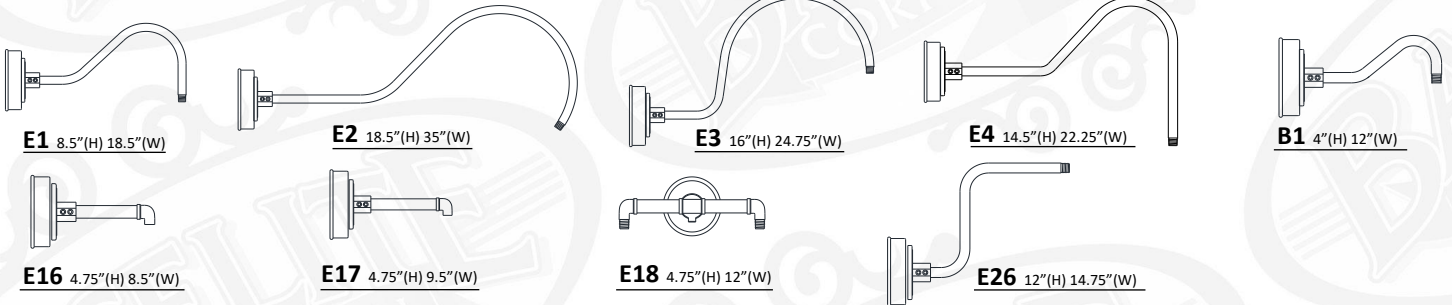

3/4" ARM EXTENSIONS

*ARMS RATED FOR WET LOCATION * MAXIMUM SECTIONS OF ARMS ARE DIMENSIONED

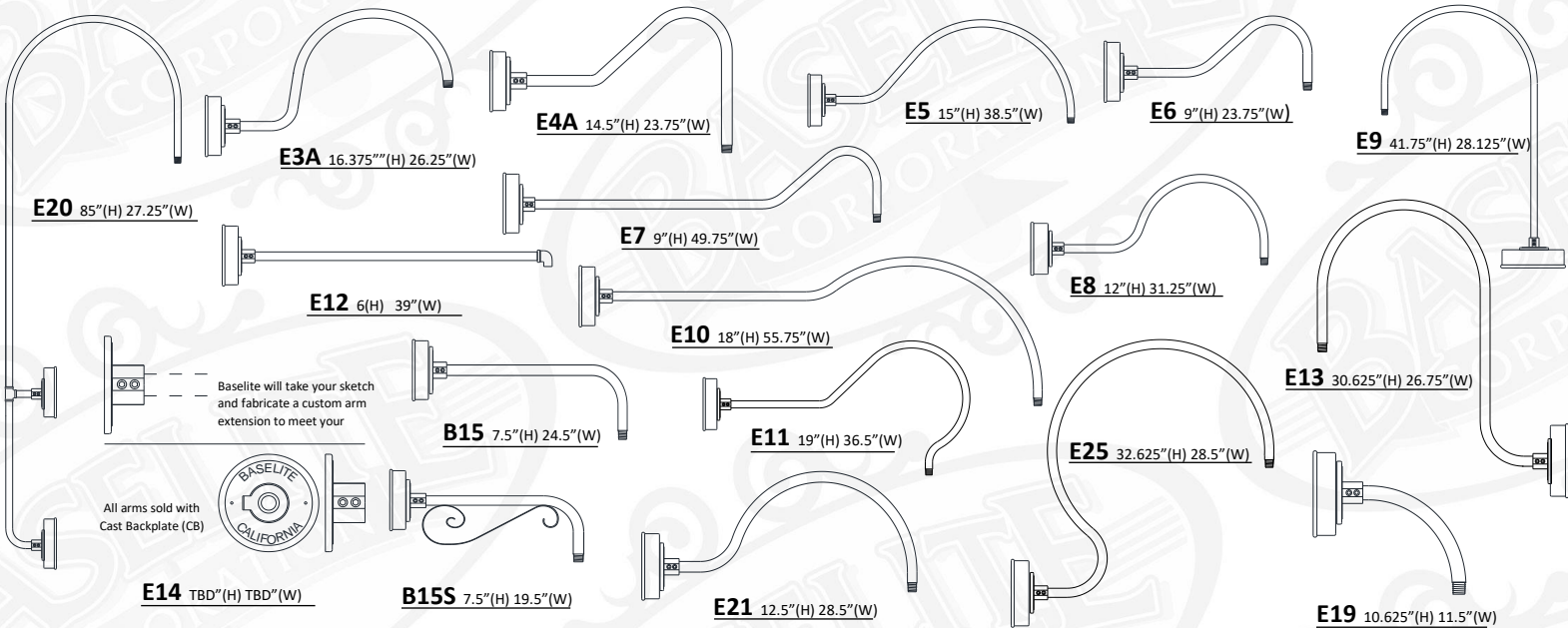

1/2" WALL MOUNTS

*MOUNTS RATED FOR WET LOCATION * MAXIMUM SECTIONS OF MOUNTS ARE DIMENSIONED

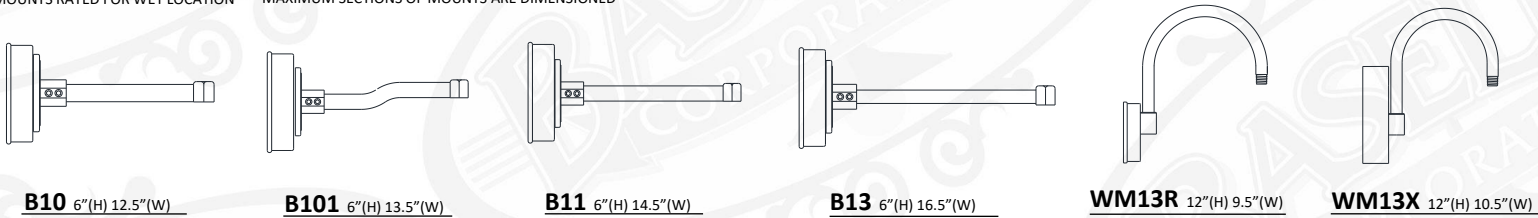

3/4" WALL MOUNTS

*MOUNTS RATED FOR WET LOCATION * MAXIMUM SECTIONS OF MOUNTS ARE DIMENSIONED

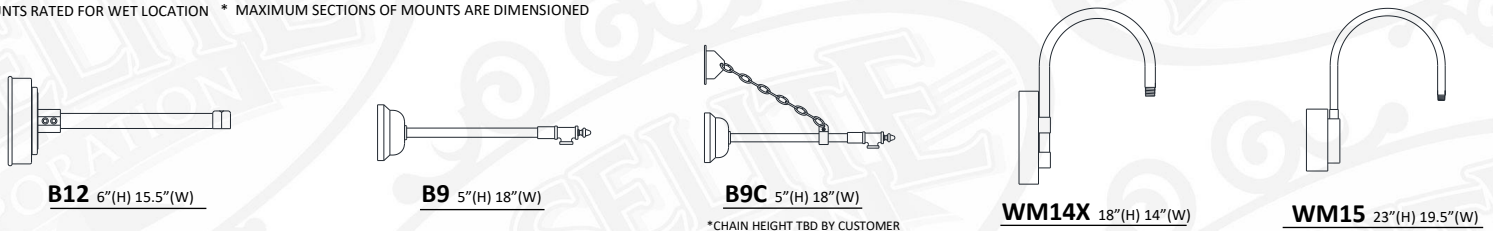



C - MOUNTING OPTIONS (CONTINUED)

3/4" WALL MOUNTS

*MOUNTS RATED FOR WET LOCATION * MAXIMUM SECTIONS OF MOUNTS ARE DIMENSIONED



WM35X 26"(H) 22"(W)



WM55X 19"(H) 27"(W)

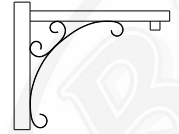

WM60X 18"(H) 22"(W)

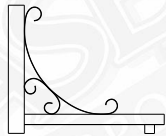

WM61X 18"(H) 22"(W)

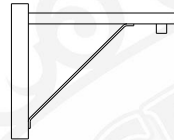

WM70X 18"(H) 22"(W)

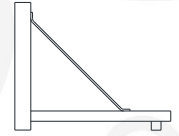

WM71X 18"(H) 22"(W)

STEM MOUNTS

*STEMS RATED FOR DAMP LOCATION

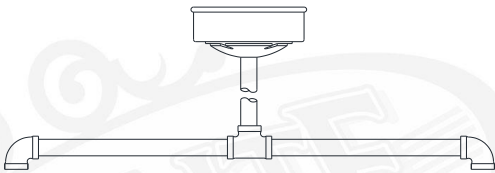

DP24 DOUBLE PENDANT 20"(H) 24"(W)

*DP24 COMES STANDARD WITH CFSTC AND ST18



ST(XX) STEM- 1/2" NPT

XX = LENGTH OF STEM
(EXAMPLE - "ST18" = STEM MOUNT 18" LENGTH)
*CANOPY NOT INCLUDED, ADD IN SECTION D
* 1/4" NPT AND 3/4" NPT AVAILABLE UPON REQUEST



SC24 SCROLL STEM 33"(H) 26"(W)

*SC24 COMES STANDARD WITH CFSTC

COMPACT FLUORESCENT CORD MOUNTS

*FOR LED & COMPACT FLUORESCENT OPTIONS, CANOPIES WILL VARY IN SIZE DUE TO SIZE OF THE DRIVER/BALLAST THAT WILL BE LOCATED INSIDE OF THE CANOPY.
*CORDS RATED FOR DRY LOCATION *CANOPY DIMENSIONS: 3" (H) 6" (W) *CORD AND CANOPY COME IN THE SAME COLOR.



CFBLC 8' BLACK CORD

CFWHC 8' WHITE CORD

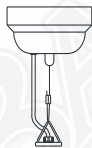

CFTCB 8' BLACK CORD, CABLE, and LOOP

CFTCW 8' WHITE CORD, CABLE, and LOOP



CFTCHB 8' BLACK CORD, 3" CHAIN, and LOOP

CFTCHW 8' WHITE CORD, 3" CHAIN, and LOOP



CFRCB 8' BLACK CORD, CABLE, and LOOP

CFRCW 8' WHITE CORD, CABLE, and LOOP



CFRCHB 8' BLACK CORD, 3" CHAIN, and LOOP

CFRCHW 8' WHITE CORD, 3" CHAIN, and LOOP



CFFHB 8' BLACK CORD WITH FLAT HUB

CFFHW 8' WHITE CORD WITH FLAT HUB



CFCBLC 8' BLACK CORD and CABLE

CFCWHC 8' WHITE CORD and CABLE

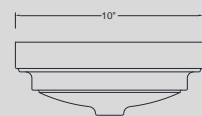

NOTES:

*DISTANCE TO LAMP (CF) 10"
*All compact fluorescent and LED housings may vary in size according to light source chosen.



I – GLASS OPTIONS

*NOTE: MUST USE TEMPERED GLASS FOR LIGHT FIXTURES USING HIGH INTENSITY DISCHARGE (HID) LIGHT SOURCE OPTION.



CL3 3" CLEAR GLASS



PR3 3" PRISMATIC GLASS



RE3 3" RED GLASS



BL3 3" BLUE GLASS

CL4 4" CLEAR GLASS

PR4 4" PRISMATIC GLASS

RE4 4" RED GLASS

BL4 4" BLUE GLASS

CLT3 3" CLEAR TEMPERED

CLT4 4" CLEAR TEMPERED



FR3 3" FROSTED GLASS



AH3 3" AMBER HYDE GLASS



GR3 3" GREEN GLASS

FR4 4" FROSTED GLASS

AH4 4" AMBER HYDE GLASS

GR4 4" GREEN GLASS

FRT3 3" FROSTED TEMPERED

FRT4 4" FROSTED TEMPERED

GLASS – DIMENSIONS	
3" GLASS	
Diameter	3.34"
Height	6.93"
Fitter	3.29"
4" GLASS	
Diameter	4.34"
Height	8.37"
Fitter	4.29"

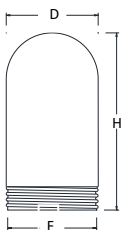

GLASS – MAX WATTAGE	
3" GLASS	100W INC / LED12W
4" GLASS	200W INC / LED25W



BA 6" OPAL BALL
(100W INC MAX/LED12W)



BAX 9" CLEAR GLOBE
BAF 9" FROSTED GLOBE
(200W INC MAX/LED25W)



FN 8" CLEAR TEXTURED GLOBE
(150W INC MAX/LED25W)



BA7 7" CLEAR GLOBE



PR8 8" PRISMATIC



OC 8" OPAL TAPERED GLOBE
(60W INC MAX/LED25W)

BA7F 7" FROSTED GLOBE
(100W INC MAX/LED25W)

PR8F 8" PRISMATIC FROSTED
(200W INC MAX/LED45W)

J – ACCESSORIES

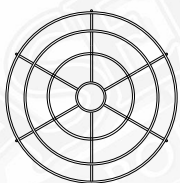

GR12 12" WIRE GRILL



LGR12 12" LOUVERED GRILL

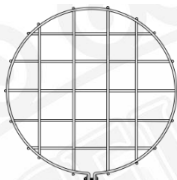

FGR12 12" FLAT GRILL

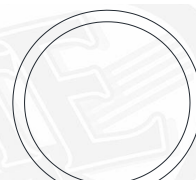

CRL12 12" CURVED POLYCARB LENSE

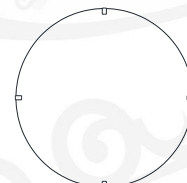

FLE12 12" FLAT CLEAR LENSE



GR14 14" WIRE GRILL



LGR14 14" LOUVERED GRILL



FGR14 14" FLAT GRILL



CRL14 14" CURVED POLYCARB LENSE



FLE14 14" FLAT CLEAR LENSE

GR16 16" WIRE GRILL

LGR16 16" LOUVERED GRILL

FGR16 16" FLAT GRILL

CRL16 16" CURVED POLYCARB LENSE

FLE16 16" FLAT CLEAR LENSE

GR18 18" WIRE GRILL

LGR18 18" LOUVERED GRILL

FGR18 18" FLAT GRILL

CRL18 18" CURVED POLYCARB LENSE

FLE18 18" FLAT CLEAR LENSE

GR20 20" WIRE GRILL

LGR20 20" LOUVERED GRILL

FGR20 20" FLAT GRILL

CRL20 20" CURVED POLYCARB LENSE

FLE20 20" FLAT CLEAR LENSE

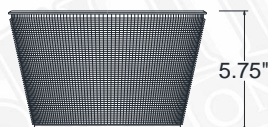

REF 9.5" DIAMETER REFRACTOR



UGR U- WIRE GUARD

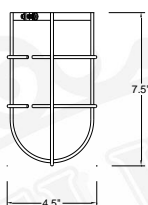

WG-1 WIRE GUARD

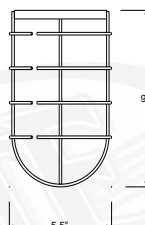

WG-2 WIRE GUARD

Available for shades
12" or higher

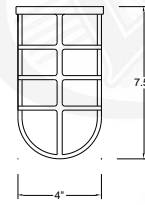

GU-1 CAST ALUMINUM GUARD

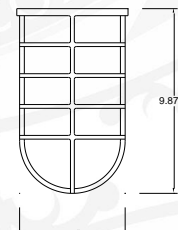

GU-2 CAST GUARD

Available for shades
12" or higher