

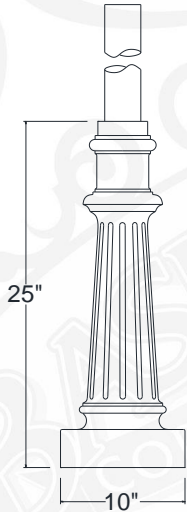

C - MOUNTING OPTIONS

CAST ALUMINUM POLE BASES



TYPE A	HEIGHT	SHAFT SIZE
3AAP8	8'0"	3" ROUND
3AAP10	10'0"	3" ROUND
3AAP12	12'0"	3" ROUND
4AAP8	8'0"	4" ROUND
4AAP10	10'0"	4" ROUND
4AAP12	12'0"	4" ROUND
3FAP8	8'0"	3" FLUTED
3FAP10	10'0"	3" FLUTED
3FAP12	12'0"	3" FLUTED
4FAP8	8'0"	4" FLUTED
4FAP10	10'0"	4" FLUTED
4FAP12	12'0"	4" FLUTED

*BOLT SIZE 1/2" X 15"

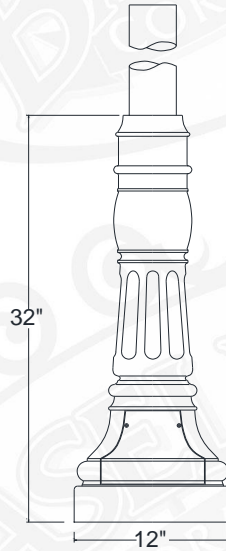
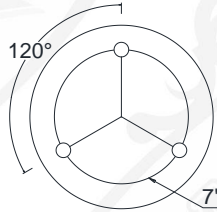
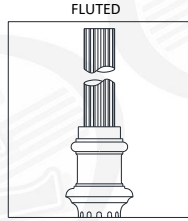

TYPE B	HEIGHT	SHAFT SIZE
3ABP8	8'0"	3" ROUND
3ABP10	10'0"	3" ROUND
3ABP12	12'0"	3" ROUND
4ABP8	8'0"	4" ROUND
4ABP10	10'0"	4" ROUND
4ABP12	12'0"	4" ROUND
3FBP8	8'0"	3" FLUTED
3FBP10	10'0"	3" FLUTED
3FBP12	12'0"	3" FLUTED
4FBP8	8'0"	4" FLUTED
4FBP10	10'0"	4" FLUTED
4FBP12	12'0"	4" FLUTED

*BOLT SIZE 1/2" X 15"

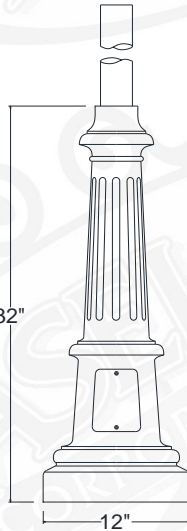
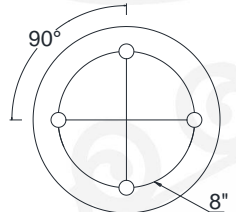
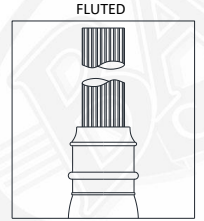

TYPE C	HEIGHT	SHAFT SIZE
3ACP8	8'0"	3" ROUND
3ACP10	10'0"	3" ROUND
3ACP12	12'0"	3" ROUND
4ACP8	8'0"	4" ROUND
4ACP10	10'0"	4" ROUND
4ACP12	12'0"	4" ROUND
3FCP8	8'0"	3" FLUTED
3FCP10	10'0"	3" FLUTED
3FCP12	12'0"	3" FLUTED
4FCP8	8'0"	4" FLUTED
4FCP10	10'0"	4" FLUTED
4FCP12	12'0"	4" FLUTED

*BOLT SIZE 1/2" X 15"

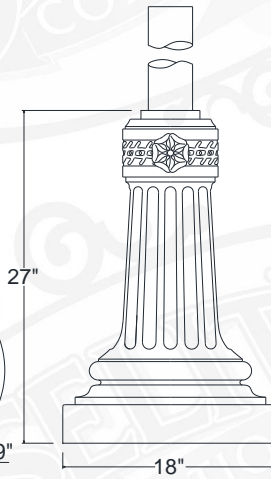
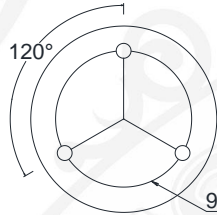
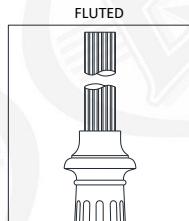

TYPE D	HEIGHT	SHAFT SIZE
3ADP8	8'0"	3" ROUND
3ADP10	10'0"	3" ROUND
3ADP12	12'0"	3" ROUND
4ADP8	8'0"	4" ROUND
4ADP10	10'0"	4" ROUND
4ADP12	12'0"	4" ROUND
3FDP8	8'0"	3" FLUTED
3FDP10	10'0"	3" FLUTED
3FDP12	12'0"	3" FLUTED
4FDP8	8'0"	4" FLUTED
4FDP10	10'0"	4" FLUTED
4FDP12	12'0"	4" FLUTED

*BOLT SIZE 1/2" X 15"

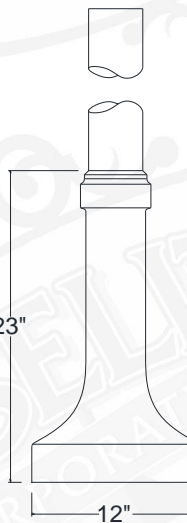
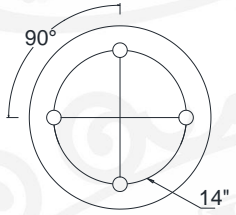
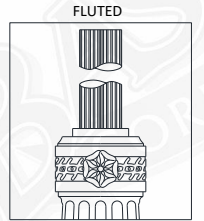

TYPE E	HEIGHT	SHAFT SIZE
3AEP8	8'0"	3" ROUND
3AEP10	10'0"	3" ROUND
3AEP12	12'0"	3" ROUND
4AEP8	8'0"	4" ROUND
4AEP10	10'0"	4" ROUND
4AEP12	12'0"	4" ROUND
3FEP8	8'0"	3" FLUTED
3FEP10	10'0"	3" FLUTED
3FEP12	12'0"	3" FLUTED
4FEP8	8'0"	4" FLUTED
4FEP10	10'0"	4" FLUTED
4FEP12	12'0"	4" FLUTED

*BOLT SIZE 1/2" X 15"

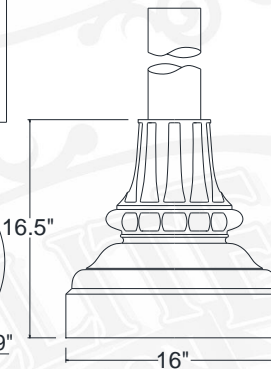
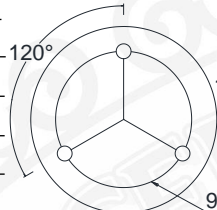
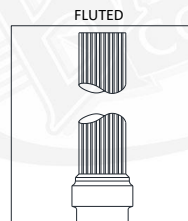

TYPE G	HEIGHT	SHAFT SIZE
3AGP8	8'0"	3" ROUND
3AGP10	10'0"	3" ROUND
3AGP12	12'0"	3" ROUND
4AGP8	8'0"	4" ROUND
4AGP10	10'0"	4" ROUND
4AGP12	12'0"	4" ROUND
3FGP8	8'0"	3" FLUTED
3FGP10	10'0"	3" FLUTED
3FGP12	12'0"	3" FLUTED
4FGP8	8'0"	4" FLUTED
4FGP10	10'0"	4" FLUTED
4FGP12	12'0"	4" FLUTED

*BOLT SIZE 1/2" X 15"

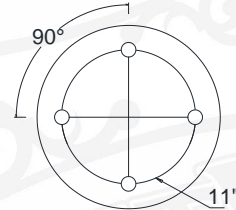
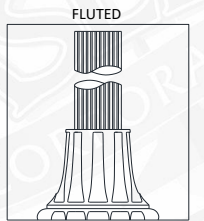



C - MOUNTING OPTIONS

POLE MOUNTS

ALUMINUM FLUTED

3FFP8	8'0"	3" FLUTED
3FFP10	10'0"	3" FLUTED
3FFP12	12'0"	3" FLUTED
4FFP8	8'0"	4" FLUTED
4FFP10	10'0"	4" FLUTED
4FFP12	12'0"	4" FLUTED

*BOLT SIZE 1/2" X 15"

DIRECT BURIAL

3DBP8	8'0" (9'6")	3" ROUND
3DBP10	10'0" (11'6")	3" ROUND
3DBP12	12'0" (13'6")	3" ROUND
4DBP8	8'0" (9'6")	4" ROUND
4DBP10	10'0" (11'6")	4" ROUND
4DBP12	12'0" (13'6")	4" ROUND

*Hand hole provide. 125" Aluminum Pole

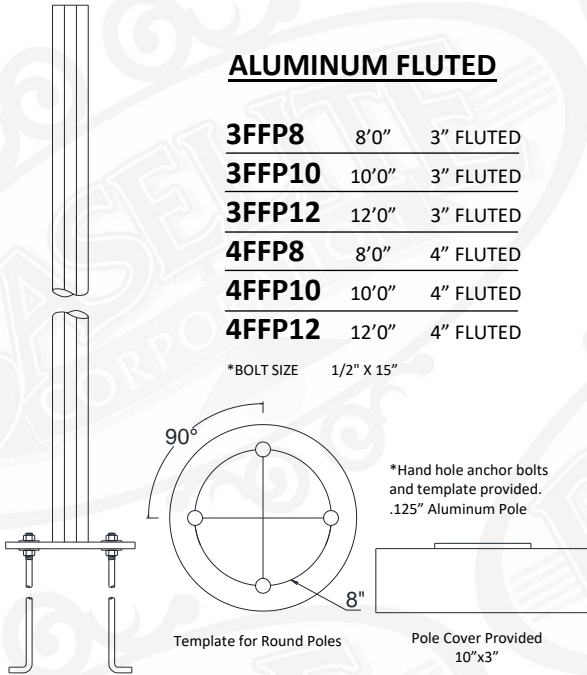

STEEL POLES (ROUND)

3STP8	8'0"	3" ROUND
3STP10	10'0"	3" ROUND
3STP12	12'0"	3" ROUND
4STP8	8'0"	4" ROUND
4STP10	10'0"	4" ROUND
4STP12	12'0"	4" ROUND

*BOLT SIZE 1/2" X 15"

STEEL POLES (SQUARE)

3SQP10	10'0"	3" SQUARE
3SQP12	12'0"	3" SQUARE
4SQP8	8'0"	4" SQUARE
4SQP10	10'0"	4" SQUARE
4SQP12	12'0"	4" SQUARE

*BOLT SIZE 1/2" X 15"

