



BASELITE – MODERN PENDANTS – LED – SPEC SHEET



PROJECT NAME: _____ PROJECT TYPE: _____

MODEL #	/	/	/	/	/	/	X	/	X	/	X	/	X	/	X
EXAMPLE:	3TD	80-59-81	BLC	CNK	41	150INC									

*SKIP SECTION IF OPTION DOES NOT APPLY

NOTES:



A - SHADES

MODERN PENDANTS

- 3TD – 25WLED (MAX)
- 3PEH – 25WLED (MAX)
- 3PE – 25WLED (MAX)
- PEA – 25WLED (MAX)
- PEB – 25WLED (MAX)
- PEC – 25WLED (MAX)
- PED – 25WLED (MAX)
- PEF – 25WLED (MAX)
- PEG – 25WLED (MAX)
- PEH – 25WLED (MAX)
- PEI – 25WLED (MAX)
- PEJ – 25WLED (MAX)
- PEK – 25WLED (MAX)
- PEL – 25WLED (MAX)
- PELB – 25WLED (MAX)
- PEM – 25WLED (MAX)
- PEMB – 25WLED (MAX)
- PEN – 25WLED (MAX)
- PENB – 25WLED (MAX)
- PEO – 25WLED (MAX)
- PEOB – 25WLED (MAX)
- PEP – 25WLED (MAX)
- PEQ – 25WLED (MAX)
- PER – 25WLED (MAX)
- PES – 25WLED (MAX)
- PET – 25WLED (MAX)
- PEU – 25WLED (MAX)
- PEV – 25WLED (MAX)
- PEX – 25WLED (MAX)
- DMD10 – 25WLED (MAX)
- SQB618 – 25WLED (MAX)
- S1 – N/A (LED LAMP ONLY)
- TD8 – 25WLED (MAX)
- TD10 – 25WLED (MAX)
- TD12 – 25WLED (MAX)
- PEHD615 – 25WLED (MAX)

B - FINISH OPTIONS

(SEE WEBSITE FOR SWATCH COLORS)
 (*SEE NOTES FOR LIMITATIONS*)
 14, 15, 16, 17, 18, 19, 19P, 20, 20P, 20PB,
 20SB, 21, 21P, 22, 22P, 23, 23P, 38, 39, 40,
 41, 41.5, 42, 43, 44, 45, 46, 48, 49, 50, 51,
 52, 53, 54, 55, 57, 58, 59, 60, 61, 62, 63, 64,
 65, 66, 70, 71, 72, 73, 74, 75, 76, 77, 78, 79,
 80, 81, 82, 83, 84, 85, 86, 87, 88, 89, 90, 91,
 92, 93, 94, 95, 96, 97, 98, 99, 100, MG.

C – MOUNTING OPTIONS

LED CORD MOUNT
 LBLC, LWHC, LTCB, LTCW, LTCHB, LTCHW,
 LTLB, LTLW, LTLB, LTLW, LRCB, LRCW,
 LRCHB, LRCHW, LFHB, LFHW, LHBL, C,
 LHWHC, LCBL, LCWHC

STEM MOUNT (INC)
 ST6, ST12, ST18, ST24, ST36, ST48, STXX

D – MOUNTING ADD-ONS

INC ADD-ONS
 CNK – MULTIPLE FIXTURE CANOPY
 STC – STEM MOUNT CANOPY
 SLC1/2" – SLOPE CEILING CANOPY 1/2"

E – MOUNTING COLOR

SEE SECTION "B" FOR COLOR OPTIONS.

F – LIGHT SOURCE

(SEE PAGE 3 FOR WATTAGE LIMITATIONS)
LIGHT EMITTED DIODE (LED)
 12W, 25W

G – LED COLOR TEMP

- 27K – 2700 K
- 3K – 3000 K
- 35K – 3500 K
- 4K – 4000 K
- 5K – 5000 K

H – ELECTRICAL OPTION

(SEE PAGE 3 FOR DIMMING OPTION SPECIFICATIONS)
LDM120
LDM277
LDM0-10

I – GLASS OPTIONS

CALL FACTORY FOR REQUEST.

J – ACCESSORIES

CALL FACTORY FOR REQUEST.

K – ACCESSORY COLOR

SEE SECTION "B" FOR COLOR OPTIONS.

NOTES

- (1). FINISH OPTIONS 20, 21, 22, 23 ARE FOR SOLID BRASS FIXTURES ONLY.
- (2). FINISH OPTIONS 19, 21, 22, 23, 75,76, 77, 83, 84, 88, 93 AND 98 ARE APPLIED BY HAND. THESE FINISHES WILL VARY IN CONSISTENCY.
- (3). FINISH OPTIONS FOR SHADES ≤ 10" IN DIAMETER ARE THE SAME INSIDE AND OUT OF FIXTURE. SHADES > 10" IN DIAMETER ARE WHITE ON THE INSIDE.
- (4). FINISH OPTIONS 19, 38, 39, 40, 49, 54, 57, 58, 61, 62, 63, 70, 71, 72, 73, 78, 83, 84, 88, 92, 93, 98 ONLY AVAILABLE INSIDE AND OUT OF FIXTURE. OTHER FINISHES ARE WHITE INSIDE.
- (5). FINISH OPTIONS 61, 62, 70, 71, 72, 73 ARE FINISHED WITH A SUPERCHROME ON THE INSIDE FOR ALL LED LIGHT SOURCE OPTIONS.
- (6). COLOR CORDS ARE NOT APPLICABLE FOR LED OPTIONS.
 *ALL FIXTURES MOUNT TO A 4-O JUNCTION BOX.
 *FIXTURE DIMENSIONS MAY VARY ± 0.25.

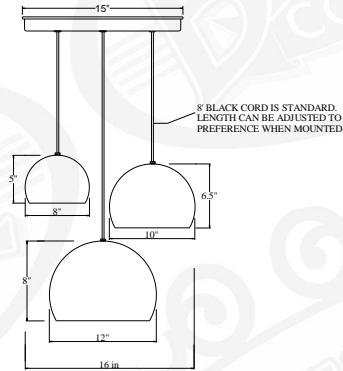

3TD H-TBD W-16"

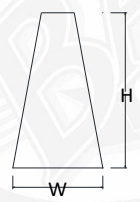

PEA H-15" W-8.75"

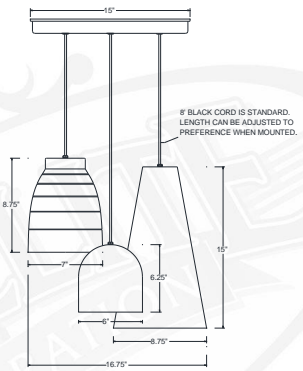

3PE H-TBD W-16.75"

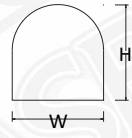

PEB H-6.25" W-6"

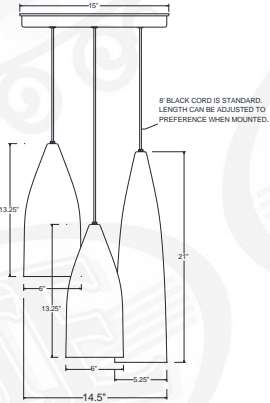

3PEH H-TBD W-14.5"

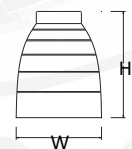

PEC H-8.75" W-7"



A - SHADES

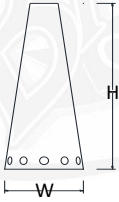

PED H-11" W-4.5"

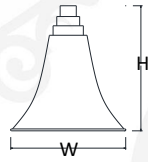

PEF H-13" W-12"

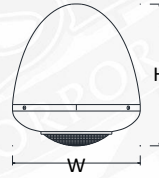

PEG H-11" W-10"

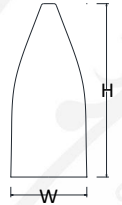

PEH H-13.25" W-6"

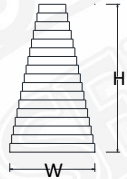

PEJ H-10" W-5.75"

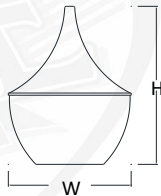

PEL H-18" W-14"

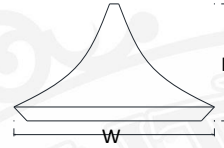

PEM H-12" W-22"



PEN H-24" W-10"

PEK H-7.5" W-5"

PELB H-11" W-9.5"

PEMB H-9" W-14"

PENB H-15.75" W-7.5"

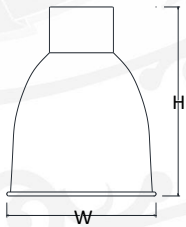

PEO H-16.5" W-14"



PEOB H-12" W-7"

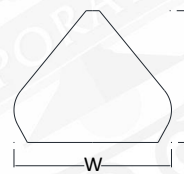

PEP H-15" W-18"

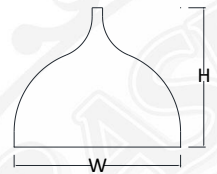

PEQ H-13.5" W-16"

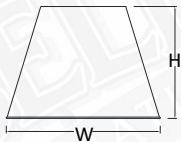

PER H-10.5" W-14.5"

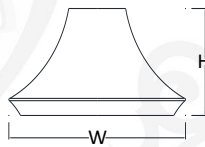

PES H-11.75" W-22.5"

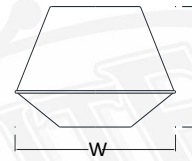

PET H-12" W-18"

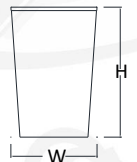

PEU H-9.5" W-14.25"

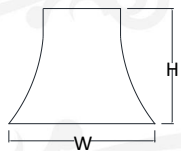

PEV H-16.5" W-13"



PEX H-11" W-12"

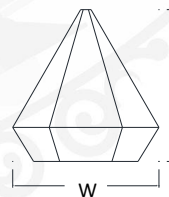

DMD10 H-14.5" W-14"



SQB618 H-18" W-6"

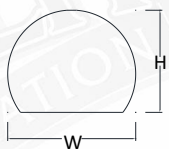

TD8 H-6.625" W-8"

TD10 H-8" W-10"

TD12 H-9.375" W-12"



S1 H-2.625" W-2"



C - MOUNTING OPTIONS

D - MOUNTING ADD-ONS

STEM MOUNT

*STEMS RATED FOR DAMP LOCATION * 1/4" NPT AND 3/4" NPT AVAILABLE UPON REQUEST



ST(XX) STEM- 1/2"

XX = LENGTH OF STEM
(EXAMPLE - "ST18" = STEM MOUNT 18" LENGTH)
*CANOPY NOT INCLUDED, ADD IN SECTION D

MOUNTING ADD-ON



CNK CANOPY For MULTIPLE FIXTURES

*CNK dimensions vary on number of fixtures applied

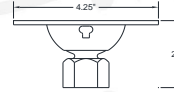

SLC 1/2" SLOPE CEILING CANOPY 1/2"

*(Slopes To 20 Degrees)

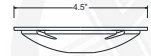

STC 1/2" 1/2" STEM MOUNT CANOPY

LED CORD MOUNTS

FOR LED & COMPACT FLUORESCENT OPTIONS, CANOPIES WILL VARY IN SIZE DUE TO SIZE OF THE DRIVER/BALLAST THAT WILL BE LOCATED INSIDE OF THE CANOPY. *CORDS RATED FOR DRY LOCATION *CANOPY DIMENSIONS: 3" (H) 6" (W)



LBLC 8' BLACK CORD

LWHC 8' WHITE CORD

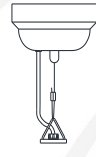

LTCB 8' BLACK CORD, CABLE, and LOOP

LTCW 8' WHITE CORD, CABLE, and LOOP



LTCHB 8' BLACK CORD, 3" CHAIN, and LOOP

LTCHW 8' WHITE CORD, 3" CHAIN, and LOOP

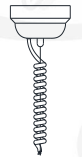

LTLB 8' BLACK TELEPHONE CORD AND CABLE

LTLW 8' WHITE TELEPHONE CORD AND CABLE

* Not available with compact fluorescent

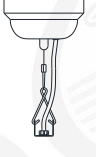

LRCB 8' BLACK CORD, CABLE, and LOOP

LRCW 8' WHITE CORD, CABLE, and LOOP



LRCHB 8' BLACK CORD, 3" CHAIN, and LOOP

LRCHW 8' WHITE CORD, 3" CHAIN, and LOOP



LFHB 8' BLACK CORD WITH FLAT HUB

LFHW 8' WHITE CORD WITH FLAT HUB



LCBLC 8' BLACK CORD and CABLE

LCWHC 8' WHITE CORD and CABLE

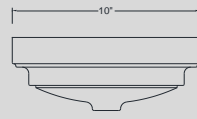

NOTES:
*DISTANCE TO LAMP (CF) 10"
*All compact fluorescent and LED housings may vary in size according to light source chosen.

F – LIGHT SOURCE

BASELITE'S PUBLISHED LUMINAIRE PHOTOMETRIC TESTING WAS PERFORMED IN A 3-METER INTEGRATING SPHERE USING THE 4TT GEOMETRY METHOD. DATA IS CONSIDERED TO BE REPRESENTATIVE OF THE CONFIGURATIONS SHOWN, WITHIN THE TOLERANCES ALLOWED BY LIGHTING FACTS. TO OBTAIN AN IES FILE SPECIFIC TO YOUR PROJECT, PLEASE CONTACT THE FACTORY.

LIGHT EMITTING DIODE (LED)

LED 25W (MAX) - 3TD, 3PEH, 3PE, PELB, PEMB, PENB, S1, TD8, TD10, TD12, PEA, PEB, PEC, PED, PEF, PEG, PEH, PEI, PEJ, PEK, PEL, PEM, PEN, PEO, PEP, PEQ, PER, PES, PET, PEU, PEV, PEX, DMD10, SQB618, WRO, WRO1, WRO2, PEHD615

*IMPORTANT – FOR LIGHT EMITTED DIODE (LED) LIGHT SOURCE OPTION FIXTURES ARE LIMITED DUE TO SIZE OF THE FIXTURE AND THE CORD WATTAGE RESTRICTIONS. PLEASE SEE AVAILABILITY CHART TO THE LEFT.

EXAMPLE: / LED25W /

OPTION	WATTAGE	LUMENS	CRI	VOLTAGE	DIMMING
LED12W	12W	1000 1200	>90	120-277 VAC	See section "H"
LED25W	25W	1900 2000	>90	120-277 VAC	See section "H"
		@3000K @5000K			

H – ELECTRICAL OPTION

MOST BASELITE'S ELECTRICAL OPTIONS ARE ONLY COMPATIBLE FOR CERTAIN FIXTURES. PLEASE SEE NOTES BELOW AND FOR FURTHER DEATIALS CONTACT THE FACTORY. FOR DIMMING BALLAST OPTION PLEASE CHOOSE MARK X OR MARK VII, SO RESTRICTIONS APPLY DUE TO THE SIZE OF THE BALLAST AND FIXTURE.

LED DIMMING OPTIONS

FOR TRIAC OR 0-10V OPTOIN CHOOSE FROM THE FOLLOWING. CONTACT DRIVER MANUFACTURER FOR SPECIFICATIONS.

LDM120 - TRIAC DIMMING AT 120 VOLT

LDM277 - TRIAC DIMMING AT 277 VOLT

LDM0-10V - 0 – 10v