

BASELITE

FOOD WARMER CATALOG





Baselite foodwarmers are designed to compliment and enhance the aesthetic appeal, design and decor of any eatery, while serving the purpose of maintaining food serving temperatures. Not only do they compliment the restaurants decor they are built to the highest commercial standards. Shades are constructed from a high grade aluminum, brass or copper and hand spun at our own facility. Offering thirty five different powder coat and metal finishes, along with a wide range of shade styles, mounting options and accessories to meet your lighting needs. All Baselite products are handmade in the U.S.A. guaranteeing a premium quality product.

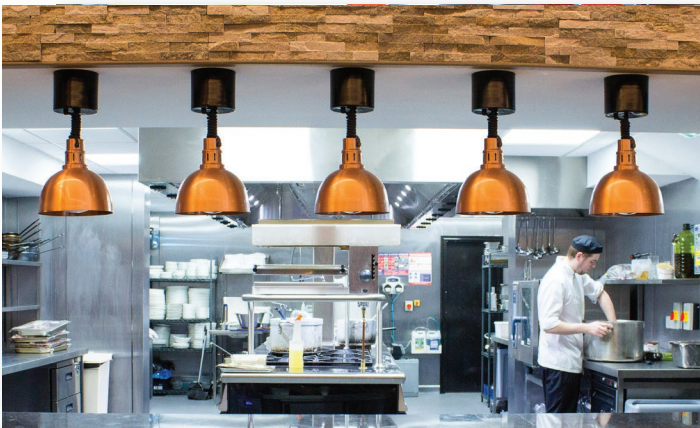

ORDERING GUIDE

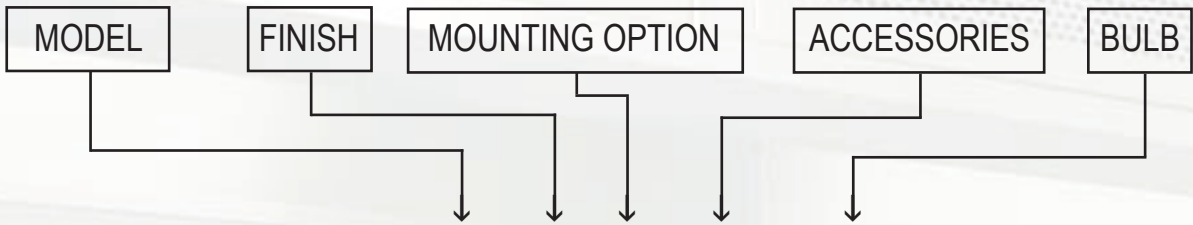

EXAMPLE : FW17/74/TLB/TSF/250WCC

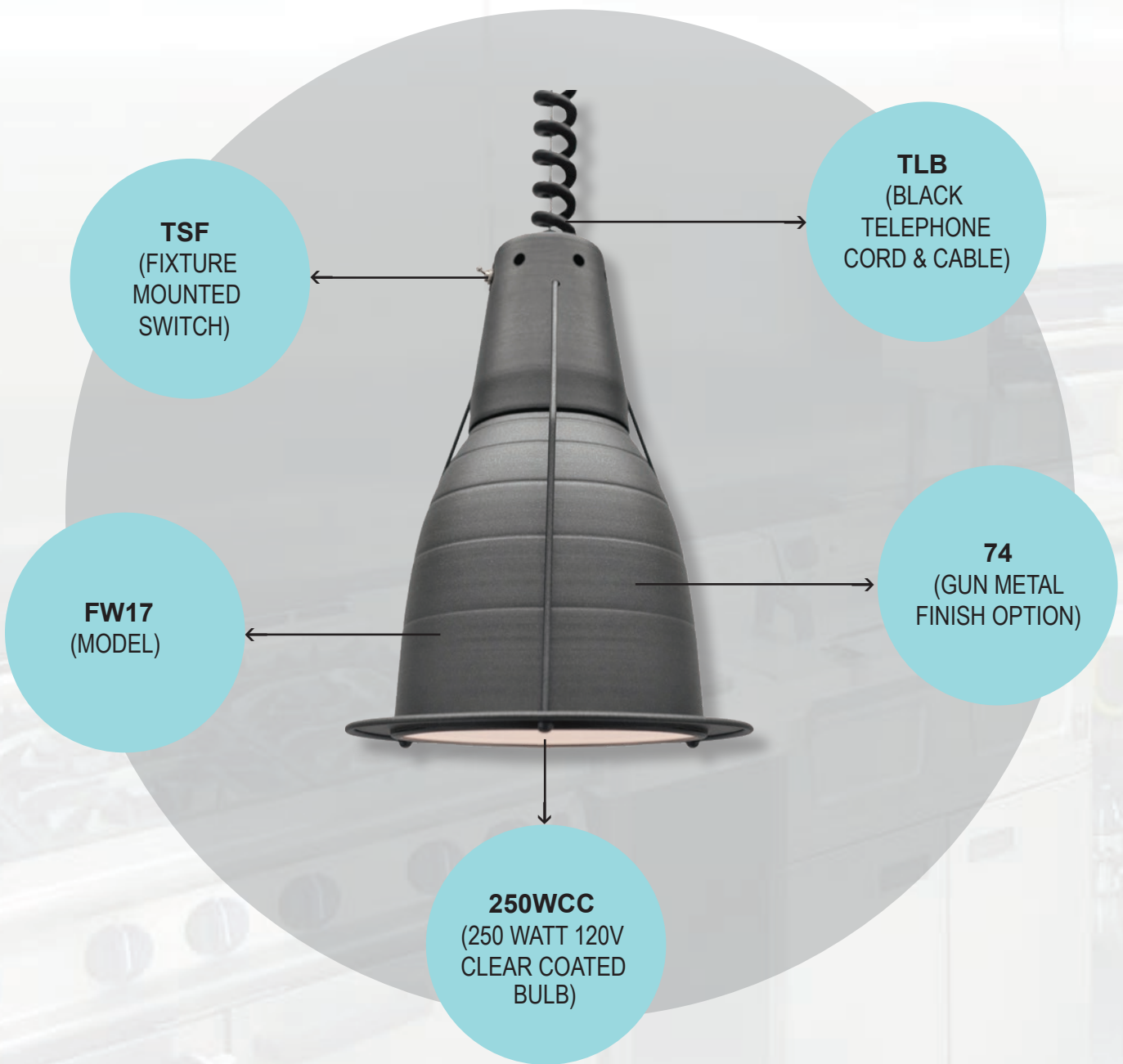

SHADE STYLES



MODEL # FWCYS610



MODEL # FWCY610



MODEL # FWPEH



MODEL # FWPEN



MODEL # FWPEO



FWCYS610

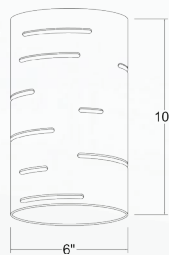

FWCY610



FWPEH

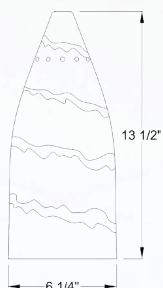

FWPEN



FWPEO



SPECIFICATIONS

● 375 WATT BULBS NOT AVAILABLE MODEL # : FWCYS610, FWCY610, FWPEH, FWPEJ, FW15, FW600, FW16, FW12, FW18, FW1248, FW1272 - FINISH OPTIONS : PB, SB, 40, PN - ACCESSORY : TSF
 ● COPPER, BRASS AND NICKEL FINISH OPTIONS NOT AVAILABLE FOR THE FOLLOWING FIXTURES : FWCYS610, FWCY610, FWPEH, FWPEN, FWPEO, FW18, FW1248, FW1272.

SHADE STYLES



MODEL # FW500



MODEL # FW500B



MODEL # FW501



MODEL # FW90



MODEL # FW11



MODEL # FWD10

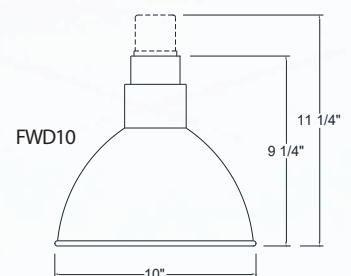
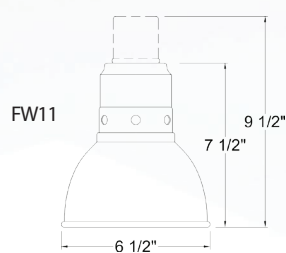
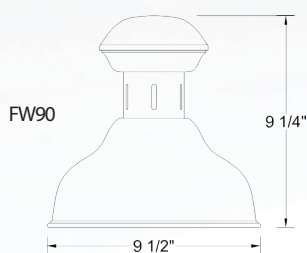
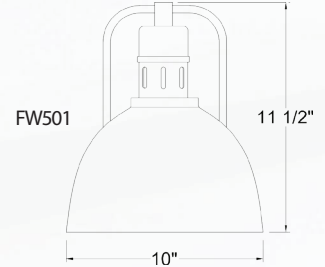
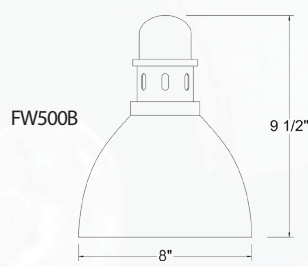
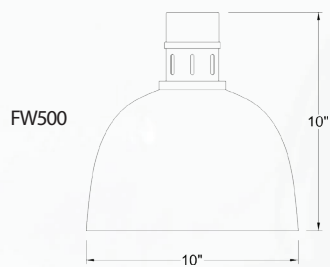

SHADE STYLES



MODEL # FW15



MODEL # FW14



MODEL # FWB10



MODEL # FWH10



MODEL # FW300



MODEL # FW108

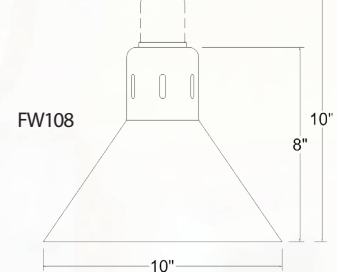
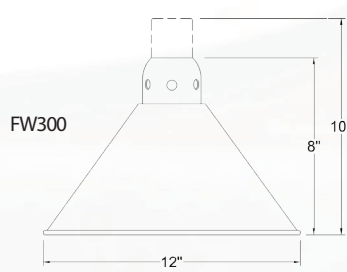
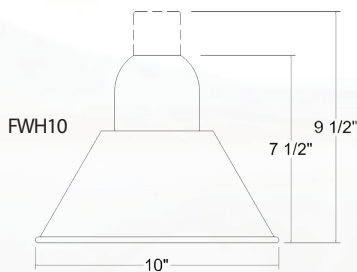
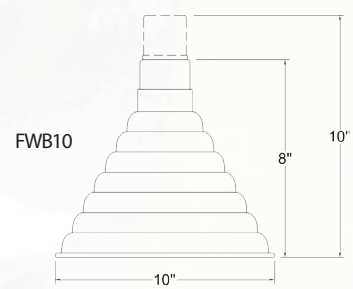
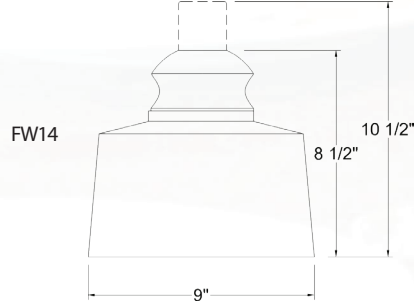
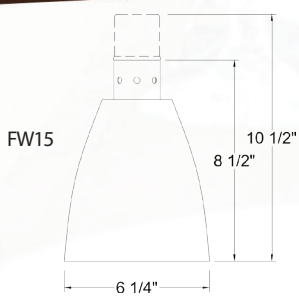

SPECIFICATIONS

375W BULB NOT AVAILABLE FOR MODEL # : FWCYS610, FWCY610, FWPEH, FWPEJ, FW15, FW600, FW16, FW12, FW18, FW1248, FW1272 - FINISH OPTIONS : PB, SB, 40, PN - ACCESSORY : TSF



MODEL # FW400



MODEL # FW16



MODEL # FW12



MODEL # FW600



MODEL # FW601



MODEL # FW13

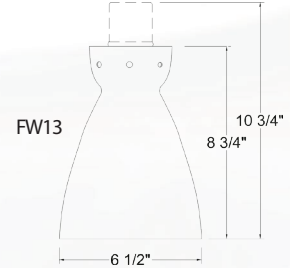
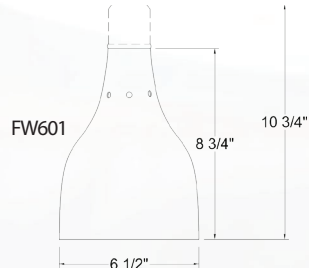
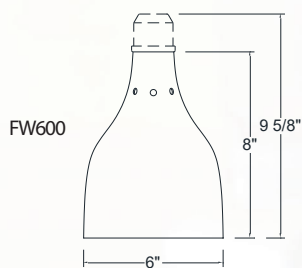
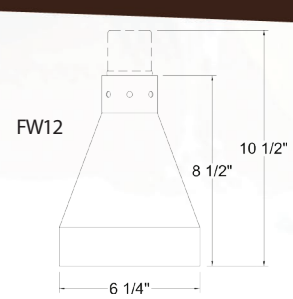
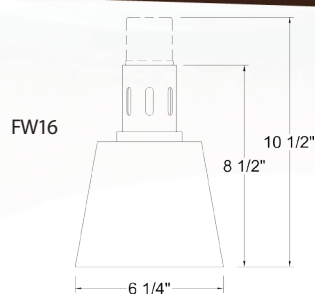
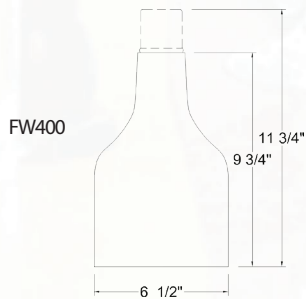

SPECIFICATIONS

● 375 WATT BULBS NOT AVAILABLE MODEL #: FWCY5610, FWCY610, FWPEH, FWPEJ, FW15, FW600, FW16, FW12, FW18, FW1248, FW1272 - FINISH OPTIONS: PB, SB, 40, PN - ACCESSORY: TSF

SHADE STYLES



MODEL # FW18



MODEL # FW17



MODEL # FW3D10/TP40

*CUSTOM OPTIONS AVAILABLE (SHADE STYLE, NUMBER OF SHADES, LENGTH, HEIGHT, ETC.), CALL FOR DETAILS.

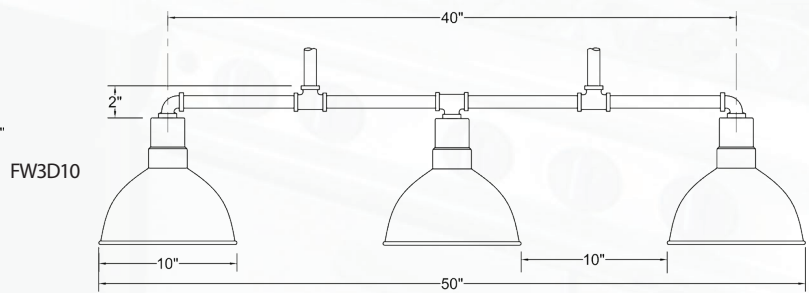
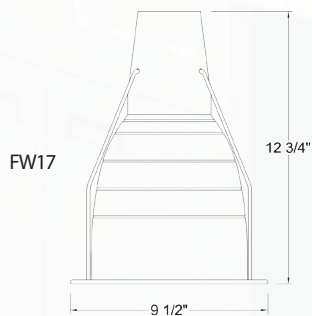
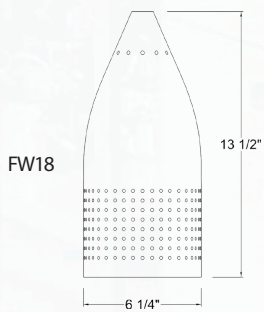

SPECIFICATIONS

- COPPER, BRASS AND NICKEL FINISH OPTIONS NOT AVAILABLE FOR THE FOLLOWING FIXTURES: FWCYS610, FWCY610, FWPEH, FWPEN, FWPEO, FW18, FW1248, FW1272.
- WHEN ORDERING ACCESSORIES FOR THE FW1272 FIXTURE, MUST ORDER A QUANTITY OF 2 (ACCESSORIES: TSC, TSR, TSF).
- 375W BULB NOT AVAILABLE FOR MODEL #: FWCYS610, FWCY610, FWPEH, FWPEJ, FW15, FW600, FW16, FW12, FW18, FW1248, FW1272 - FINISH OPTIONS: PB, SB, 40, PN - ACCESSORY : TSF



*ONLY AVAILABLE WITH STEM MOUNTING

MODEL # FW1248



*ONLY AVAILABLE WITH STEM MOUNTING

MODEL # FW1272

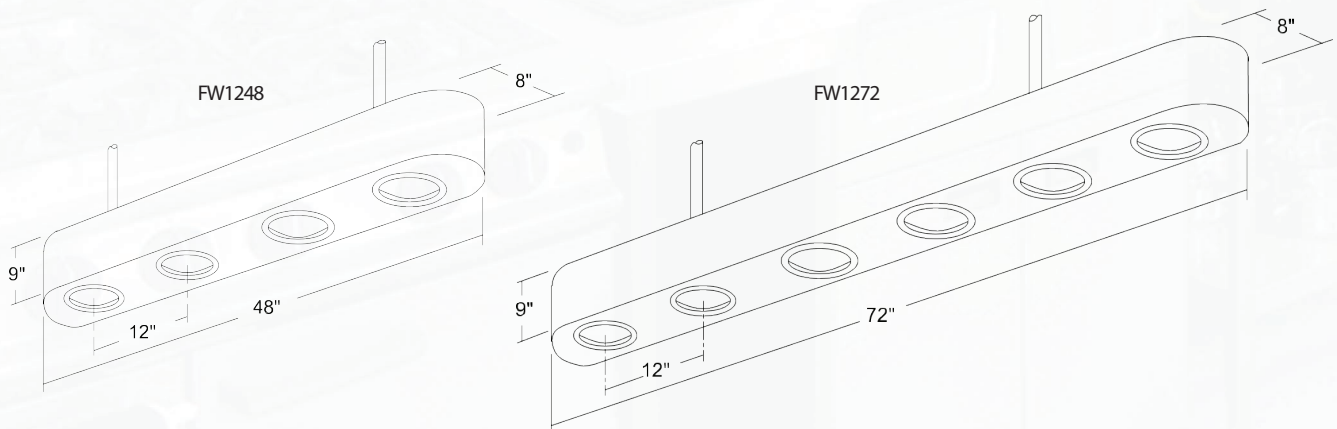

SPECIFICATIONS

- COPPER, BRASS AND NICKEL FINISH OPTIONS NOT AVAILABLE FOR THE FOLLOWING FIXTURES : FWCYS610, FWCY610, FWPEH, FWPEN, FWPEO, FW18, FW1248, FW1272.
- WHEN ORDERING ACCESSORIES FOR THE FW1272 FIXTURE, MUST ORDER A QUANTITY OF 2 (ACCESSORIES : TSC, TSR, TSF).
- 375W BULB NOT AVAILABLE FOR MODEL # : FWCYS610, FWCY610, FWPEH, FWPEJ, FW15, FW600, FW16, FW12, FW18, FW1248, FW1272 - FINISH OPTIONS : PB, SB, 40, PN - ACCESSORY : TSF

MOUNTING OPTIONS



BLC - 6' Black Cord
WHC - 6' White Cord



TCB - 6' Black Cord & Cable
TCW - 6' White Cord & Cable



ST12 - 12" Stem and Swivel
*Customizable lengths available STXX
(XX = inches desired)



PTB - Retractable Black Telephone Cord
PTW - Retractable White Telephone Cord
(Pulley system adjustable from 2' to 5')(TSC not avail.)



FA12 - 12" Flexible Stem
FA18 - 18" Flexible Stem
FA24 - 24" Flexible Stem



TLB - 5' Black Telephone Cord & Cable
TLW - 5' White Telephone Cord & Cable



AM11 - 11" arm mount
(Customizable Lengths. Restrictions apply)

ACCESSORIES



TSC - Canopy Mounted Switch
(Not available with PTB)



TSF - Fixture Mounted Switch
(Not available with 375 watt)



TSR - Remote Switch

- HALO -

(Juno tracks, connectors and adaptors are available upon request)



HADPB - BLACK TRACK ADAPTOR
HADPW - WHITE TRACK ADAPTOR



HTRB4 - 4' Black Track
HTRW4 - 4' White Track



HT286B - BLACK TRACK CONNECTOR
HT286W - WHITE TRACK CONNECTOR

BULBS



Clear Uncoated



Clear Coated



Red Uncoated



Red Coated

Part #	Description
250WRC	250 Watt 120V Red Coated
250WCC	250 Watt 120V Clear Coated
250WRU	250 Watt 120V Red Uncoated
250WCU	250 Watt 120V Clear Uncoated
375WCC	375 Watt 120V Clear Coated
375WCU	375 Watt 120V Clear Uncoated

FINISH OPTIONS

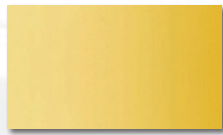

PB - Polished Brass

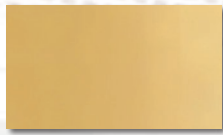

SB - Satin Brass

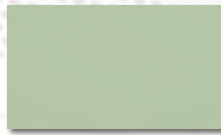

18 - Mint Green

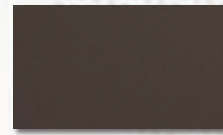

21P - Oil Rubbed Bronze

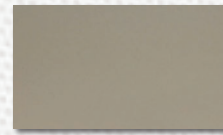

22P - Old Pewter



40 - Copper



41 - Black

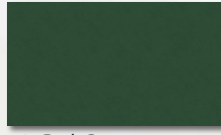

42 - Dark Green

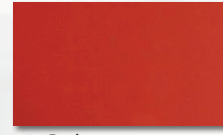

43 - Red

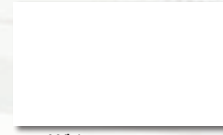

44 - White



45 - Medium Blue



46 - Yellow



48 - Polished Aluminium



50 - Navy Blue



51 - Architectural Bronze



53 - Rust



57 - Polished Aluminium Clear Coat



58 - Satin Aluminium



59 - Coppertone



60 - Canal Green



61 - Anodized Charcoal

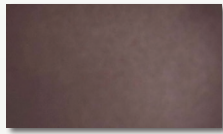

62 - Anodized Bronze

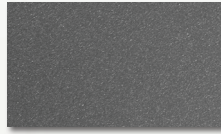

74 - Gun Metal



75 - Distressed Red

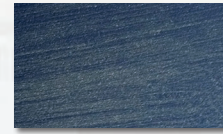

76 - Distressed Blue

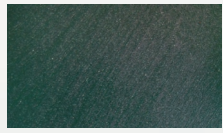

77 - Distressed Green

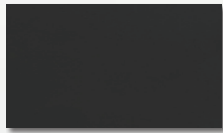

78 - Chalkboard Black



79 - Ghost Orange

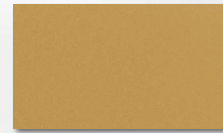

80 - Pale Gold



81 - Metallic Bronze

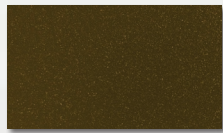

82 - Black Gold

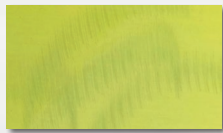

83 - Shocker Green



84 - Faded Blue

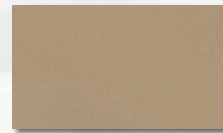

87 - Champagne

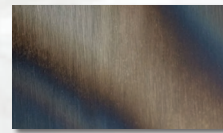

88 - Flamed Steel

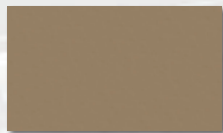

89 - Taupe

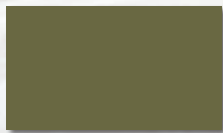

91 - Pacific Pine

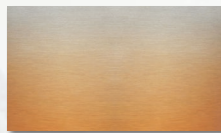

93 - Faded Copper

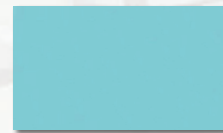

95 - Turquoise

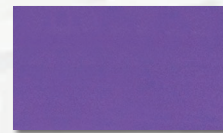

96 - Purple

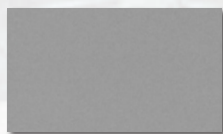

97 - Battleship Grey

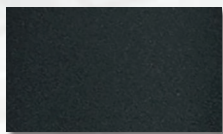

99 - Steel

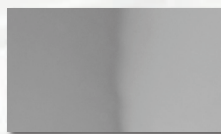

PN - Polished Nickel

SPECIFICATIONS

- COPPER, BRASS AND NICKEL FINISH OPTIONS NOT AVAILABLE FOR THE FOLLOWING FIXTURES : FWCYS610, FWCY610, FWPEH, FWPEN, FWPEO, FW18, FW1248, FW1272.
- WHEN ORDERING ACCESSORIES FOR THE FW1272 FIXTURE, MUST ORDER A QUANTITY OF 2 (ACCESSORIES : TSC, TSR, TSF).
- 375 WATT BULBS NOT AVAILABLE FOR THE FOLLOWING FIXTURES : FWCYS610, FWCY610, FWPEH, FWPEJ, FW15, FW600, FW16, FW12, FW18, FW1248, FW1272. FINISH OPTIONS : PB, SB, 40, PN. ACCESSORY : TSF
- DO NOT ADD TRACK, ADAPTOR, CONNECTOR OR REMOTE SWITCH TO PART NUMBER WHEN ORDERING, USE A SEPERATE LINE ITEM.

*Your
Commercial & Retail
lighting solution!*



MADE IN U.S.A..



BASELITE CORPORATION
12260 EAST END AVE. CHINO, CA 91710

PHONE: 909-548-4554 TOLL FREE: 877-999-1990 FAX: 909-548-4774
WEBSITE: WWW.BASELITE.COM EMAIL: SALES@BASELITE.COM