

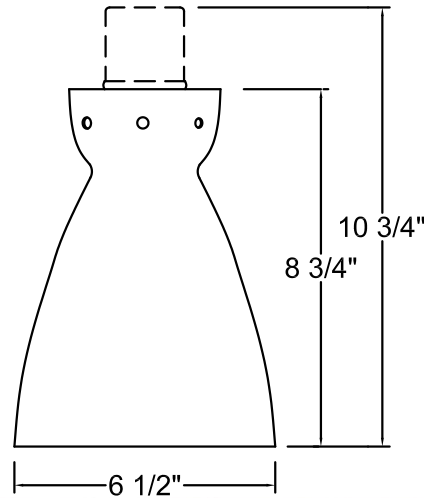

FOOD WARMER



FW13/59/ST12



MODEL: FW13

PREPARED BY: _____

TYPE: _____

JOB NAME: _____

DATE: _____

CERTIFICATION: UL Listed NSF Approved

Finish – Five stage pretreatment process, coated with a lead free TGI C polyester powder coat finish. White is standard inside reflectors. See color chart below for color options. Some finish options are not available for certain fixtures. Custom color options are available upon request.

Lamp – Food Warmer – medium base porcelain socket, copper shell with nickel plate, rated 250v, 660W. 250 or 375 Watt Infrared R40 Bulb. Available in clear or red, shatter proof coated or non-coated.

Decorative Applications – Can accommodate LED, Compact Fluorescent, Incandescent, or High Intensity Discharge (H.I.D.).

Mounting – Available with cord (BLC, WHC), cord and cable (TCB, TCW), retractable telephone cord and cable (PTB, PTW), non-retractable telephone cord and cable (TLB, TLW), flexible stem (FA), rigid stem (ST), or horizontal arm (AM). Supplied with 1/2" tapped hub with ST, AM, and FA. FA available in 12", 18", or 24". ST standard 12", available in custom lengths, minimum 6". AM standard 11", available in custom lengths, restrictions apply. ST finish will match fixture finish. Fixture will come with 2" junction cap (see drawing above) with all cord mounts and/or fixture mounted switch (TSF). Junction cap finish will match cord (41 black/44 white) with most finishes. Junction cap will match fixture with finishes PB, SB, PN, 40, 57 and 58. Fixtures are pre-wired with 48" or 96" leads or 96" cord.

Accessories - Available with canopy mounted (TSC), fixture mounted (TSF), or remote switch (TSR). Available with track adapter (ADP) and track (HTR). HTR available in 4', 8' or 12', black or white.

Reflector – Spun from heavy gauge 1100-0 aluminum, ranging in thickness from .050 to .125. Copper is spun from .040 gauge 110 soft alloy. Brass is spun from 40 gauge

MODEL #	FINISH	LIGHT SOURCE				MOUNTING OPTIONS	ACCESSORIES
		INC					
FW13	PB* ² , SB* ² , PN ²	250WRC				BLC, WHC	TSC
	21P, 40* ² , 41	250WCC				TCB, TCW	TSF ²
	42, 43, 44, 45	250WRU ¹				TLB, TLW	TSR
	48*, 49*, 50, 51	250WCU ¹				PTB, PTW	HTRB-4
	52, 53, 57*, 58*	375WRC				FA12, FA18, FA24	HTRW-4
	59, 61*, 62*, 70*	375WCC				ST12	HTRB-8
	71*, 74, 75, 76	375WRU ¹				AM11	HTRW-8
	79, 81, 84*, 87	375WCU ¹				TP	HTRB-12
	90, 93*, 95, 97						HTRW-12
							ADP

* same finish color inside and out. 1. not NSF approved. 2. not available with 375 watt bulb. .SUBJECT TO MODIFICATION WITHOUT NOTICE.



BASELITE CORPORATION
12260 EAST END AVE.
CHINO, CA 91710

PH: 877-999-1990
WEB: WWW.BASELITE.COM
EMAIL: SALES@BASELITE.COM

