

BASELITE CORPORATION



COMMERCIAL / RETAIL LIGHTING

COMMERCIAL LIGHTING



DHS16/19/TRS



DHS22/48



PHS16/61



PHSA22/48/ARFR



PHSA16/53/ARFL

COMMERCIAL LIGHTING



PHS22/61



DHS16/48



DHSA22/61/ARFR

DHS16

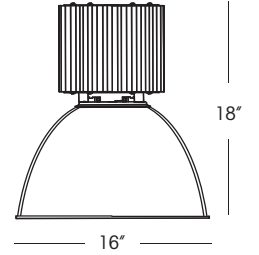

PHS16

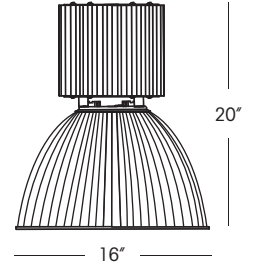

DHS22

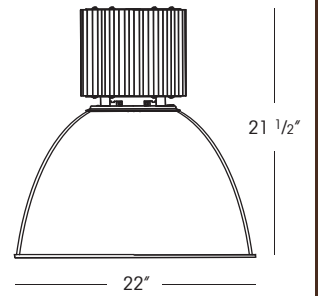

PHS22

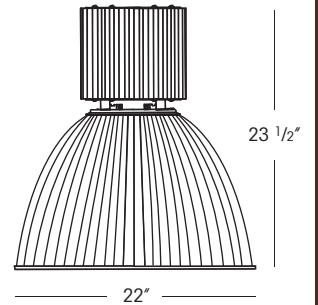

Model #	Finish	Lamps	Mounting	Options	Accessories
PHS16	19-Ant. Alum.	4x26, 32, 42W	HB3-3/4" Hub	FS-Fusing	DRL-Drop Lens
DHS16	41-Black	6x26, 32, 42W	HKBC-3/4" Hook w/8' Black Cord	DM-Dimming Ballast	CRL-Curved Lens
PHSA16	44-White	100WMH	HKWC-3/4" Hook w/8' White Cord	EM-Emergency Ballast	FLE-Flat Lens
DHSA16	48-Pol. Alum.	150WMH		MS2-2Switch Leg	BRC-Ballast Retainer Chain
	53-Rust	175WMH		MS3-3Switch Leg	JSL3-3/4" Joint Aligner for 4-S Box
	58-Sat. Alum.			MS4-4Switch Leg	JOL3-3/4" Joint Aligner for 4-O Box
PHS22	59-Coppertone	4x26, 32, 42W			FWG-Full Wire Guard
DHS22	61-Charcoal	6x26, 32, 42W			TRS-Top Ring Shield
PHSA22	62-Ano. Brz.	8x26, 32, 42W			BRS-Btm. Ring Shield
DHSA22	74-Gun Metal	100WMH			ARFL-Arms w/Flat Lens
		150WMH			ARFR-Arms w/Ring
		175WMH			BLE-Banded Flat Lens

COMMERCIAL LIGHTING

FA12

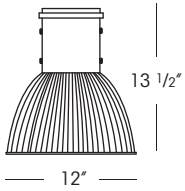

FAP22/62



FAP16/48

FA16

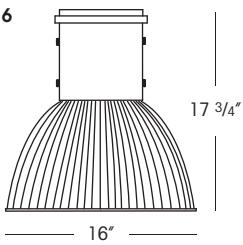

FAP12/41

FA22

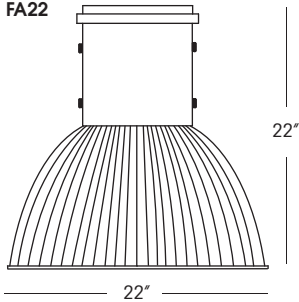

FA16/53



FA22/58

Model #	Finish	Lamps	Mounting	Options	Accessories	
FA12	41-Black	1x26, 32, 42W	CBLC-8' Blk. Cord, Cable and Canopy	FS-Fusing	DRL-Drop Lens	
FAP12	44-White					CWHC-8' Wht. Cord, Cable & Canopy
FA16 FAP16	48-Pol. Alum.	1x26, 32, 42W	STC-Stem Canopy	EM-Emergency Ballast	FLE-Flat Lens	
	53-Rust					2x26, 32, 42W
	58-Sat. Alum.	4x26, 32, 42W	STXX- Stem 1/2" NPT			
	59-Coppertone	100WMH				150WMH
	61-Charcoal	175WMH				
	62-Ano. Brz.					
74-Gun Metal						
FA22		4x26, 32, 42W	HB3-3/4" Hub		JSL3-3/4" Joint Aligner for 4-S Box JOL3-3/4" Joint Aligner for 4-O Box FWG-Full Wire Guard TRS-Top Ring Shield BRS-Btm. Ring Shield BLE-Banded Flat Lens	
FAP22		6x26, 32, 42W	HKBC-3/4" Hook w/8' Black Cord			
		8x26, 32, 42W	HKWC-3/4" Hook w/8' White Cord			
		100WMH				
		150WMH				
		175WMH				

COMMERCIAL LIGHTING



RP16/61



RP22/62



RD16/19



RP22/48



RD12/53

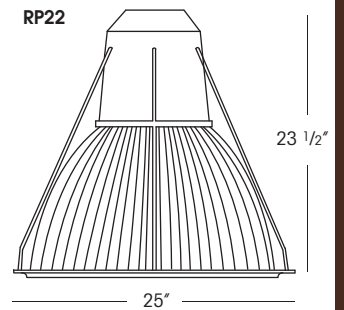
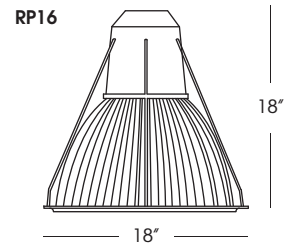
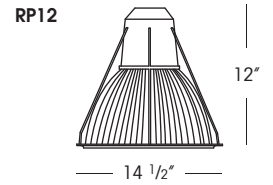

Model #	Finish	Lamps	Mounting	Options	Accessories
RP12 RD12	19-Ant. Alum. 41-Black 44-White	1x26, 32, 42W	CBLC-8' Blk. Cord, Cable and Canopy CWHC-8' Wht. Cord, Cable and Canopy	FS-Fusing DM-Dimming Ballast EM-Emergency Ballast	NA
RP16 RD16	48-Pol. Alum. 51-Arch. Brz. 53-Rust 58-Sat. Alum. 59-Coppertone 61-Charcoal	1x26, 32, 42W 2x26, 32, 42W 4x26, 32, 42W 100WMH* 150WMH* 175WMH*	SLC-Slope Ceiling Canopy STXX- Stem 1/2" NPT		
RP22 RD22	62-Ano. Brz. 74-Gun Metal	4x26, 32, 42W 6x26, 32, 42W 100WMH* 150WMH* 175WMH*	HB3-3/4" Hub HKBC-3/4" Hook w/8' Black Cord HKWC-3/4" Hook w/8' White Cord	*IR-Remote Ballast or BC-Ballast In Canopy	

COMMERCIAL LIGHTING

PC12

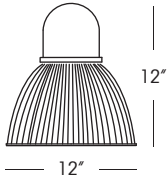

PC16

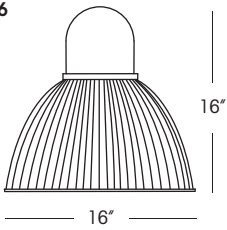

PC22

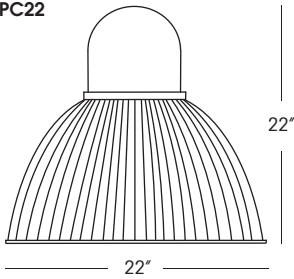

PC16/58/LL/BLC



PC22/58/STXX/STC/BRS



PC12/52/BLC/CRL



PC12/53/BLC

Model #	Finish	Lamps	Mounting	Options	Accessories
PC12	41-Black 44-White 48-Pol. Alum.	1x26, 32, 42W 2x26, 32, 42W 150W Inc	BLC-8' Black Cord and Canopy WHC-8' White Cord/Canopy STC-Stem Canopy	FS-Fusing DM-Dimming Ballast EM-Emergency Ballast	DRL-Drop Lens CRL-Curved Lens FLE-Flat Lens
PC16	51-Arch Brz. 52-Patina 53-Rust 58-Sat. Alum. 59-Coppertone 61-Charcoal	1x26, 32, 42W 2x26, 32, 42W 4x26, 32, 42W 100WMH* 150WMH* 175WMH*	SLC-Slope Ceiling Canopy STXX- Stem 1/2" NPT TCB- 8' Black Cord & Cable TCW- 8' White Cord & Cable		BLE-Flat Lens with Bands FWG-Full Wire Guard TRS-Top Ring Shield BRS-Btm. Ring Shield
PC22	62-Ano. Brz.	2x26, 32, 42W 4x26, 32, 42W 6x26, 32, 42W 100WMH* 150WMH* 175WMH*	HB3-3/4" Hub HKBC-3/4" Hook w/8' Black Cord HKWC-3/4" Hook w/8' White Cord	*IR-Remote Ballast or BC-Ballast In Canopy	

COMMERCIAL LIGHTING



TR/FC/58/TCB



TR1/PR/74/ARFL



TR1/PR/61



TR/D/48/TLB



TR/D/41-43/TCB/ARFR



TR/FR/61/3CBL/ARFL

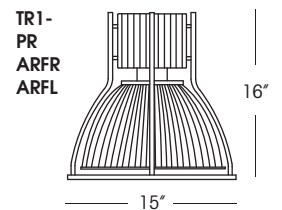
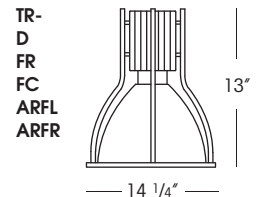
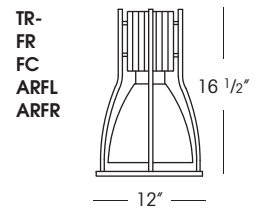
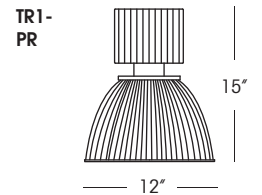
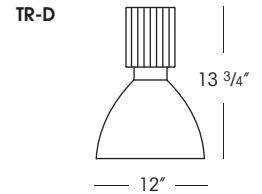
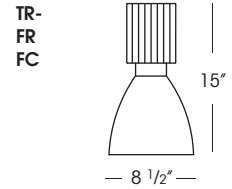

Model #	Shade	Finish	Lamps	Mounting	Options	Accessories
TR	FR-Frosted FC-Frosted Charcoal D-Metal Dome	41-Black 43-Red 44-White 48-Pol. Alum.	1x26, 32, 42W 150W Inc	TLB-8' Tele. Blk. Cord/Cable TLW-8' Tele. Wht. Cord/Cable TCB-8' Blk. Cord/Cable TCW-8' Wht. Cord/Cable	DM-Dimming Ballast EM-Emergency Ballast	ARFL-Arms w/Flat Lens ARFR-Arms w/Flat Ring
TR1	PR-Prismatic FPR-Frosted Prismatic	51-Arch. Brz. 52-Patina 53-Rust 58-Sat. Alum. 59-Coppertone 61-Charcoal 62-Ano. Brz. 74-Gun Metal	1x26, 32, 42W 2x26, 32, 42W 150W Inc	3CBLC-3-Blk. Cable & Cord 3CWHC-3' Wht. Cable & Cord		

COMMERCIAL LIGHTING

PD12

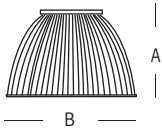

HD

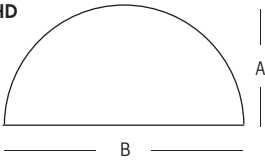

OB

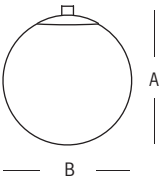

HD16/58/TCB



OB14/58/ST



HD20/58/TCB



PD12/58/BLC

Model #	Height (A)	Width (B)
PD12	8"	12"
PD16	11"	16"
HD12	6"	12"
HD16	8"	16"
HD20	10"	20"
HD24	12"	24"
OB14	14"	14"
OB16	16"	16"
OB18	18"	18"

Model #	Finish	Lamps	Mounting	Options	Accessories
HD12	41-Black	1x26, 32, 42W	CFBLC-CF 8' Blk. Cord w/Ballast Canopy	DM-Dimming Ballast	FLE-Flat Lense
PD12	44-White	150W Inc	CFWHC-CF8' Wht. Cord w/Ballast Canopy	EM-Emergency Ballast	LGR-Louvered Grill
PD16	48-Pol. Alum.	1x26, 32, 42W	CFSTC-Ballast Canopy for Stem		
HD20	51-Arch. Brz.	2x26, 32, 42W	CFSLC-Ballast Canopy for Slope Ceiling Canopy		
HD24	52-Patina	150W Inc	TCB-8' Black Cord & Cable		
OB14	53-Rust		TCW-8' White Cord & Cable		
OB16	58-Sat. Alum.				
OB18	59-Coppertone		STXX- Stem 1/2" NPT		
	61-Charcoal		BLC-8' Black Cord & Cable		
	62-Ano. Brz.		WHC-8' white Cord & Cable		
	74-Gun Metal				

COMMERCIAL LIGHTING



CD12/44



DP12/44-49



CD14/61



CD16/61



C18/59



C16/74

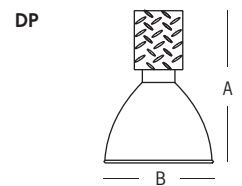
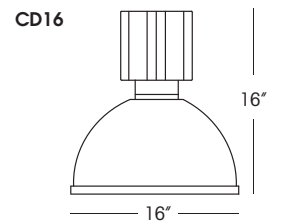
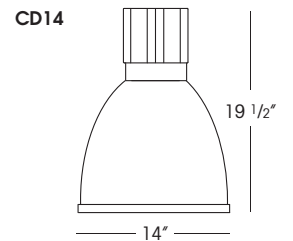
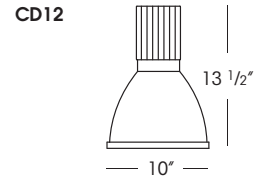
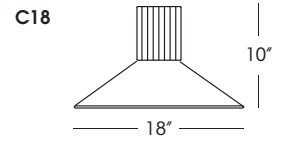
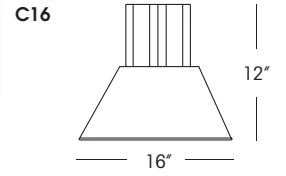

Model #	Height (A)	Width (B)
DP12	14"	12"
DP16	15"	16"

Model #	Finish	Lamps	Mounting	Options	Accessories
C16	41-Black	1x26, 32, 42W	BLC-8' Black Cord	DM-Dimming Ballast	FLE-Flat Lense
C18	44-White		WHC-8' White Cord	EM-Emergency Ballast	LGR-Louvered Grill
CD12	48-Pol. Alum.	1x26, 32, 42W	STC-Canopy for Stem		
CD14	51-Arch. Brz.	2x26, 32, 42W	SLC-Canopy for Slope Ceiling Canopy		
CD16	52-Patina	150W Inc	TLB-8' Black Telephone Cord		
DP12	53-Rust		TLW-8' White Telephone Cord		
DP16	58-Sat. Alum.		TCB-8' Black Cord & Cable		
	59-Coppertone		TCW-8' White Cord & Cable		
	61-Charcoal				
	62-Ano. Brz.				
	74-Gun Metal				

COMMERCIAL LIGHTING

QSD16

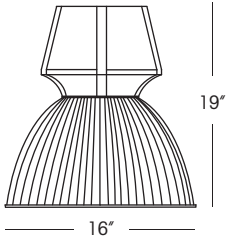

QSD16/61/HB3



QSP22/48/HB3/FWG

QSP22

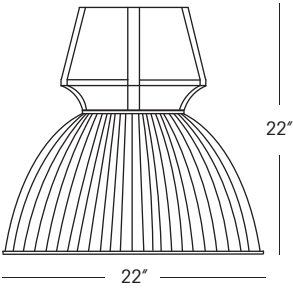

QSP22/74/HB3/LL



QSP16/44/HB3

Model #	Finish	Lamps	Mounting	Options	Accessories
QSP16	41-Black	4x26, 32, 42W	HB3-3/4" Hub	FS-Fusing	DRL-Drop Lens
QSD16	44-White	6x26, 32, 42W	HKBC-3/4" Hook w/8' Blk. Cord	DM-Dimming Ballast	CRL-Curved Lens
	48-Pol. Alum.	100WMH	HKWC-3/4" Hook w/8' Wht. Cord	EM-Emergency Ballast	FLE-Flat Lens
	51-Arch. Brz.	150WMH	STXX-Stem 3/4" NPT	MS2-2Switch Leg	BRC-Ballast Retainer Chain
	52-Patina	175WMH		MS3-3Switch Leg	JSL3-3/4" Joint Aligner for 4-S Box
	53-Rust			MS4-4Switch Leg	JOL3-3/4" Joint Aligner for 4-O Box
QSP22	58-Sat. Alum.	4x26, 32, 42W			FWG-Full Wire Guard
QSD22	59-Coppertone	6x26, 32, 42W			TRS-Top Ring Shield
	61-Charcoal	8x26, 32, 42W			BRS-Btm. Ring Shield
	62-Ano. Brz.	100WMH			LL-Conical Lens
	74-Gun Metal	150WMH			BLE-Flat Lens with Band
		175WMH			

PHS16-16" Clear Prismatic Acrylic Dome

6 Lamp 42W Compact Fluorescent - 4 Pin TRT
Lumen Rating: 25600 LMS
Efficiency: 66.6% Spac. Crit. 1.8

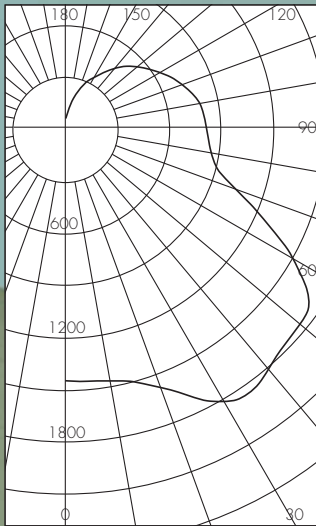

Intensity (Candlepower) Summary

Angle	Mean CP	LMS.	Angle	Mean CP	LMS.
0	1448		90	813	
5	1456	142	95	808	880
10	1470		100	796	
15	1500	429	105	773	815
20	1575		110	738	
25	1695	787	115	700	693
30	1810		120	657	
35	1855	1153	125	615	552
40	1814		130	572	
45	1766	1372	135	525	407
50	1760		140	475	
55	1709	1507	145	423	267
60	1528		150	370	
65	1295	1284	155	316	148
70	1075		160	262	
75	919	989	165	204	60
80	857		170	152	
85	832	907	175	99	12
90	813		180	63	

Zonal Lumens And Percentages

Zone	Lumens	% Lamp	% Luminaire
0-30	1357	7.07	10.95
0-40	2511	13.08	20.25
0-60	5390	28.07	43.46
0-90	8570	44.64	69.10
40-90	6059	31.56	48.85
60-90	3180	16.56	25.64
90-180	3832	19.96	30.90
0-180	12403	64.60	100.00

Luminaire Summary

Angle	Mean CD / SQ. M.
45	15722
55	15369
65	12142
75	9303
85	9449

PHS22-22" Clear Prismatic Acrylic Dome

8 Lamp 42W Compact Fluorescent - 4 Pin TRT
Lumen Rating: 19200 LMS
Efficiency: 64.6% Spac. Crit. 1.8

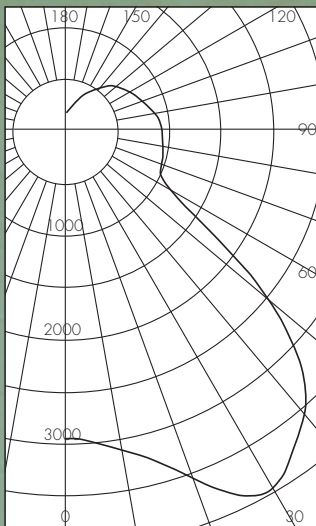

Intensity (Candlepower) Summary

Angle	Mean CP	LMS.	Angle	Mean CP	LMS.
0	2942		90	944	
5	2985	293	95	936	1016
10	3095		100	909	
15	3253	933	105	865	916
20	3515		110	824	
25	3843	1767	115	796	787
30	3975		120	759	
35	3793	2371	125	727	650
40	3581		130	687	
45	3218	2445	135	637	492
50	2628		140	574	
55	1852	1675	145	505	318
60	1241		150	426	
65	1033	1053	155	357	169
70	989		160	303	
75	980	1035	165	247	72
80	966		170	201	
85	947	1036	175	198	19
90	944		180	213	

Zonal Lumens And Percentages

Zone	Lumens	% Lamp	% Luminaire
0-30	2994	11.70	17.56
0-40	5365	20.96	31.47
0-60	9485	37.05	55.64
0-90	12609	49.26	73.96
40-90	7244	28.30	42.49
60-90	3123	12.20	18.32
90-180	4439	17.34	26.04
0-180	17049	66.60	100.00

Luminaire Summary

Angle	Mean CD / SQ. M.
45	15052
55	8820
65	5169
75	5337
85	5851

FS - Fusing

DM - Dimming Ballast-Provided with Advance Transformer MARK X
(for ballast information contact ballast manufacturer)

EM - Emergency Ballast

BRC - Ballast Retainer Chain

Multiple Switching

MS2 - 2 Switch Legs

MS3 - 3 Switch Legs

MS4 - 4 Switch Legs-not available with cord mount

OPTIONS

ACCESSORIES

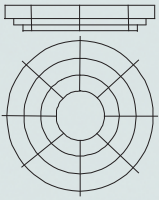

LGR
Louvered Grill

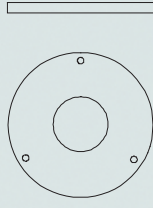

ARFL
Flat Diffuser

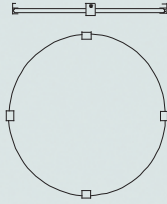

FLE
Flat Lens with Clips

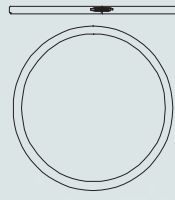

BLE
Flat Lens with Band



LL
Conical Lens

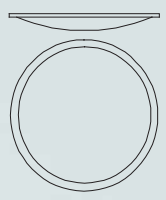

CRL
Curve Lens



DRL
Drop Lens



BRS
Bottom Ring Shield



TRS
Top Ring Shield

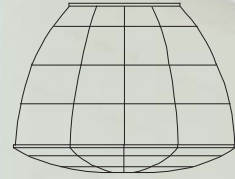

FWG
Full Wire Grill

MOUNTING

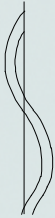

CBLC
8' Black Cord, Cable and Canopy



TLB
8' Telephone Cable



TCB
8' Black Cord, 100P, Cable and Canopy



BLC
8' Black Cord and Canopy

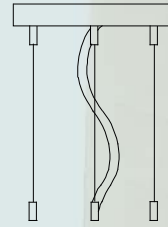

3CBLC
3 Cable and Black Cord and Canopy



ST-XX
Stem-3/4" NPT



CWHC
8' White Cord, Cable and Canopy



TLW
8' White Telephone Cable



TCW
8' White Cord, 100P, Cable and Canopy



WHC
8' White Cord and Canopy

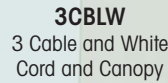

3CBLW
3 Cable and White Cord and Canopy

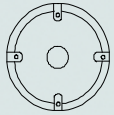

STC
Stem Canopy



SLC
Slope Ceiling Canopy



HB3
3/4" Hub



HKBC
3/4" Hook with 8' Black Cord



HKWC
3/4" Hook with 8' White Cord



JSL3
Joint Aligner for 4S Box

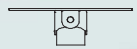

JOL3
Joint Aligner for 4O Box

FINISHES



19-Ant. Alum.



41-Black

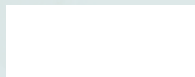

44-White



48-Pol. Alum.

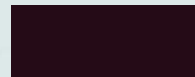

51-Arch. Bronze



52-Patina



53-Rust



58-Satin Alum.



59-Coppertone

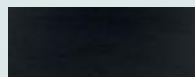

61-Charcoal

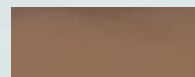

62-Anod. Bronze



74-Gun Metal

BASELITE CORPORATION

12260 East End Ave., Chino CA 91710

Toll Free: (877) 999-1955 Tel: (909) 548-4554 Fax: (909) 548-4774

Website: www.baselite.com E-mail: sales@baselite.com